

REV.	DESCRIPTION	DRAWN	DATE
1	INITIAL RELEASE	TIM	2022/08/15

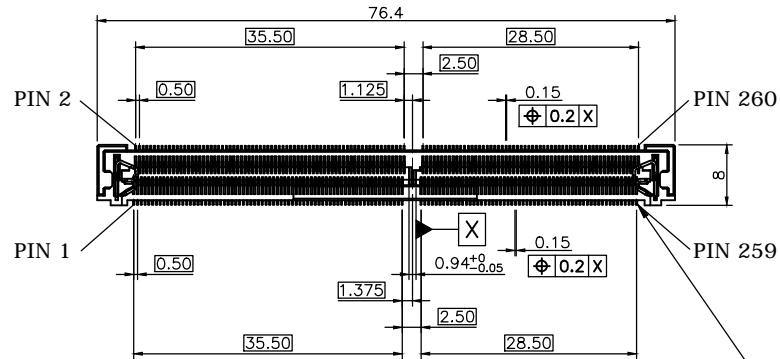

SPECIFICATION:

1. ELECTRICAL

- 1.1 Current Rating: 0.5A per pin
- 1.2 Voltage Rating: 25V AC
- 1.3 Contact Resistance: 55mΩ max.
- 1.4 Insulation Resistance: 500MΩ
- 1.5 Dielectric Withstanding Voltage: 300VAC

2.3 Extraction Force: 30N max.

3. ENVIRONMENTAL

- 3.1 Operating temperature range: -55°C~+85°C
- 3.2 Storage temperature range: -55°C~+85°C

2. MECHANICAL

- 2.1 Durability: 25 Cycle
- 2.2 Insertion Force: 30N max.

4. SOLDER ABILITY

- 4.1 Recommended IR-Reflow Temperature: 260°C

DATE CODE: YWWD

Y: YEAR
 WW: WEEK (01~52)
 D: DAY (1~7)

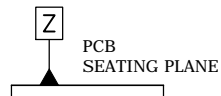
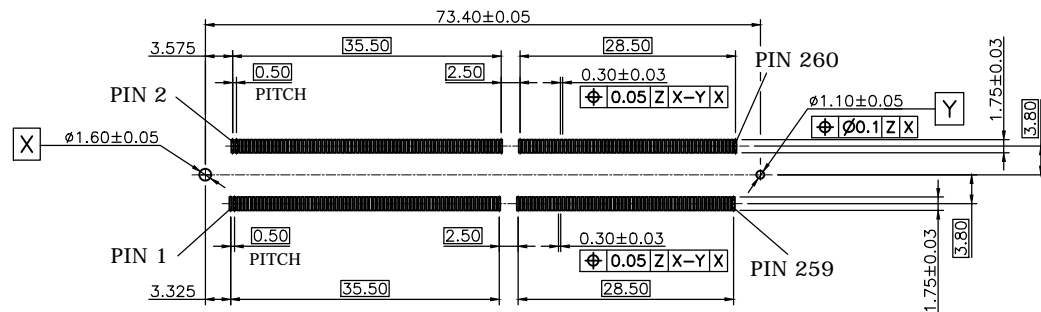
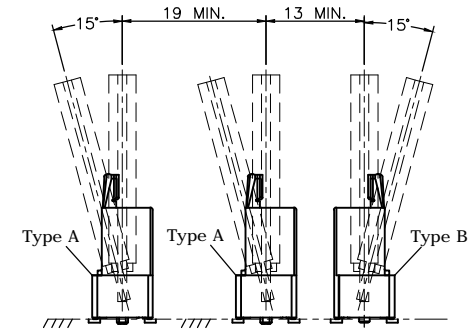
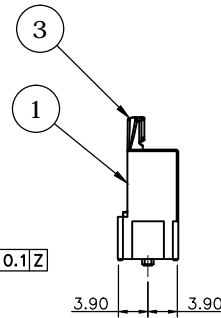
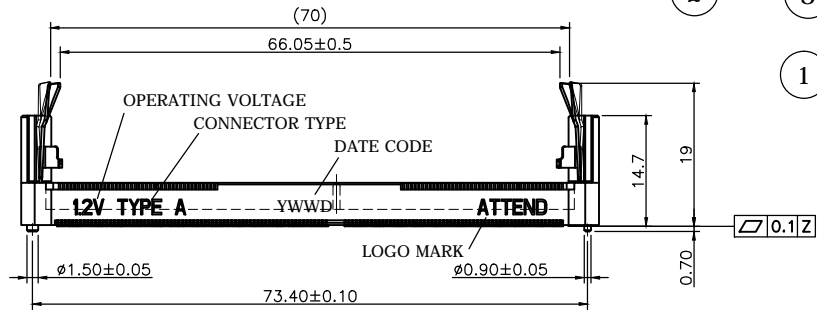

RECOMMENDED PCB LAYOUT (TOP VIEW)
GENERAL TOLERANCE: ±0.05mm

RECOMMENDED SOCKET MOUNTING LAYOUT

3	LATCH	STAINLESS STEEL	
2	CONTACT	PHOSPHOR BRONZE, GOLD FLASH	
1	HOUSING	LCP, UL94V-0, BLACK	
NO.	PART NAME	DESCRIPTION	
UNLESS OTHERWISE SPECIFIED TOLERANCE			
UNIT:	DECIMAL	LINEAR	ANGLES
	X	±0.50	±5°
	X.X	±0.25	±3°
	X.XX	±0.12	±1°
www.attend.com.tw			
DRAWN	Tim	2022/08/15	
CHECKED	Fros	2022/08/15	
APPROVED	Ken	2022/08/15	
SCALE	SHEET	SIZE	DRAWN NAME:
1/1	1/1	A4	DDR4 Vertical Socket
		FILE NAME	Type A for 260P DDR SO DIMM
		PRODUCT NO.	124B-150A02
		FILE NAME	124B-150A02_B_1



REV.	DESCRIPTION	DRAWN	DATE
1	INITIAL RELEASE	FROS	2017/02/23
1.1	CORRECTED	TIM	2022/08/15

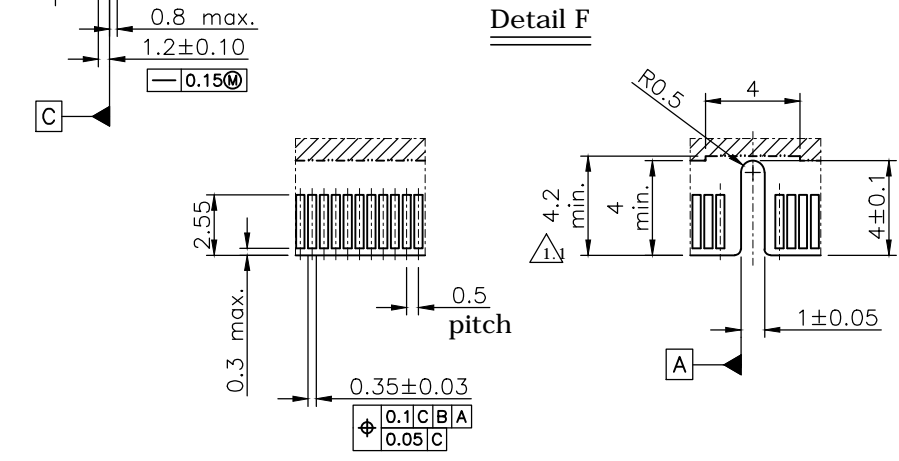
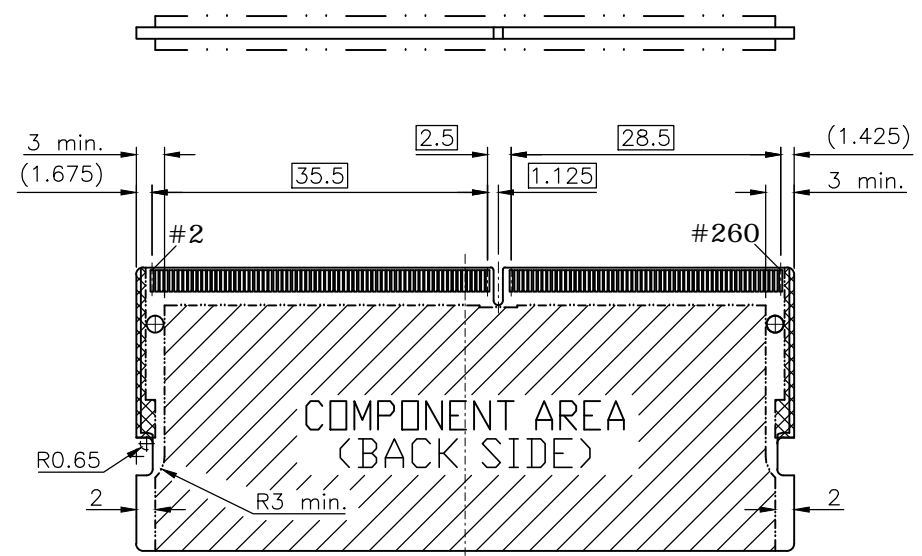
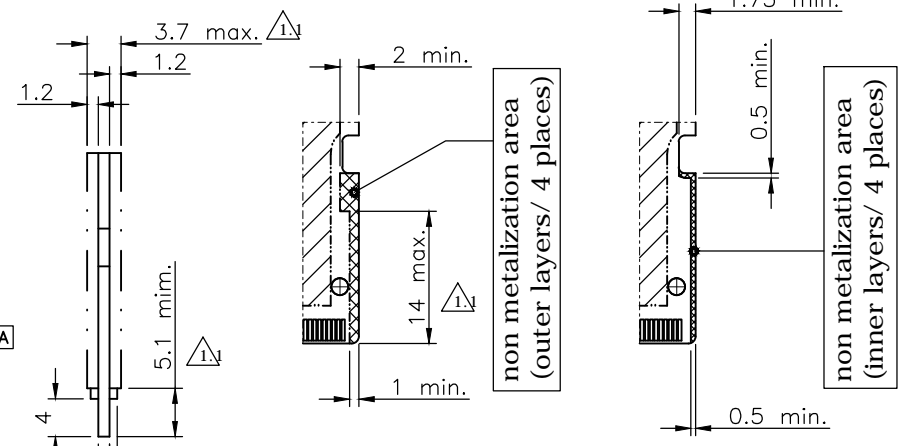
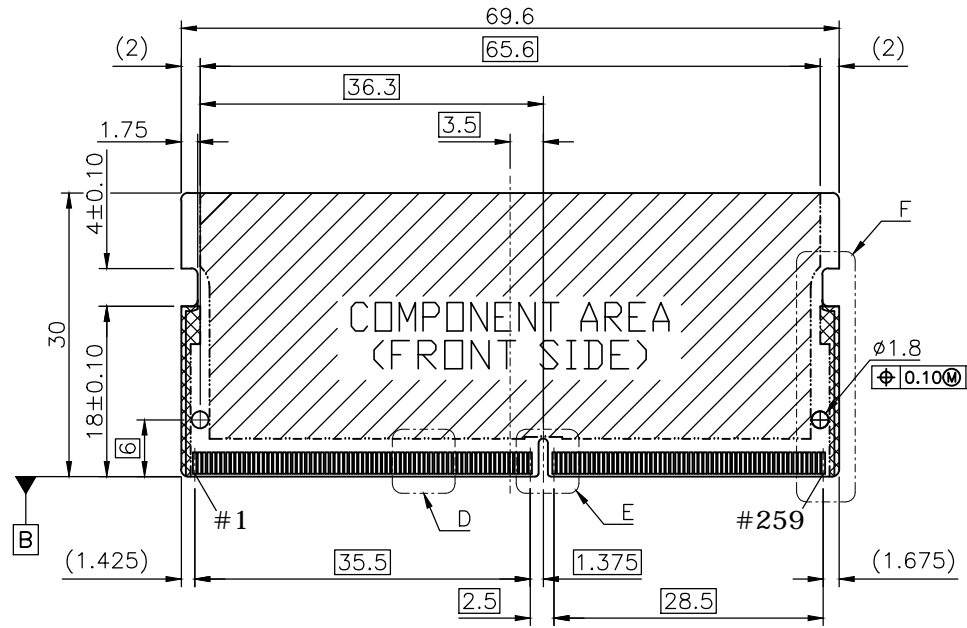



Note: tolerance on dimensions is ±0.15 unless otherwise specified.

UNLESS OTHERWISE SPECIFIED TOLERANCE					
UNIT:	DECIMAL	LINEAR	ANGLES		
mm	X.	±0.50	±5°	www.attend.com.tw	
	X.X	±0.25	±3°		
	X.XX	±0.12	±1°		
DRAWN	Fros	2017/02/23	DRAWN NAME: DDR4 SODIMM CARD SPEC.		
CHECKED	Tim	2017/02/23	PRODUCT NO.		
APPROVED	Ken	2017/02/23	FILE NAME 124-CARD_B_1.1		
SCALE	1.25/1	SHEET 1/1	SIZE A4		

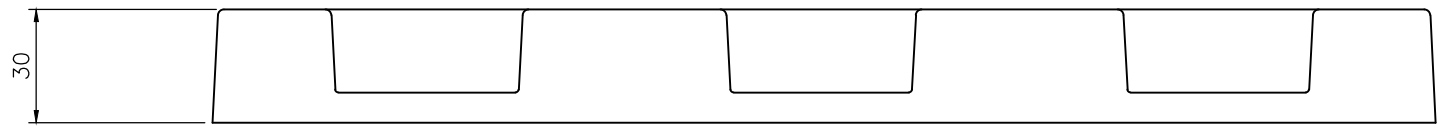
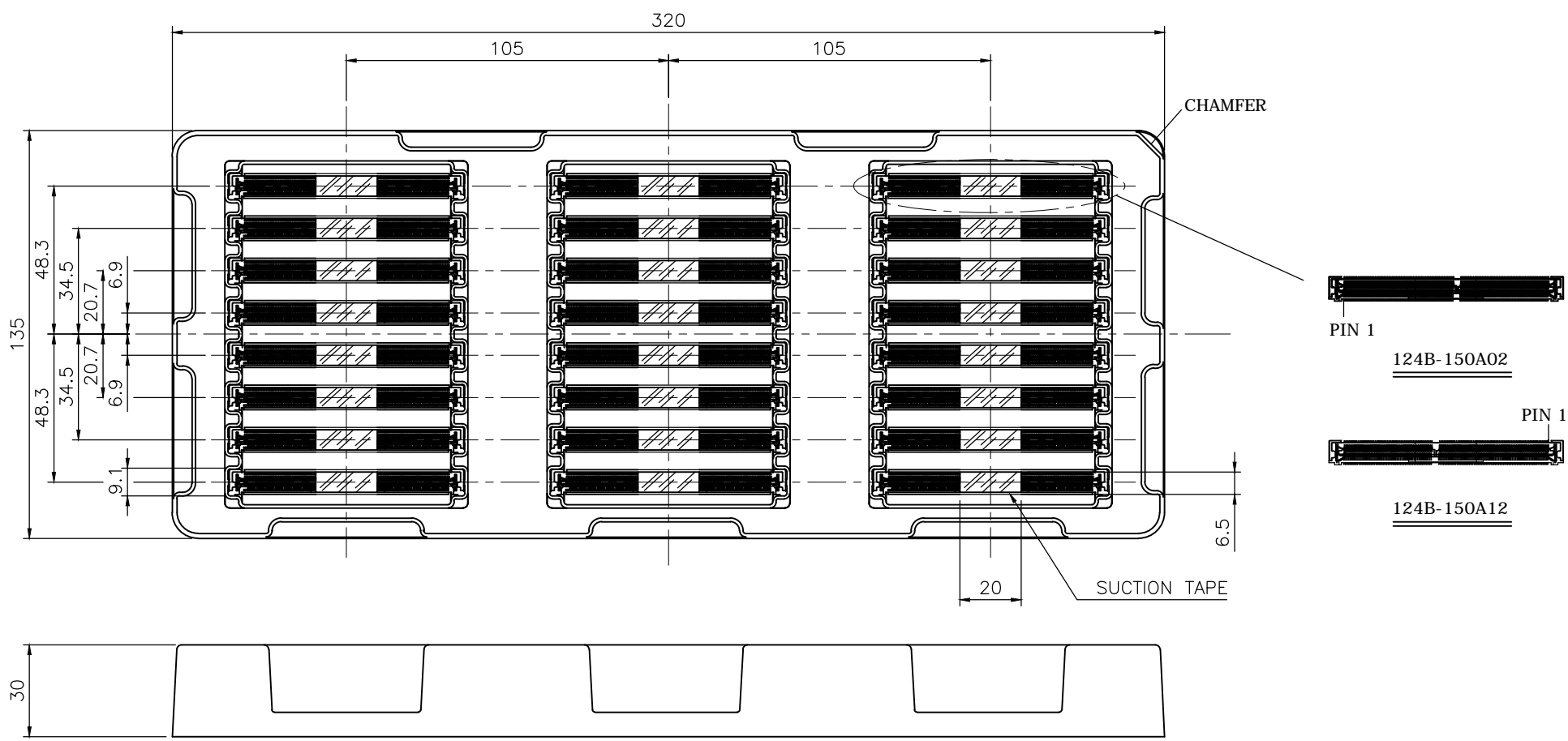
REV.	DESCRIPTION	DRAWN	DATE
1	Initial Release	TIM	2023/01/09



P/N	QTY/TRAY	INNER BOX	CARTON
124B-150A02	24	192	576
124B-150A12	24	192	576

UNLESS OTHERWISE SPECIFIED TOLERANCE				 WWW.ATTEND.COM.TW
UNIT:	DECIMAL	LINEAR	ANGLES	
mm	X.	±0.50	±5°	
	X.X	±0.25	±3°	
	X.XX	±0.12	±1°	
DRAWN	Tim	2022/10/11	DRAWN NAME:	
CHECKED	Fros	2022/10/11	DDR4 SODIMM Socket, Vertical PACKAGING	
APPROVED	Ken	2022/10/11	PRODUCT NO. SEE TABLE	
 SCALE 1/2	SHEET 1/1	SIZE A4	FILE NAME 124B-150AX2_D_1	