

REVISION RECORD				
REV	ECN	DESCRIPTION	DRFT	DATE

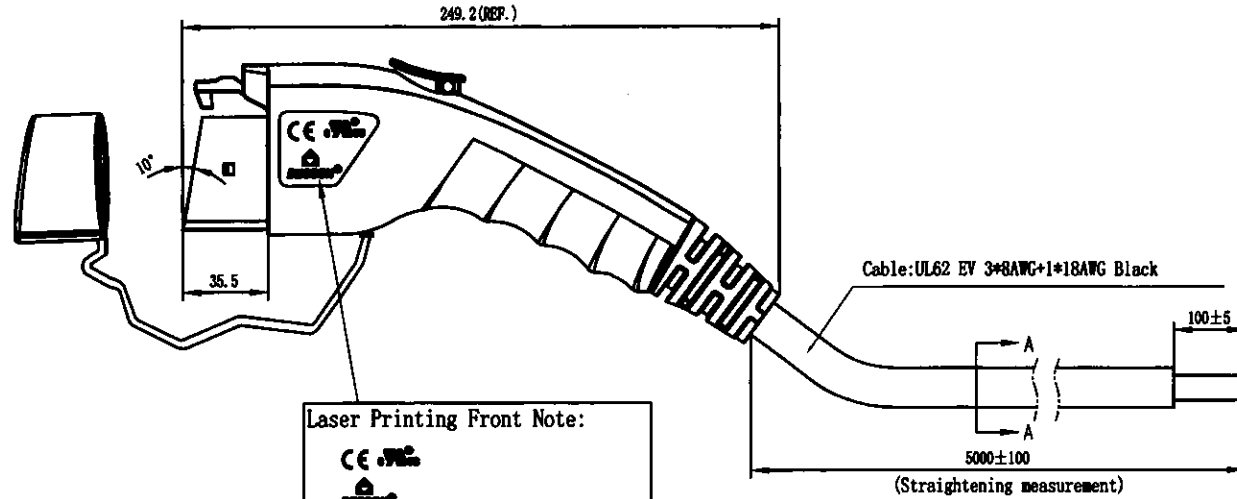

Wiring diagram

- L1 8AWG Brown
- N 8AWG Blue
- PE 8AWG Yellow/Green
- CS
- CP 18AWG Red

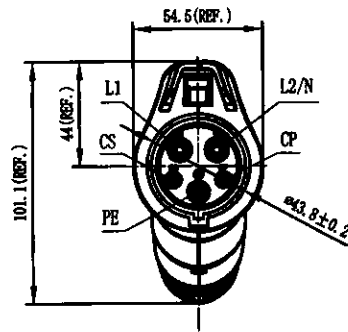
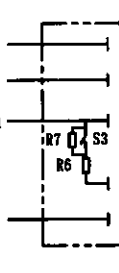

R6=150Ω±3%
R7=330Ω±3%

Laser Printing Front Note:

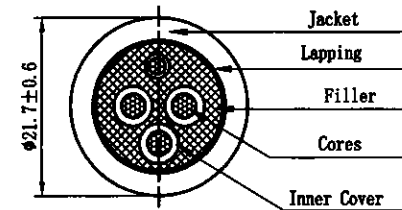
 Laser Printing Back Note (Arial):
 MAAC-S-040A-V-03-5. 0M-10AH
 40A 240V AC
 SAE J1772:2017
 Type 3S
 20XXXXXX-XXXX



SEC A-A

Technical parameters

Rated voltage	240V AC
Rated current	40A
Temperature range	-30℃~+50℃
Insulate resistance	>5MΩ, 500V DC
Withstanding voltage	L, N AND PE >2500V AC
	L AND N >2500V AC
Ingress protection	Type 3S
The insertion/pullout times	10000 TIMES
Insertion/pullout force	<75N
Reference standard	SAEJ1772:2017

Customer Drawing

Size Measure Range	.XX	.X
≤6	±0.05	±0.10
6~30	±0.10	±0.20
30~120	±0.15	±0.30
120~400	±0.20	±0.50
400~1000	±0.30	±0.80
1000~2000	±0.50	±1.20
Angle Measure Range	±0.5°	±1.0°

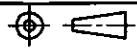
PART NO. : /	
APPD: ZX 21220413	
CHWD: DT 200.4.13	
DRFT: XP LUO 2019-06-13	
THIRD ANGLE PROJECTION	

 宁波高松电子有限公司 NINGBO DEGSON ELECTRICAL CO., LTD	
NAME: Vehicle Connector (40A AC single phase) MAAC-S-040A-V-03-5. 0M-10AH	
TITLE: Customer Drawing	REV DO-1
DRAWING NO. : /	SHEET 1/1
(INCH)	DO NOT SCALE DRAWING
SCALE	1:3