

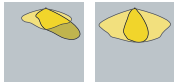

Datasheet

LL48NI-CTXxL46

Available Distribution



60°x155° 70°x150°

Dimensions

Part Number	LxW	Height
LL48NI-CTXxL46	230x60	6.64

*All dimensions are in millimeters.

LED



NICHIA
757GRT

Packaging Details (SPQ)

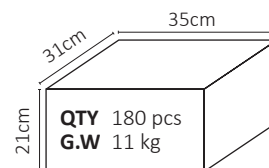

* If there is other requirements for packages, please revert back to us, especially for exporting foreign countries.

Recommad Applications



Street

General Information



- Lens Material PC 1225Z
- Operating Temperature -40°C~+110°C
- Light Transmission Rate 400nm~900nm > 90%
- ☑ If necessary, Clean lenses with mild soap, water and soft cloth.
- ⚠ Never use any commercial cleaning solvents on lenses, like alcohol.
- 🧤 Please handle or install lenses with wearing gloves, skin oils may damage lens or its optical characteristic.

Mechanical Specification

*All dimensions are in millimeters.

Lens Dimension

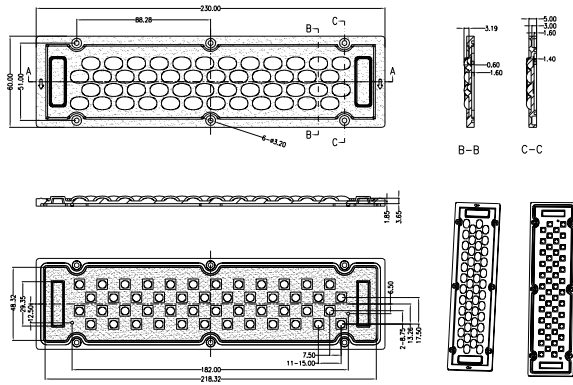

Assembly Instruction

Fixing Method

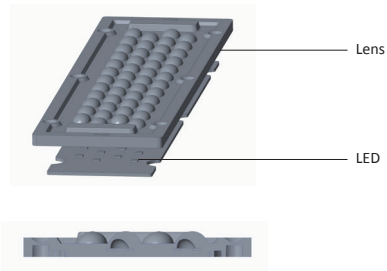

* After assembled with gasket, the distance is 0.2mm between light emitting hole and PCB.

Photometric Distribution



Distribution

60°×155°

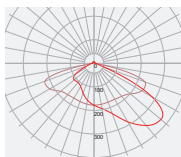

70°×150°

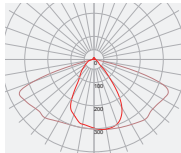

Details by LED

Part No	Accessories	LED Package Size	LED
LL48NI-CTXxxL46	-	3030	 NICHIA 757GRT

LED	Part No	Type	FWHM	cd / lm	IES
 NICHIA 757GRT	LL48NI-CTX60155L46	III-Medium	59°x153°	0.4	↓
	LL48NI-CTX70150L46	I-Short	69°x147°	0.4	↓

Product Nomenclature

Ledlink Led Type Lens Angle
LL 48 NI -CTX 60155 L46
Lens Dot Number Serial Number Type of Material

Ledlink Optics, Inc Taiwan HQ

15F, No.655, Bannan Rd., Chung-Ho Dist.,
New Taipei City, Taiwan 235

Ledlink Optics (Dongguan) Co., Ltd Dongguan Factory

No.5, TianKeng Industrial Dist., HengLiTown, DongGuan City,
GuangDong Province, China 523478

Ledlink Optics (Yangzhou) Co., Ltd Yangzhou Factory

No.180, LinJiang Rd., YangZhou City, Jiangsu Province, China 225009

www.ledlink-optics.com

service@ledlink-optics.com

