

MATERIAL:

HOUSING : PBT,UL94V-0,BLACK.
 TERMINALS BRACKET: PBT,UL94V-0,BLACK.
 SHIELD: C2680,T=0.20MM,NICKEL PLATING ON ALL AREA.
 TERMINAL: PHOSPHOR BRONZE C5210,T=0.35MM,
 6U" GOLD PLATING ON CONTACT AREA.

ORDER INFORMATION

5 R T 1 D R 1 0 R 2 N - 8 8 G A P X L - 111 - R 1

MECHANICAL:

DURABILITY : 750 CYCLES MIN.
 MATING FORCE : 23N MAX.
 OPERATING TEMPERATURE: -40°C~+85°C.
 STORAGE TEMPERATURE: -40°C~+85°C.

ELECTRICAL:

1. Turn Ratio: 1~2:J1~J2=1CT:1CT(±2%),
 3~6:J3~J6=1CT:1CT(±2%).
2. OCL: 350uH Min.at 100KHz 100mV 8mA DC.
3. Insertion Loss: -1.0 dB Max 1~100MHz.
4. Return loss: -18dB Min 1~30MHz;
 -14dB Min 30~60MHz;
 -10dB Min 60~100MHz.
5. Cross talk: -40dB Min 1~30MHz;
 -35dB Min 30~60MHz;
 -30dB Min 60~100MHz;
6. CMR: -35dB Min 1~100MHz;
7. Hi-Pot: 1500V AC & 2250V DC
 6S 1mA PRI TO SEC

LED Color Options Table		
Left(LED1)	Right(LED2)	No.
Yellow	Green	1
Yellow	Yellow	2
Green	Yellow	3
Green	Green	4

N:W/O Ear

GA:Gold 6u"

See LED Color Options Table

L:RoHS+PBT+Tray



AMTEK 耀德
 2018.09.25
 Released DCC

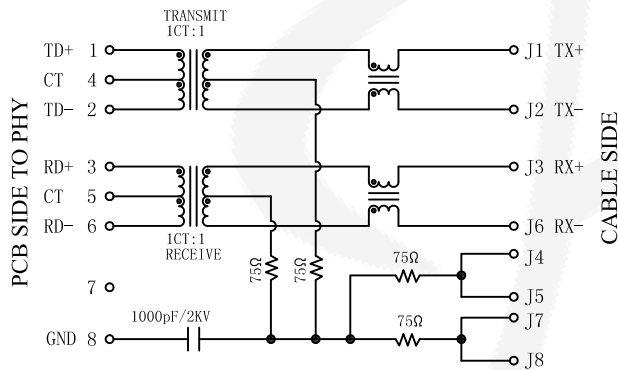

CABLE SIDE

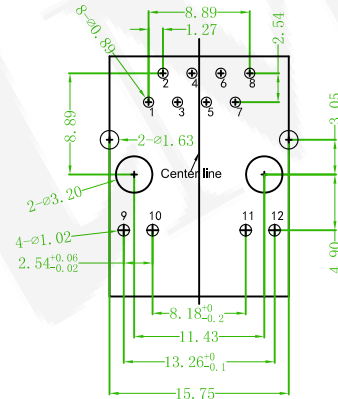

RECOMMENDED PCB LAYOUT

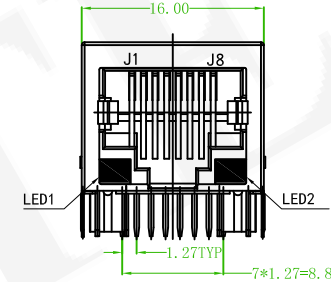
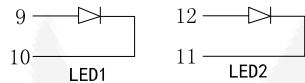

FRONT VIEW

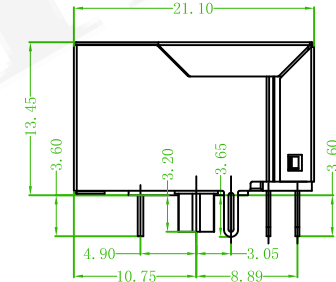

RIGHT SIDE VIEW

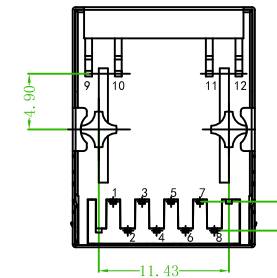

REV.	ECN NO. OR DESCRIPTION	REVISED	DATE

 耀德精密有限公司 Amtek Technology Co., Ltd. TEL: 886-2-2260-6878 FAX: 886-2-2260-8030	品名 TITLE	MODULAR JACK SIDE ENTRY				頁數 Page	1/1
	品號 PART NO.	5RT1DR10R2N-88GAPXL-111-R1				繪圖 DRAWN	Mia 2018/09/25
	圖號 DRAWING NO.	GN169-MD487		版本 REV.	A	核對 CHECKED	Josh 2018/09/25
	客戶品號 CUSTOMER P/N			比例 SCALE	None	承認 APPROVED	Jason 2018/09/25
	公差 TOLERANCE	.X ±0.30 .XX ±0.25		單位 UNIT	mm	THIRD ANGLE PROJECTION	