

修订 Revision						
记号 MARK	版本 REV.	修订内容 DESCRIPTION	变更单 ECN	日期 DATE	绘图 DWN.	核准 APVO.
	1.0	新版 NEW VERSION		DEC 09 2015		

NOTE:
1. AIRTIGHT CONNETOR SPECIFICATIONS CONFORM IPX7.
2. LOCATION OF CIRCUIT NUMBER.

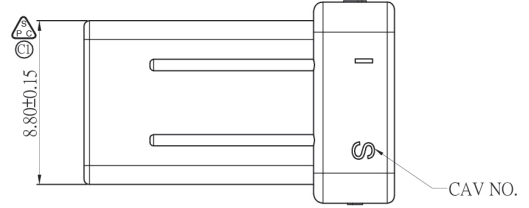
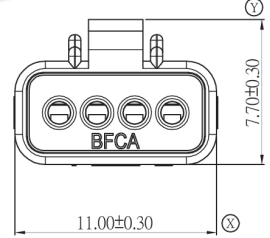
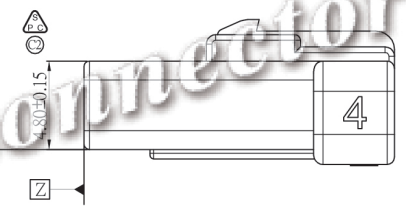
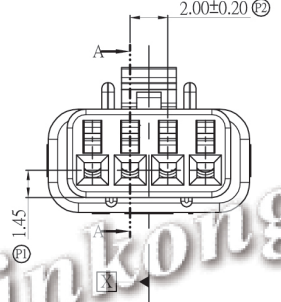
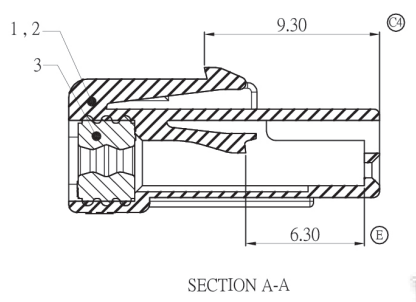
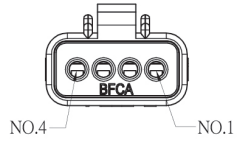
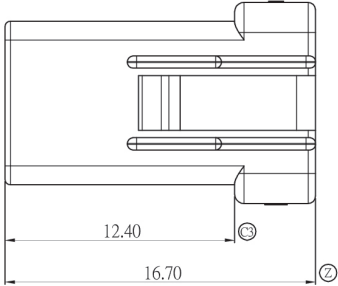
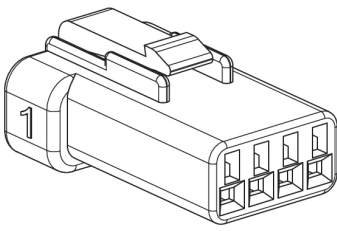

RoHS

SEAL	3	---	SILICONE	BLUE	---	---	材料 MATERIAL	SEE TABLE	AUTO CAD	一般公差 Tolerances unless other specified	乐清市千工电器有限公司 型号: CKK7041B-0.7-21 CKK7041D-0.7-21			
MASTER	2	---	PBT-GF	BLACK	---	---	表面处理 FINISH	SEE TABLE		<10.0 : ±0.20 >10.0 : ±0.30 >50.0 : ±0.55 >100.0 : ±0.95 >250.0 : ±1.40 ANGLE : ±30'				
F.P.	1	---	PBT-GF	WHITE	---	---	核发单位 ISSUED BY	制定单位 INSTITUTED BY	核准 APPROVED BY	审核 CONFIRMED BY		制定 DRAWN BY	绘图 DRAWER	
		CKK7041B-0.7-21	2+3	PBT-GF	BLACK	CKK7041B-0.7-11	CKK005-0.7FN							
		CKK7041D-0.7-21	1+3	PBT-GF	WHITE	CKK7041D-0.7-11								
类别 Type	NO.	产品编号 Part Number	构成零件 Composeparts	材质 Material	颜色 Color	对手件 Counter P/No.	配合端子 Applicable Ter.							
										图纸: size : A3	单位: Unit : mm	比例: Scale : 4:1	页数: Sheet : 1/1	CODE : S21