



LM2990 Negative Low-Dropout Regulator

1 Features

- Input Voltage: -26 V to -6 V
- Fixed Output Voltages: -5 V , -5.2 V , -12 V , and -15 V
- 5% Output Accuracy over Entire Operating Range
- Output Current in Excess of 1 A
- Dropout Voltage Typically 0.6 V at 1-A Load
- Low Quiescent Current
- Internal Short-Circuit Current Limit
- Internal Thermal Shutdown with Hysteresis
- Functional Complement to the LM2940 Series

2 Applications

- Post Switcher Regulator
- Local, On-Card Regulation
- Battery Operated Equipment

3 Description

The LM2990 is a three-terminal, low-dropout, 1-A negative voltage regulator available with fixed output voltages of -5 V , -5.2 V , -12 V , and -15 V .

The LM2990 uses circuit design techniques to provide low-dropout and low-quiescent current. The dropout voltage at 1-A load current is typically 0.6 V and an ensured worst-case maximum of 1 V over the entire operating temperature range. The quiescent current is typically 1 mA with 1-A load current and an input-output voltage differential greater than 3 V. A unique circuit design of the internal bias supply limits the quiescent current to only 9 mA (typical) when the regulator is in the dropout mode ($V_{\text{OUT}} - V_{\text{IN}} \leq 3\text{ V}$). Output voltage accuracy is ensured to $\pm 5\%$ over load and temperature extremes.

The LM2990 also implements short-circuit proof, and thermal shutdown includes hysteresis to enhance the reliability of the device when overloaded for an extended period of time.

All these features make the LM2990 an ideal negative power supply suited for dual supply systems. The device may also be used as fixed or adjustable current sink load.

The LM2990 is available in two 3-pin packages and is rated for operation over the junction temperature range of -40°C to 125°C .

Typical Application

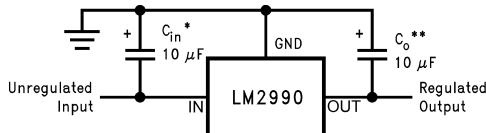

* and **: Required for stability. Must be at least a 10- μF aluminum electrolytic or a 1- μF solid tantalum to maintain stability. May be increased without bound to maintain regulation during transients. Locate the capacitor as close as possible to the regulator. The equivalent series resistance (ESR) is critical, and should be less than 10 Ω over the same operating temperature range as the regulator.

Device Information⁽¹⁾

PART NUMBER	PACKAGE	BODY SIZE (NOM)
LM2990	DDPAK/TO-263 (3)	10.20 mm x 9.00 mm
	TO-220 (3)	14.99 mm x 10.16 mm

(1) For all available packages, see the orderable addendum at the end of the datasheet.



Table of Contents

1 Features 1 2 Applications 1 3 Description 1 4 Revision History 2 5 Pin Configuration and Functions 3 6 Specifications 4 6.1 Absolute Maximum Ratings 4 6.2 ESD Ratings..... 4 6.3 Recommended Operating Conditions..... 4 6.4 Thermal Information 4 6.5 Electrical Characteristics: –5 V and –5.2 V..... 5 6.6 Electrical Characteristics: –12 V and –15 V..... 6 6.7 Typical Characteristics 6 7 Detailed Description 10 7.1 Overview 10 7.2 Functional Block Diagram 10	7.3 Feature Description..... 10 7.4 Device Functional Modes..... 11 8 Application and Implementation 12 8.1 Application Information..... 12 8.2 Typical Application 12 9 Power Supply Recommendations 14 10 Layout 15 10.1 Layout Guidelines 15 10.2 Layout Example 15 11 Device and Documentation Support 16 11.1 Device Support 16 11.2 Trademarks 16 11.3 Electrostatic Discharge Caution..... 16 11.4 Glossary 16 12 Mechanical, Packaging, and Orderable Information 16
---	---

4 Revision History

NOTE: Page numbers for previous revisions may differ from page numbers in the current version.

Changes from Revision F (February 2015) to Revision G	Page
<ul style="list-style-type: none"> • Changed "Ground" to "INPUT" in center of layout drawing 15 	15
Changes from Revision E (November 2014) to Revision F	Page
<ul style="list-style-type: none"> • Changed word "automotive" to "junction"; update pin names to TI nomenclature 1 • Changed <i>Handling Ratings</i> to <i>ESD Ratings</i> table; moved Storage temperature to Ab Max..... 4 • Changed wording of first sentence of <i>Low Dropout Voltage</i> section 10 • Changed wording of first sentence of <i>Application Information</i> section 12 • Added $I_{OUT} = 5\text{ mA}$ to "RMS noise" and "PSRR" rows..... 12 	12
Changes from Revision D (April 2013) to Revision E	Page
<ul style="list-style-type: none"> • Added <i>Device Information</i> and <i>Handling Rating</i> tables, <i>Feature Description</i>, <i>Device Functional Modes</i>, <i>Application and Implementation</i>, <i>Power Supply Recommendations</i>, <i>Layout</i>, <i>Device and Documentation Support</i>, and <i>Mechanical, Packaging, and Orderable Information</i> sections; moved some curves to <i>Application Curves</i> section; update new thermal values..... 1 	1

5 Pin Configuration and Functions

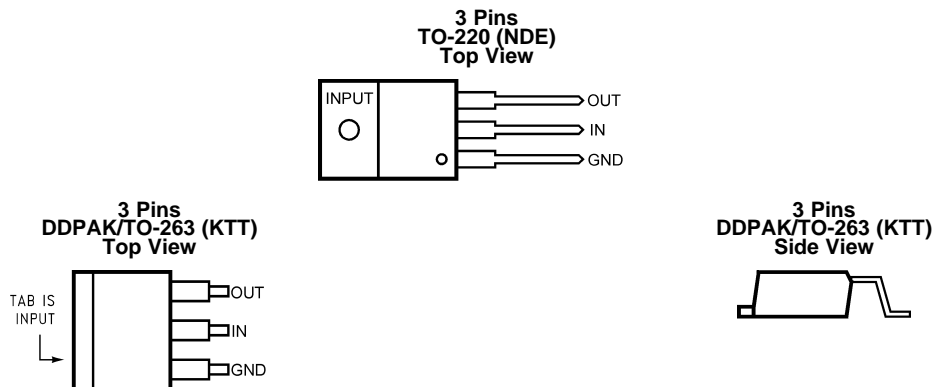

Pin Functions

PIN		I/O	DESCRIPTION
NAME	NO.		
GND	1	—	Ground.
IN	2	I	Input voltage.
OUT	3	O	Regulated output voltage.

6 Specifications

6.1 Absolute Maximum Ratings

over operating free-air temperature range (unless otherwise noted) ⁽¹⁾⁽²⁾

	MIN	MAX	UNIT
Input voltage	–26	0.3	V
Power dissipation ⁽³⁾	Internally limited		
Junction temperature (T_{Jmax})		125	°C
Storage temperature, T_{stg}	–65	150	°C

- (1) Stresses beyond those listed under *Absolute Maximum Ratings* may cause permanent damage to the device. These are stress ratings only, which do not imply functional operation of the device at these or any other conditions beyond those indicated under *Recommended Operating Conditions*. Exposure to absolute-maximum-rated conditions for extended periods may affect device reliability.
- (2) If Military/Aerospace specified devices are required, please contact the Texas Instruments Sales Office/Distributors for availability and specifications.
- (3) The maximum power dissipation is a function of T_{Jmax} , $R_{\theta JA}$, and T_A . The maximum allowable power dissipation at any ambient temperature is $PD = (T_{Jmax} - T_A)/R_{\theta JA}$. If this dissipation is exceeded, the die temperature will rise above 125°C, and the LM2990 will eventually go into thermal shutdown at a T_J of approximately 160°C. Please refer to [Thermal Information](#) for more details.

6.2 ESD Ratings

	VALUE	UNIT
$V_{(ESD)}$ Electrostatic discharge	Human-body model (HBM), per ANSI/ESDA/JEDEC JS-001 ⁽¹⁾	±2000 V

- (1) JEDEC document JEP155 states that 500-V HBM allows safe manufacturing with a standard ESD control process.

6.3 Recommended Operating Conditions

over operating free-air temperature range (unless otherwise noted)⁽¹⁾

	MIN	NOM	MAX	UNIT
Junction temperature (T_J)	–40		125	°C
Input voltage (operational)	–26		–6	V

- (1) Stresses beyond those listed under *Absolute Maximum Ratings* may cause permanent damage to the device. These are stress ratings only, which do not imply functional operation of the device at these or any other conditions beyond those indicated under *Recommended Operating Conditions*. Exposure to absolute-maximum-rated conditions for extended periods may affect device reliability.

6.4 Thermal Information

THERMAL METRIC ⁽¹⁾		LM2990S	LM2990T	UNIT
		TO-263 (KTT)	TO-220 (NDE)	
		3 PINS	3 PINS	
$R_{\theta JA}$	Junction-to-ambient thermal resistance, High-K	41.3	22.8	°C/W
$R_{\theta JC(top)}$	Junction-to-case (top) thermal resistance	43	15.7	
$R_{\theta JB}$	Junction-to-board thermal resistance	23.2	4.2	
Ψ_{JT}	Junction-to-top characterization parameter	11.3	2.2	
Ψ_{JB}	Junction-to-board characterization parameter	20.4	4.2	
$R_{\theta JC(bot)}$	Junction-to-case (bottom) thermal resistance	0.5	0.7	

- (1) For more information about traditional and new thermal metrics, see the *IC Package Thermal Metrics* application report, [SPRA953](#).

6.5 Electrical Characteristics: –5 V and –5.2 V

$V_{IN} = -5\text{ V} + V_{OUT(NOM)}$ ⁽¹⁾, $I_{OUT} = 1\text{ A}$, $C_{OUT} = 47\text{ }\mu\text{F}$, unless otherwise specified. All limits apply for $T_J = 25^\circ\text{C}$, unless otherwise indicated in the Test Conditions.

PARAMETER	TEST CONDITIONS	LM2990 –5V			LM2990 –5.2V			UNIT
		MIN ⁽²⁾	TYP ⁽³⁾	MAX ⁽²⁾	MIN ⁽²⁾	TYP ⁽³⁾	MAX ⁽²⁾	
Output voltage (V_{OUT})	$5\text{ mA} \leq I_{OUT} \leq 1\text{ A}$	-5.1	-5	-4.9	-5.3	-5.2	-5.1	V
	$5\text{ mA} \leq I_{OUT} \leq 1\text{ A}$ $-40^\circ\text{C} \leq T_J \leq 125^\circ\text{C}$	-5.25	-5	-4.75	-5.46	-5.2	-4.94	V
Line regulation	$I_{OUT} = 5\text{ mA}$, $V_{O(NOM)} - 1\text{ V} > V_{IN} > -26\text{ V}$		4	40		4	40	mV
Load regulation	$50\text{ mA} \leq I_{OUT} \leq 1\text{ A}$		1	40		1	40	mV
Dropout voltage	$I_{OUT} = 0.1\text{ A}$, $\Delta V_{OUT} \leq 100\text{ mV}$ $-40^\circ\text{C} \leq T_J \leq 125^\circ\text{C}$		0.1	0.3		0.1	0.3	V
	$I_{OUT} = 1\text{ A}$, $\Delta V_{OUT} \leq 100\text{ mV}$ $-40^\circ\text{C} \leq T_J \leq 125^\circ\text{C}$		0.6	1		0.6	1	V
Quiescent current (I_q)	$I_{OUT} \leq 1\text{ A}$		1	5		1	5	mA
	$I_{OUT} = 1\text{ A}$, $V_{IN} = V_{OUT(NOM)}$		9	50		9	50	
Short circuit current	$R_L = 1\text{ }\Omega$ ⁽⁴⁾	1.5	1.8		1.5	1.8		A
Maximum output current	See ⁽⁴⁾	1.5	1.8		1.5	1.8		A
Ripple rejection	$V_{ripple} = 1\text{ V}_{rms}$, $f_{ripple} = 1\text{ kHz}$, $I_{OUT} = 5\text{ mA}$	50	58		50	58		dB _(min)
Output noise voltage	10 Hz to 100 kHz, $I_{OUT} = 5\text{ mA}$		250	750		250	750	$\mu\text{V}_{(max)}$
Long-term stability	1000 Hours		2000			2000		ppm

(1) $V_{OUT(NOM)}$ is the nominal (typical) regulator output voltage, –5 V, –5.2 V, –12 V or –15 V.

(2) Limits are specified and 100% production tested.

(3) Typicals are at $T_J = 25^\circ\text{C}$ and represent the most likely parametric norm.

(4) The short circuit current is less than the maximum output current with the –12 V and –15 V versions due to internal foldback current limiting. The –5 V and –5.2 V versions, tested with a lower input voltage, does not reach the foldback current limit and therefore conducts a higher short circuit current level. If the LM2990 output is pulled above ground, the maximum allowed current sunk back into the LM2990 is 1.5 A.

6.6 Electrical Characteristics: –12 V and –15 V

$V_{IN} = -5\text{ V} + V_{OUT(NOM)}^{(1)}$, $I_{OUT} = 1\text{ A}$, $C_{OUT} = 47\text{ }\mu\text{F}$, unless otherwise specified. All limits apply for $T_J = 25^\circ\text{C}$, unless otherwise indicated in the Test Conditions.

PARAMETER	TEST CONDITIONS	LM2990 –12V			LM2990 –15V			UNIT
		MIN ⁽²⁾	TYP ⁽³⁾	MAX ⁽²⁾	MIN ⁽²⁾	TYP ⁽³⁾	MAX ⁽²⁾	
Output voltage (V_{OUT})	$5\text{ mA} \leq I_{OUT} \leq 1\text{ A}$	-12.24	-12	-11.76	-15.30	-15	-14.70	V
	$5\text{ mA} \leq I_{OUT} \leq 1\text{ A}$ $-40^\circ\text{C} \leq T_J \leq 125^\circ\text{C}$	-12.60	-12	-11.40	-15.75	-15	-14.25	V
Line regulation	$I_{OUT} = 5\text{ mA}$, $V_{OUT(NOM)} - 1\text{ V} > V_{IN} > -26\text{ V}$		6	60		6	60	mV
Load regulation	$50\text{ mA} \leq I_{OUT} \leq 1\text{ A}$		3	50		3	50	mV
Dropout voltage	$I_{OUT} = 0.1\text{ A}$, $\Delta V_{OUT} \leq 100\text{ mV}$ $-40^\circ\text{C} \leq T_J \leq 125^\circ\text{C}$		0.1	0.3		0.1	0.3	V
	$I_{OUT} = 1\text{ A}$, $\Delta V_{OUT} \leq 100\text{ mV}$ $-40^\circ\text{C} \leq T_J \leq 125^\circ\text{C}$		0.6	1		0.6	1	V
Quiescent current (I_q)	$I_{OUT} \leq 1\text{ A}$		1	5		1	5	mA
	$I_{OUT} = 1\text{ A}$, $V_{IN} = V_{OUT(NOM)}$		9	50		9	50	
Short circuit current	$R_L = 1\text{ }\Omega^{(4)}$	0.9	1.2		0.75	1.2		A
Maximum output current	See ⁽⁴⁾	1.4	1.8		1.4	1.8		A
Ripple rejection	$V_{ripple} = 1\text{ V}_{rms}$, $f_{ripple} = 1\text{ kHz}$, $I_{OUT} = 5\text{ mA}$	42	52		42	52		dB _(min)
Output noise voltage	10 Hz to 100 kHz, $I_{OUT} = 5\text{ mA}$		500	1500		500	1500	$\mu\text{V}_{(max)}$
Long-term stability	1000 hours		2000			2000		ppm

(1) $V_{OUT(NOM)}$ is the nominal (typical) regulator output voltage, –5 V, –5.2 V, –12 V or –15 V.

(2) Limits are specified and 100% production tested.

(3) Typicals are at $T_J = 25^\circ\text{C}$ and represent the most likely parametric norm.

(4) The short circuit current is less than the maximum output current with the –12 V and –15 V versions due to internal foldback current limiting. The –5 V and –5.2 V versions, tested with a lower input voltage, does not reach the foldback current limit and therefore conducts a higher short circuit current level. If the LM2990 output is pulled above ground, the maximum allowed current sunk back into the LM2990 is 1.5 A.

6.7 Typical Characteristics

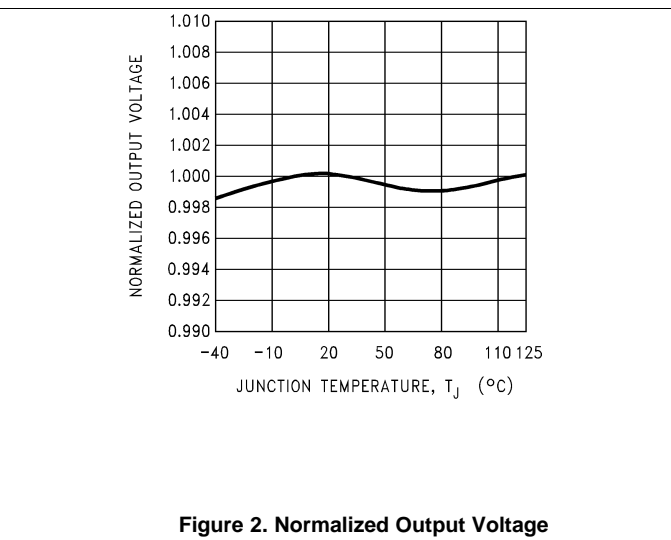
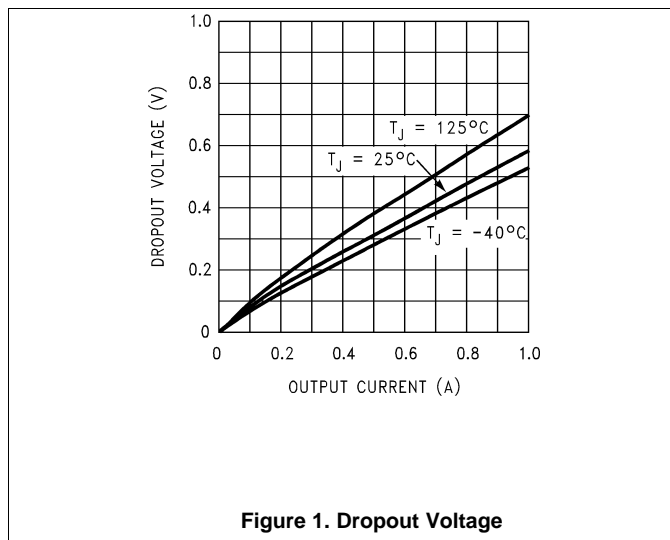

Typical Characteristics (continued)

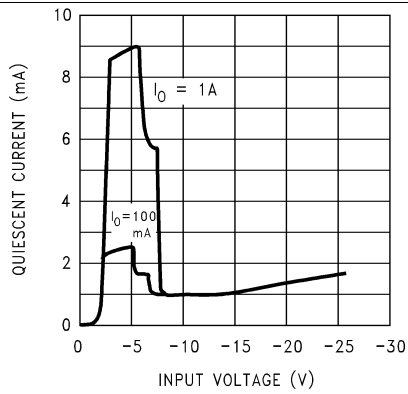

Figure 3. LM2990-5.0 and LM2990-5.2 Quiescent Current

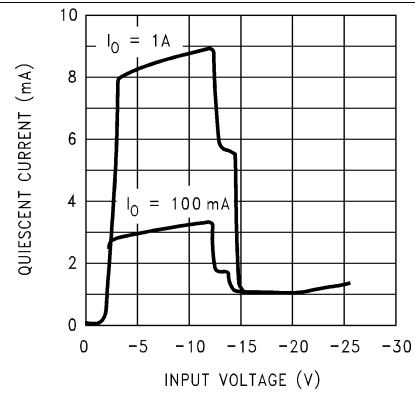

Figure 4. LM2990-12 Quiescent Current

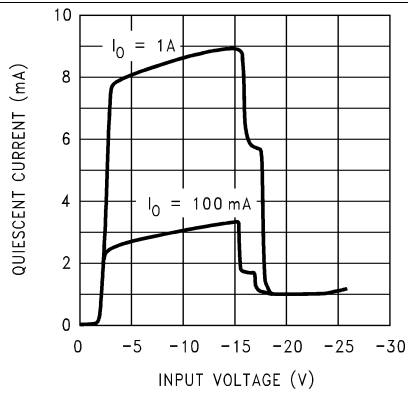

Figure 5. LM2990-15 Quiescent Current

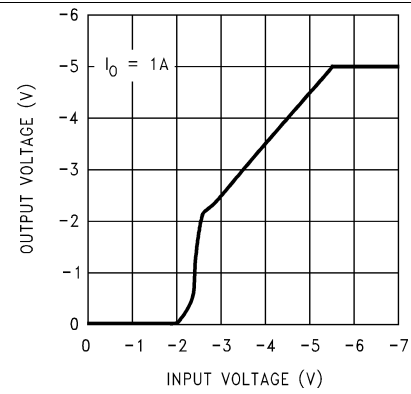

Figure 6. LM2990-5 and LM2990-5.2 Low Voltage Behavior

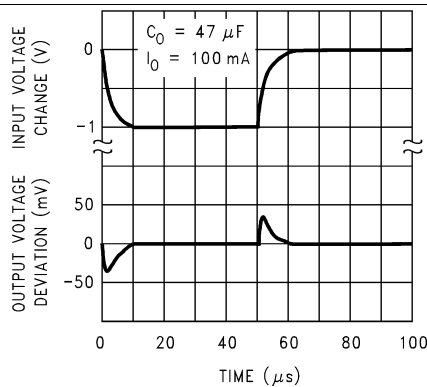

Figure 7. LM2990-5 and LM2990-5.2 Line Transient Response

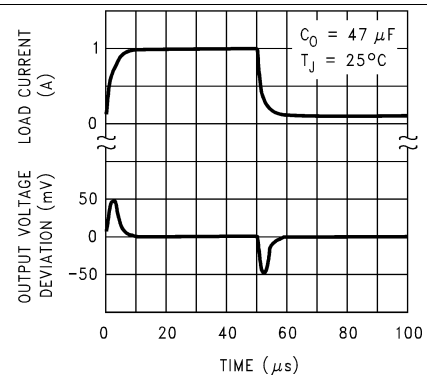

Figure 8. LM2990-5 and LM2990-5.2 Load Transient Response

Typical Characteristics (continued)

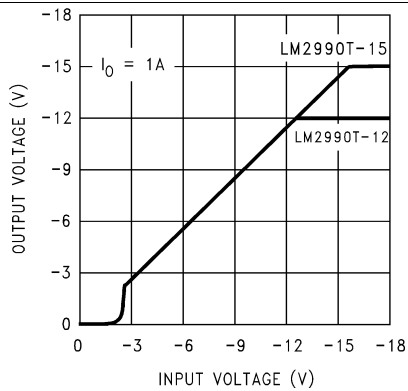

Figure 9. LM2990-12 and LM2990-15 Low-Voltage Behavior

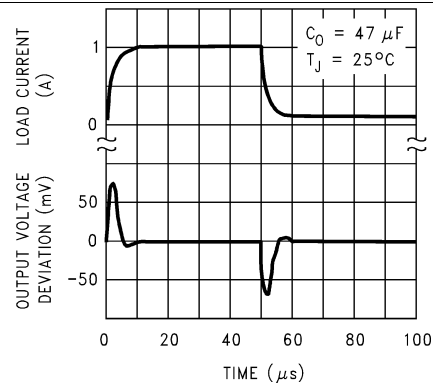

Figure 10. LM2990-12 and LM2990-15 Line Transient Response

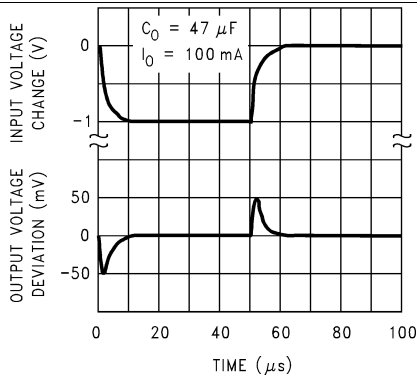

Figure 11. LM2990-12 and LM2990-15 Load Transient Response

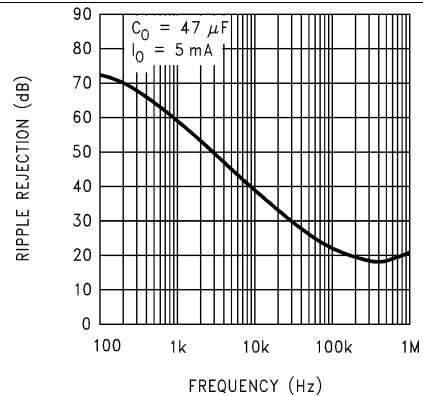

Figure 12. LM2990-5 and LM2990-5.2 Ripple Rejection

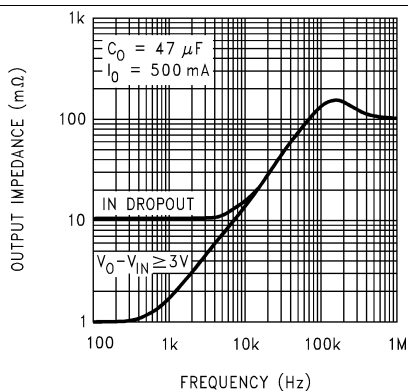

Figure 13. LM2990-5 and LM2990-5.2 Output Impedance

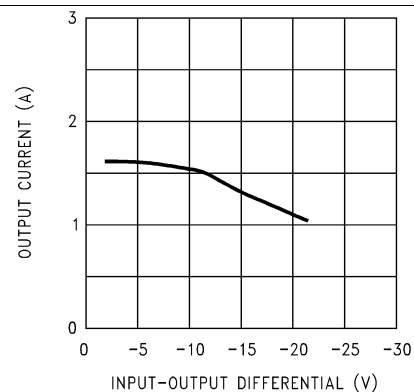

Figure 14. Maximum Output Current

Typical Characteristics (continued)

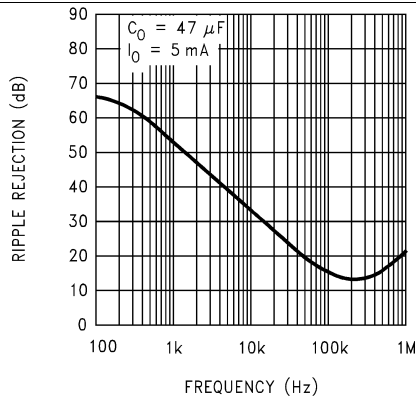

Figure 15. LM2990-12 and LM2990-15 Ripple Rejection

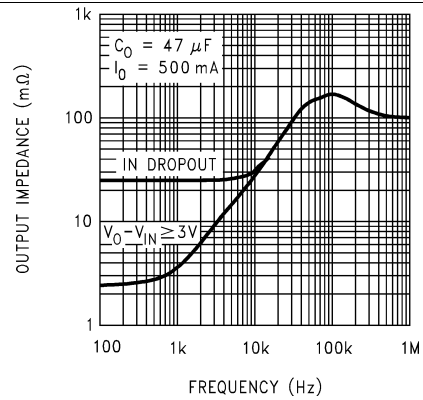

Figure 16. LM2990-12 and LM2990-15 Output Impedance

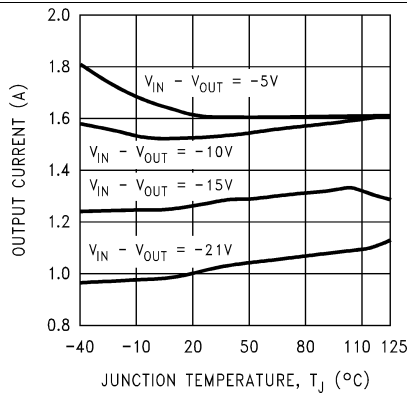

Figure 17. Maximum Output Current

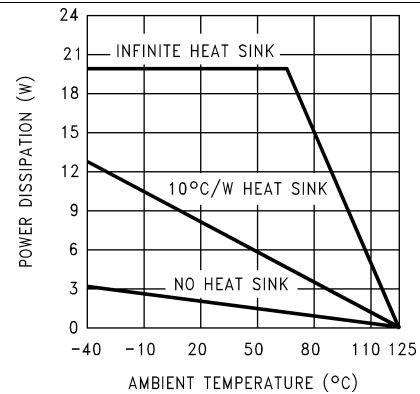
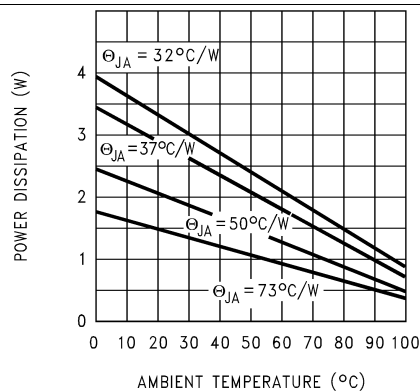

Figure 18. Maximum Power Dissipation (TO-220)



The maximum power dissipation is a function of T_{Jmax} , $R_{\theta JA}$, and T_A . The maximum allowable power dissipation at any ambient temperature is $P_D = (T_{Jmax} - T_A)/R_{\theta JA}$. If this dissipation is exceeded, the die temperature will rise above 125°C, and the LM2990 will eventually go into thermal shutdown at a T_J of approximately 160°C. Please refer to [Thermal Information](#) for more details.

Figure 19. Maximum Power Dissipation (TO-263)

7 Detailed Description

7.1 Overview

The LM2990 is a three-terminal, low dropout, 1-A negative voltage regulator available with fixed output voltages of -5 , -5.2 , -12 , and -15 V. The LM2990 is a negative power supply ideally suited for a dual-supply system when using together with LM2940 series. The device may also be used as a fixed or adjustable current sink load.

7.2 Functional Block Diagram

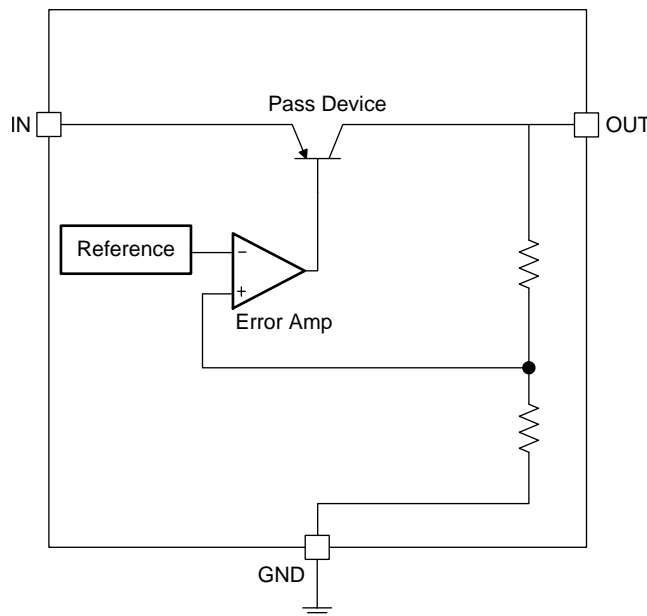

7.3 Feature Description

7.3.1 Fixed Output-Voltage Options

The LM2990 provides 4 fixed output options: -5 V, -5.2 V, -12 V, and -15 V. Output voltage accuracy is ensured to $\pm 5\%$ over load and temperature extremes.

7.3.2 Low Dropout Voltage

Generally speaking, the dropout voltage (V_{DO}) refers to the voltage difference between the IN pin and the OUT pin when the PNP pass element is fully on and is characterized by the classic Collector-to-Emitter saturation voltage, $V_{CE(SAT)}$. V_{DO} indirectly specifies a minimum input voltage above the nominal programmed output voltage at which the output voltage is expected to remain within its accuracy boundary.

7.3.3 Short Circuit Protection (Current Limit)

The internal current limit circuit is used to protect the LDO against high-load current faults or shorting events. The LDO is not designed to operate in a steady-state current limit. During a current-limit event, the LDO sources constant current. Therefore, the output voltage falls when load impedance decreases. Note also that if a current limit occurs and the resulting output voltage is low, excessive power may be dissipated across the LDO, resulting in a thermal shutdown of the output. A fold back feature limits the short-circuit current to protect the regulator from damage under all load conditions. If OUT is forced below 0 V before EN goes high, and the load current required exceeds the fold back current limit, the device may not start up correctly.

Feature Description (continued)

7.3.4 Thermal Protection

The device contains a thermal shutdown protection circuit to turn off the output current when excessive heat is dissipated in the LDO. The thermal time-constant of the semiconductor die is fairly short, and thus the output cycles on and off at a high rate when thermal shutdown is reached until the power dissipation is reduced. The internal protection circuitry of the device is designed to protect against thermal overload conditions. The circuitry is not intended to replace proper heat sinking. Continuously running the device into thermal shutdown degrades its reliability.

7.4 Device Functional Modes

7.4.1 Operation with $V_{OUT(TARGET)} - 5\text{ V} \geq V_{IN} > -26\text{ V}$

The device operates if the input voltage is within $V_{OUT(TARGET)} - 5\text{ V}$ to -26 V range. At input voltages beyond the V_{IN} requirement, the devices do not operate correctly, and output voltage may not reach target value.

8 Application and Implementation

NOTE

Information in the following applications sections is not part of the TI component specification, and TI does not warrant its accuracy or completeness. TI's customers are responsible for determining suitability of components for their purposes. Customers should validate and test their design implementation to confirm system functionality.

8.1 Application Information

The LM2990 is a 1-A negative voltage regulator with an operating V_{IN} range of -6 V to -26 V , and a regulated V_{OUT} having 5% accuracy with a maximum rated I_{OUT} current of 1 A. Efficiency is defined by the ratio of output voltage to input voltage because the LM2990 is a linear voltage regulator. To achieve high efficiency, the dropout voltage ($V_{IN} - V_{OUT}$) must be as small as possible, thus requiring a very low dropout LDO.

Successfully implementing an LDO in an application depends on the application requirements. If the requirements are simply input voltage and output voltage, compliance specifications (such as internal power dissipation or stability) must be verified to ensure a solid design. If timing, start-up, noise, PSRR, or any other transient specification is required, the design becomes more challenging.

8.2 Typical Application

8.2.1 -5 V Post Regulator for an Isolated Switching Power Supply

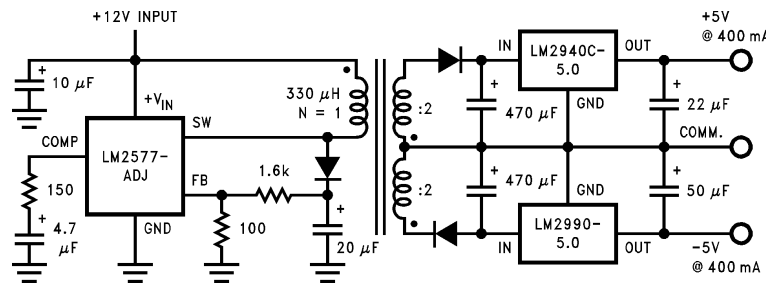

Figure 20. Post Regulator for an Isolated Switching Power Supply

8.2.1.1 Design Requirements

For this design example, use the parameters listed in Table 1 as the input parameters.

Table 1. Design Parameters

DESIGN PARAMETER	DESIGN REQUIREMENT
Input voltage	-10 V , provided by the DC-DC converter switching at 1 MHz
Output voltage	-5 V , $\pm 10\%$
Output current	5 mA to 400 mA
RMS noise, 10 Hz to 100 kHz	$< 1\text{ mV}_{\text{RMS}}$, $I_{\text{OUT}} = 5\text{ mA}$
PSRR at 1KHz	$> 45\text{ dB}$, $I_{\text{OUT}} = 5\text{ mA}$

8.2.1.2 Detailed Design Procedure

At 400-mA loading, the dropout of the LM2990 has 1-V maximum dropout over temperature, thus an -5 V headroom is sufficient for operation over both input and output voltage accuracy. The efficiency of the LM2990 in this configuration is $V_{\text{OUT}} / V_{\text{IN}} = 50\%$.

To achieve the smallest form factor, the TO-263(KTT) package is selected. Input and output capacitors should be selected in accordance with the [External Capacitors](#) section. Aluminum capacitances of 470 μF for the input and 50- μF capacitors for the output are selected. With an efficiency of 50% and a 400-mA maximum load, the internal power dissipation is 2000 mW, which corresponds to 82.5°C junction temperature rise for the TO-263 package. With a 25°C ambient temperature, the junction temperature is at 107.5°C.

8.2.1.2.1 External Capacitors

The LM2990 regulator requires an output capacitor to maintain stability. The capacitor must be at least 10- μ F aluminum electrolytic or 1- μ F solid tantalum. The equivalent series resistance (ESR) of the output capacitor must be less than 10 Ω , or the zero added to the regulator frequency response by the ESR could reduce the phase margin, creating oscillations. An input capacitor, of at least 1- μ F solid tantalum or 10- μ F aluminum electrolytic, is also needed if the regulator is situated more than 6 from the input power supply filter.

8.2.1.2.2 Forcing The Output Positive

Due to an internal clamp circuit, the LM2990 can withstand positive voltages on its output. If the voltage source pulling the output positive is DC, the current must be limited to 1.5 A. A current over 1.5 A fed back into the LM2990 could damage the device. The LM2990 output can also withstand fast positive voltage transients up to 26V, without any current limiting of the source. However, if the transients have a duration of over 1 ms, the output should be clamped with a Schottky diode to ground.

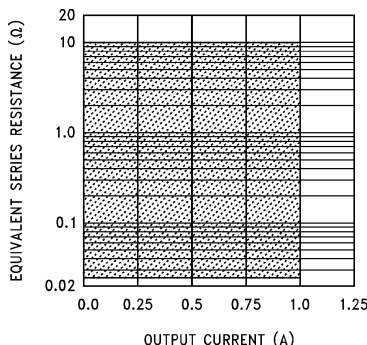

Figure 21. Output Capacitor ESR

8.2.1.3 Application Curves

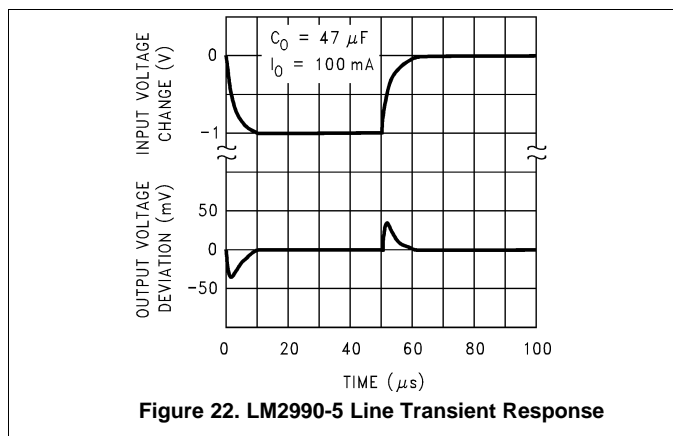

Figure 22. LM2990-5 Line Transient Response

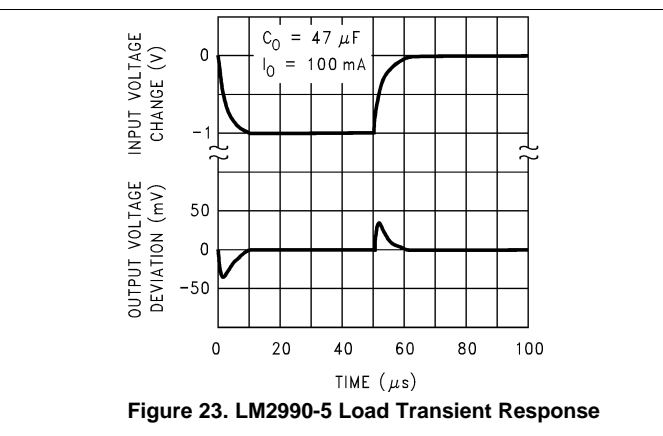

Figure 23. LM2990-5 Load Transient Response

8.2.2 Fixed or Adjustable Current Sink

The LM2990 is configurable as a fixed or adjustable current sink. As Figure 24 and Figure 25 show, the sink current is determined by the resistor value — to achieve adjustable sink current, add one adjustable resistor between output and load.

LM2990

SNVS093G – JUNE 1999 – REVISED MAY 2015

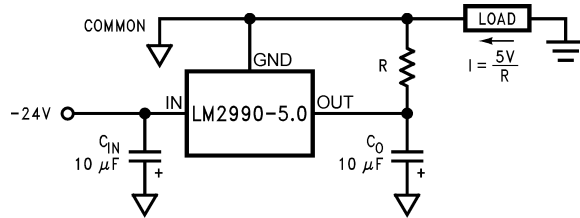
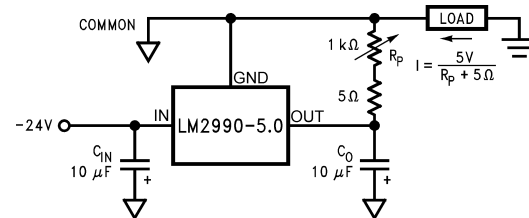
www.ti.com

Figure 24. Fixed Current Sink

Figure 25. Adjustable Current Sink
8.2.2.1 Design Requirements

 See [Design Requirements](#).

8.2.2.2 Detailed Design Procedure

 See [Detailed Design Procedure](#).

8.2.2.3 Application Curves

 See [Application Curves](#).

9 Power Supply Recommendations

The LM2990 is designed to operate from an input voltage supply range between -6 V and -26 V . The input voltage range should provide adequate headroom in order for the device to have a regulated output. This input supply must be well regulated.

10 Layout

10.1 Layout Guidelines

For best overall performance, place all circuit components on the same side of the circuit board and as near as practical to the respective LDO pin connections. Place ground return connections to the input and output capacitor, and to the LDO ground pin as close to each other as possible, connected by a wide, component-side, copper surface. The use of vias and long traces to create LDO circuit connections is strongly discouraged and negatively affects system performance. This grounding and layout scheme minimizes inductive parasitics, and thereby reduces load-current transients, minimizes noise, and increases circuit stability. A ground reference plane is also recommended and is either embedded in the PCB itself or located on the bottom side of the PCB opposite the components. This reference plane serves to assure accuracy of the output voltage, shield noise, and behaves similar to a thermal plane to spread (or sink) heat from the LDO device. In most applications, this ground plane is necessary to meet thermal requirements.

10.2 Layout Example

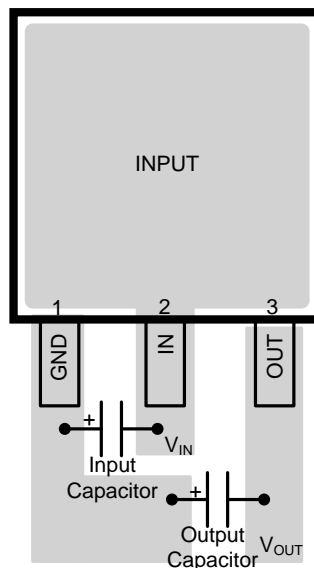

Figure 26. LM2990 TO-263 Board Layout

11 Device and Documentation Support

11.1 Device Support

11.1.1 Device Nomenclature

Dropout Voltage: The input-output voltage differential at which the circuit ceases to regulate against further reduction in input voltage. Measured when the output voltage has dropped 100 mV from the nominal value obtained at ($V_{OUT} + 5$ V) input, dropout voltage is dependent upon load current and junction temperature.

Input Voltage: The DC voltage applied to the input terminals with respect to ground.

Input-Output Differential: The voltage difference between the unregulated input voltage and the regulated output voltage for which the regulator will operate.

Line Regulation: The change in output voltage for a change in the input voltage. The measurement is made under conditions of low dissipation or by using pulse techniques such that the average chip temperature is not significantly affected.

Load Regulation: The change in output voltage for a change in load current at constant chip temperature.

Long Term Stability: Output voltage stability under accelerated life-test conditions after 1000 hours with maximum rated voltage and junction temperature.

Output Noise Voltage: The rms AC voltage at the output, with constant load and no input ripple, measured over a specified frequency range.

Quiescent Current: That part of the positive input current that does not contribute to the positive load current. The regulator ground lead current.

Ripple Rejection: The ratio of the peak-to-peak input ripple voltage to the peak-to-peak output ripple voltage.

Temperature Stability of V_{OUT} : The percentage change in output voltage for a thermal variation from room temperature to either temperature extreme.

11.2 Trademarks

All trademarks are the property of their respective owners.

11.3 Electrostatic Discharge Caution



These devices have limited built-in ESD protection. The leads should be shorted together or the device placed in conductive foam during storage or handling to prevent electrostatic damage to the MOS gates.

11.4 Glossary

[SLYZ022](#) — *TI Glossary*.

This glossary lists and explains terms, acronyms, and definitions.

12 Mechanical, Packaging, and Orderable Information

The following pages include mechanical, packaging, and orderable information. This information is the most current data available for the designated devices. This data is subject to change without notice and revision of this document. For browser-based versions of this data sheet, refer to the left-hand navigation.

PACKAGING INFORMATION

Orderable Device	Status (1)	Package Type	Package Drawing	Pins	Package Qty	Eco Plan (2)	Lead finish/ Ball material (6)	MSL Peak Temp (3)	Op Temp (°C)	Device Marking (4/5)	Samples
LM2990S-12	LIFEBUY	DDPAK/ TO-263	KTT	3	45	Non-RoHS & Green	Call TI	Level-3-235C-168 HR	-40 to 125	LM2990S -12 P+	
LM2990S-12/NOPB	ACTIVE	DDPAK/ TO-263	KTT	3	45	RoHS-Exempt & Green	SN	Level-3-245C-168 HR	-40 to 125	LM2990S -12 P+	Samples
LM2990S-15	LIFEBUY	DDPAK/ TO-263	KTT	3	45	Non-RoHS & Green	Call TI	Level-3-235C-168 HR	-40 to 125	LM2990S -15 P+	
LM2990S-15/NOPB	ACTIVE	DDPAK/ TO-263	KTT	3	45	RoHS-Exempt & Green	SN	Level-3-245C-168 HR	-40 to 125	LM2990S -15 P+	Samples
LM2990S-5.0	LIFEBUY	DDPAK/ TO-263	KTT	3	45	Non-RoHS & Green	Call TI	Level-3-235C-168 HR	-40 to 125	LM2990S -5.0 P+	
LM2990S-5.0/NOPB	ACTIVE	DDPAK/ TO-263	KTT	3	45	RoHS-Exempt & Green	SN	Level-3-245C-168 HR	-40 to 125	LM2990S -5.0 P+	Samples
LM2990SX-12	LIFEBUY	DDPAK/ TO-263	KTT	3	500	Non-RoHS & Green	Call TI	Level-3-235C-168 HR	-40 to 125	LM2990S -12 P+	
LM2990SX-12/NOPB	ACTIVE	DDPAK/ TO-263	KTT	3	500	RoHS-Exempt & Green	SN	Level-3-245C-168 HR	-40 to 125	LM2990S -12 P+	Samples
LM2990SX-15	LIFEBUY	DDPAK/ TO-263	KTT	3	500	Non-RoHS & Green	Call TI	Level-3-235C-168 HR	-40 to 125	LM2990S -15 P+	
LM2990SX-15/NOPB	ACTIVE	DDPAK/ TO-263	KTT	3	500	RoHS-Exempt & Green	SN	Level-3-245C-168 HR	-40 to 125	LM2990S -15 P+	Samples
LM2990SX-5.0	LIFEBUY	DDPAK/ TO-263	KTT	3	500	Non-RoHS & Green	Call TI	Level-3-235C-168 HR	-40 to 125	LM2990S -5.0 P+	
LM2990SX-5.0/NOPB	ACTIVE	DDPAK/ TO-263	KTT	3	500	RoHS-Exempt & Green	SN	Level-3-245C-168 HR	-40 to 125	LM2990S -5.0 P+	Samples
LM2990T-12	LIFEBUY	TO-220	NDE	3	45	Non-RoHS & Green	Call TI	Level-1-NA-UNLIM	-40 to 125	LM2990T -12 P+	
LM2990T-12/NOPB	ACTIVE	TO-220	NDE	3	45	RoHS & Green	SN	Level-1-NA-UNLIM	-40 to 125	LM2990T -12 P+	Samples
LM2990T-15	LIFEBUY	TO-220	NDE	3	45	Non-RoHS & Green	Call TI	Level-1-NA-UNLIM	-40 to 125	LM2990T -15 P+	
LM2990T-15/NOPB	ACTIVE	TO-220	NDE	3	45	RoHS & Green	SN	Level-1-NA-UNLIM	-40 to 125	LM2990T -15 P+	Samples

Orderable Device	Status (1)	Package Type	Package Drawing	Pins	Package Qty	Eco Plan (2)	Lead finish/ Ball material (6)	MSL Peak Temp (3)	Op Temp (°C)	Device Marking (4/5)	Samples
LM2990T-5.0	LIFEBUY	TO-220	NDE	3	45	Non-RoHS & Green	Call TI	Level-1-NA-UNLIM	-40 to 125	LM2990T -5.0 P+	
LM2990T-5.0/NOPB	ACTIVE	TO-220	NDE	3	45	RoHS-Exempt & Green	SN	Level-1-NA-UNLIM	-40 to 125	LM2990T -5.0 P+	Samples
LM2990T-5.2/NOPB	ACTIVE	TO-220	NDE	3	45	RoHS & Green	SN	Level-1-NA-UNLIM	-40 to 125	LM2990T -5.2 P+	Samples

(1) The marketing status values are defined as follows:

ACTIVE: Product device recommended for new designs.

LIFEBUY: TI has announced that the device will be discontinued, and a lifetime-buy period is in effect.

NRND: Not recommended for new designs. Device is in production to support existing customers, but TI does not recommend using this part in a new design.

PREVIEW: Device has been announced but is not in production. Samples may or may not be available.

OBSELETE: TI has discontinued the production of the device.

(2) **RoHS:** TI defines "RoHS" to mean semiconductor products that are compliant with the current EU RoHS requirements for all 10 RoHS substances, including the requirement that RoHS substance do not exceed 0.1% by weight in homogeneous materials. Where designed to be soldered at high temperatures, "RoHS" products are suitable for use in specified lead-free processes. TI may reference these types of products as "Pb-Free".

RoHS Exempt: TI defines "RoHS Exempt" to mean products that contain lead but are compliant with EU RoHS pursuant to a specific EU RoHS exemption.

Green: TI defines "Green" to mean the content of Chlorine (Cl) and Bromine (Br) based flame retardants meet JS709B low halogen requirements of <=1000ppm threshold. Antimony trioxide based flame retardants must also meet the <=1000ppm threshold requirement.

(3) MSL, Peak Temp. - The Moisture Sensitivity Level rating according to the JEDEC industry standard classifications, and peak solder temperature.

(4) There may be additional marking, which relates to the logo, the lot trace code information, or the environmental category on the device.

(5) Multiple Device Markings will be inside parentheses. Only one Device Marking contained in parentheses and separated by a "-" will appear on a device. If a line is indented then it is a continuation of the previous line and the two combined represent the entire Device Marking for that device.

(6) Lead finish/Ball material - Orderable Devices may have multiple material finish options. Finish options are separated by a vertical ruled line. Lead finish/Ball material values may wrap to two lines if the finish value exceeds the maximum column width.

Important Information and Disclaimer:The information provided on this page represents TI's knowledge and belief as of the date that it is provided. TI bases its knowledge and belief on information provided by third parties, and makes no representation or warranty as to the accuracy of such information. Efforts are underway to better integrate information from third parties. TI has taken and continues to take reasonable steps to provide representative and accurate information but may not have conducted destructive testing or chemical analysis on incoming materials and chemicals. TI and TI suppliers consider certain information to be proprietary, and thus CAS numbers and other limited information may not be available for release.

In no event shall TI's liability arising out of such information exceed the total purchase price of the TI part(s) at issue in this document sold by TI to Customer on an annual basis.

TAPE AND REEL INFORMATION

QUADRANT ASSIGNMENTS FOR PIN 1 ORIENTATION IN TAPE

*All dimensions are nominal

Device	Package Type	Package Drawing	Pins	SPQ	Reel Diameter (mm)	Reel Width W1 (mm)	A0 (mm)	B0 (mm)	K0 (mm)	P1 (mm)	W (mm)	Pin1 Quadrant
LM2990SX-12	DDPAK/ TO-263	KTT	3	500	330.0	24.4	10.75	14.85	5.0	16.0	24.0	Q2
LM2990SX-12/NOPB	DDPAK/ TO-263	KTT	3	500	330.0	24.4	10.75	14.85	5.0	16.0	24.0	Q2
LM2990SX-15	DDPAK/ TO-263	KTT	3	500	330.0	24.4	10.75	14.85	5.0	16.0	24.0	Q2
LM2990SX-15/NOPB	DDPAK/ TO-263	KTT	3	500	330.0	24.4	10.75	14.85	5.0	16.0	24.0	Q2
LM2990SX-5.0	DDPAK/ TO-263	KTT	3	500	330.0	24.4	10.75	14.85	5.0	16.0	24.0	Q2
LM2990SX-5.0/NOPB	DDPAK/ TO-263	KTT	3	500	330.0	24.4	10.75	14.85	5.0	16.0	24.0	Q2

TAPE AND REEL BOX DIMENSIONS

*All dimensions are nominal

Device	Package Type	Package Drawing	Pins	SPQ	Length (mm)	Width (mm)	Height (mm)
LM2990SX-12	DDPAK/TO-263	KTT	3	500	367.0	367.0	45.0
LM2990SX-12/NOPB	DDPAK/TO-263	KTT	3	500	367.0	367.0	45.0
LM2990SX-15	DDPAK/TO-263	KTT	3	500	367.0	367.0	45.0
LM2990SX-15/NOPB	DDPAK/TO-263	KTT	3	500	367.0	367.0	45.0
LM2990SX-5.0	DDPAK/TO-263	KTT	3	500	367.0	367.0	45.0
LM2990SX-5.0/NOPB	DDPAK/TO-263	KTT	3	500	367.0	367.0	45.0

TUBE

*All dimensions are nominal

Device	Package Name	Package Type	Pins	SPQ	L (mm)	W (mm)	T (µm)	B (mm)
LM2990S-12	KTT	TO-263	3	45	502	25	8204.2	9.19
LM2990S-12	KTT	TO-263	3	45	502	25	8204.2	9.19
LM2990S-12/NOPB	KTT	TO-263	3	45	502	25	8204.2	9.19
LM2990S-15	KTT	TO-263	3	45	502	25	8204.2	9.19
LM2990S-15	KTT	TO-263	3	45	502	25	8204.2	9.19
LM2990S-15/NOPB	KTT	TO-263	3	45	502	25	8204.2	9.19
LM2990S-5.0	KTT	TO-263	3	45	502	25	8204.2	9.19
LM2990S-5.0	KTT	TO-263	3	45	502	25	8204.2	9.19
LM2990S-5.0/NOPB	KTT	TO-263	3	45	502	25	8204.2	9.19
LM2990T-12	NDE	TO-220	3	45	502	33	6985	4.06
LM2990T-12	NDE	TO-220	3	45	502	33	6985	4.06
LM2990T-12/NOPB	NDE	TO-220	3	45	502	33	6985	4.06
LM2990T-15	NDE	TO-220	3	45	502	33	6985	4.06
LM2990T-15	NDE	TO-220	3	45	502	33	6985	4.06
LM2990T-15/NOPB	NDE	TO-220	3	45	502	33	6985	4.06
LM2990T-5.0	NDE	TO-220	3	45	502	33	6985	4.06
LM2990T-5.0	NDE	TO-220	3	45	502	33	6985	4.06
LM2990T-5.0/NOPB	NDE	TO-220	3	45	502	33	6985	4.06
LM2990T-5.2/NOPB	NDE	TO-220	3	45	502	33	6985	4.06

NDE0003B



KTT (R-PSFM-G3)

PLASTIC FLANGE-MOUNT PACKAGE

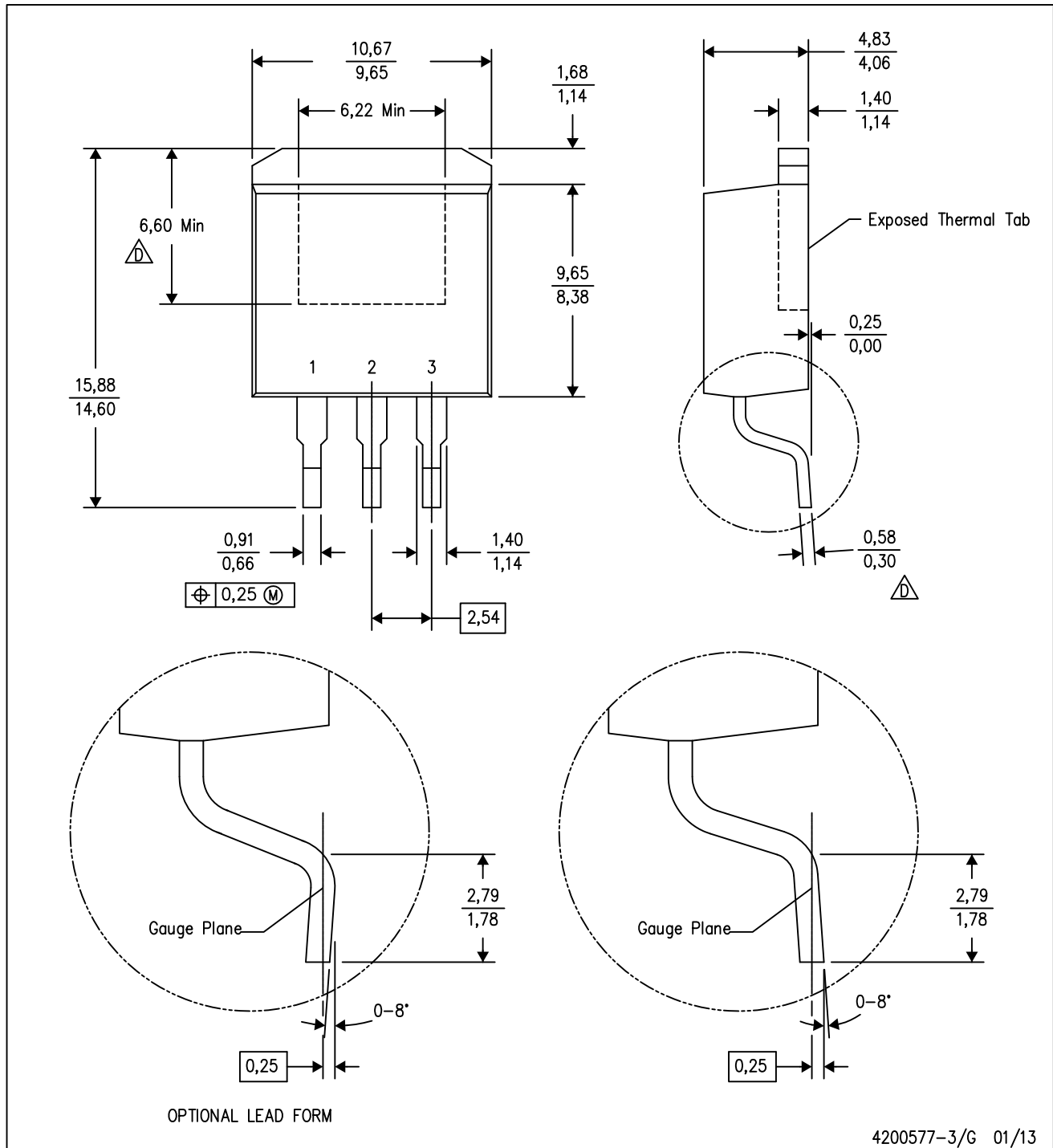

4200577-3/G 01/13

- NOTES:
- A. All linear dimensions are in millimeters.
 - B. This drawing is subject to change without notice.
 - C. Body dimensions do not include mold flash or protrusion. Mold flash or protrusion not to exceed 0.005 (0,13) per side.
- Falls within JEDEC TO-263 variation AA, except minimum lead thickness and minimum exposed pad length.

IMPORTANT NOTICE AND DISCLAIMER

TI PROVIDES TECHNICAL AND RELIABILITY DATA (INCLUDING DATA SHEETS), DESIGN RESOURCES (INCLUDING REFERENCE DESIGNS), APPLICATION OR OTHER DESIGN ADVICE, WEB TOOLS, SAFETY INFORMATION, AND OTHER RESOURCES "AS IS" AND WITH ALL FAULTS, AND DISCLAIMS ALL WARRANTIES, EXPRESS AND IMPLIED, INCLUDING WITHOUT LIMITATION ANY IMPLIED WARRANTIES OF MERCHANTABILITY, FITNESS FOR A PARTICULAR PURPOSE OR NON-INFRINGEMENT OF THIRD PARTY INTELLECTUAL PROPERTY RIGHTS.

These resources are intended for skilled developers designing with TI products. You are solely responsible for (1) selecting the appropriate TI products for your application, (2) designing, validating and testing your application, and (3) ensuring your application meets applicable standards, and any other safety, security, regulatory or other requirements.

These resources are subject to change without notice. TI grants you permission to use these resources only for development of an application that uses the TI products described in the resource. Other reproduction and display of these resources is prohibited. No license is granted to any other TI intellectual property right or to any third party intellectual property right. TI disclaims responsibility for, and you will fully indemnify TI and its representatives against, any claims, damages, costs, losses, and liabilities arising out of your use of these resources.

TI's products are provided subject to [TI's Terms of Sale](#) or other applicable terms available either on [ti.com](https://www.ti.com) or provided in conjunction with such TI products. TI's provision of these resources does not expand or otherwise alter TI's applicable warranties or warranty disclaimers for TI products.

TI objects to and rejects any additional or different terms you may have proposed.

Mailing Address: Texas Instruments, Post Office Box 655303, Dallas, Texas 75265
Copyright © 2023, Texas Instruments Incorporated