

NVMFS5A160PLZ

MOSFET – Power, Single P-Channel

-60 V, -100 A, 7.7 mΩ



ON Semiconductor®

www.onsemi.com

Features

- Small Footprint (5 x 6 mm) for Compact Design
- Low $R_{DS(on)}$ to Minimize Conduction Losses
- NVMFS5A160PLZWf: Wettable Flank Option for Enhanced Optical Inspection
- AEC-Q101 Qualified and PPAP Capable
- These Devices are Pb-Free and are RoHS Compliant

SPECIFICATION MAXIMUM RATINGS ($T_J = 25^\circ\text{C}$ unless otherwise noted) (Notes 1, 2, 3)

Symbol	Parameter		Value	Unit	
V_{DSS}	Drain to Source Voltage		-60	V	
V_{GS}	Gate to Source Voltage		± 20	V	
I_D	Continuous Drain, Current $R_{\theta JC}$, (Notes 1, 3)	Steady State	$T_C = 25^\circ\text{C}$	-100	A
P_D			Power Dissipation $R_{\theta JC}$ (Note 1)	$T_C = 25^\circ\text{C}$	200
I_D	Continuous Drain: Current $R_{\theta JA}$ (Notes 1, 2, 3)	Steady State	$T_A = 25^\circ\text{C}$	-15	A
P_D			Power Dissipation $R_{\theta JA}$ (Note 1, 2)	$T_A = 25^\circ\text{C}$	3.8
I_{DP}	Pulsed Drain Current	$PW \leq 10 \mu\text{s}$, duty cycle $\leq 1\%$	-400	A	
T_J, T_{STG}	Operating Junction and Storage Temperature		-55 to +175	$^\circ\text{C}$	
I_S	Source Current (Body Diode)		-100	A	
E_{AS}	Single Pulse Drain to Source Avalanche Energy ($L = 1.0 \text{ mH}$, $I_{L(pk)} = -26 \text{ A}$)		335	mJ	
T_L	Lead Temperature for Soldering Purposes (1/8" from case for 10 s)		260	$^\circ\text{C}$	

Stresses exceeding those listed in the Maximum Ratings table may damage the device. If any of these limits are exceeded, device functionality should not be assumed, damage may occur and reliability may be affected.

THERMAL CHARACTERISTICS

Symbol	Parameter	Value	Unit
$R_{\theta JC}$	Junction to Case Steady State	0.75	$^\circ\text{C/W}$
$R_{\theta JA}$	Junction to Ambient Steady State (Note 3)	39	

1. The entire application environment impacts the thermal resistance values shown, they are not constants and are only valid for the particular conditions noted.
2. Surface mounted on FR4 board using a 650 mm², 2 oz. Cu pad.
3. Maximum current for pulses as long as 1 second is higher but is dependent on pulse duration and duty cycle.

V_{DSS}	$R_{DS(on)}$ MAX	I_D MAX
-60 V	7.7 mΩ @ -10 V	-100 A
	10.5 mΩ @ -4.5 V	

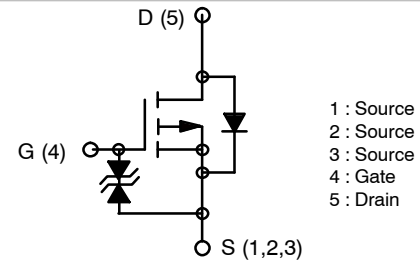

P-CHANNEL MOSFET

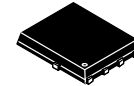

DFN5 (SO-8FL)

MARKING DIAGRAM

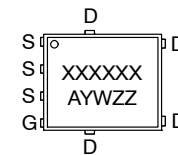

- XXXXXX = Specific Device Code
5A160L(NVMFS5A160PLZ)
160LWF(NVMFS5A160PLZWf)
- A = Assembly Location
- Y = Year
- W = Work Week
- ZZ = Lot Traceability

ORDERING INFORMATION

See detailed ordering and shipping information on page 7 of this data sheet.

NVMFS5A160PLZ

ELECTRICAL CHARACTERISTICS (T_J = 25°C unless otherwise noted)

Symbol	Parameter	Test Condition	Min	Typ	Max	Unit
--------	-----------	----------------	-----	-----	-----	------

OFF CHARACTERISTICS

V _{(BR)DSS}	Drain to Source Breakdown Voltage	I _D = -1 mA, V _{GS} = 0 V	-60			V
I _{DSS}	Zero Gate Voltage Drain Current	V _{DS} = -60 V, V _{GS} = 0 V	T _J = 25°C		-1.0	μA
			T _J = 100°C (Note 4)		-100	μA
I _{GSS}	Gate to Source Leakage Current	V _{GS} = ±16 V, V _{DS} = 0 V			±10	μA

ON CHARACTERISTICS (Note 5)

V _{GS(th)}	Gate Threshold Voltage	V _{DS} = -10 V, I _D = -1 mA	-1.2		-2.6	V
R _{DS(on)}	Drain to Source On Resistance	V _{GS} = -10 V	I _D = -50 A	5.8	7.7	mΩ
		V _{GS} = -4.5 V	I _D = -50 A	7.3	10.5	
g _{FS}	Forward Transconductance	V _{DS} = -10 V, I _D = -50 A		119		S

CHARGES, CAPACITANCES & GATE RESISTANCE

C _{iss}	Input Capacitance	V _{GS} = 0 V, f = 1 MHz V _{DS} = -20 V,			7700	pF
C _{oss}	Output Capacitance				720	
C _{rss}	Reverse Transfer Capacitance				540	
Q _{g(tot)}	Total Gate Charge	V _{GS} = -10 V, I _D = -50 A V _{DS} = -36 V,			160	nC
Q _{gs}	Gate to Source Charge				24	
Q _{gd}	Gate to Drain Charge				45	

SWITCHING CHARACTERISTICS (Note 6)

t _{d(on)}	Turn-On Delay Time	V _{DS} = -36 V, I _D = -50 A, V _{GS} = -10 V, R _G = 50 Ω			50	ns
t _r	Rise Time				690	
t _{d(off)}	Turn-Off Delay Time				645	
t _f	Fall Time				643	

DRAIN-SOURCE DIODE CHARACTERISTICS

V _{SD}	Forward Diode Voltage	V _{GS} = 0 V, I _S = -50 A			-0.83	-1.5	V
t _{rr}	Reverse Recovery Time	V _{GS} = 0 V, I _S = -50 A			93		ns
Q _{rr}	Reverse Recovery Charge	di/dt = 100 A/μs			218		nC

Product parametric performance is indicated in the Electrical Characteristics for the listed test conditions, unless otherwise noted. Product performance may not be indicated by the Electrical Characteristics if operated under different conditions.

4. The maximum value is specified by design at T_J = 100 °C. Product is not tested to this condition in production.

5. Pulse Test: pulse width ≤ 300μs, duty cycle ≤ 2%.

6. Switching characteristics are independent of operating junction temperatures.

TYPICAL CHARACTERISTICS

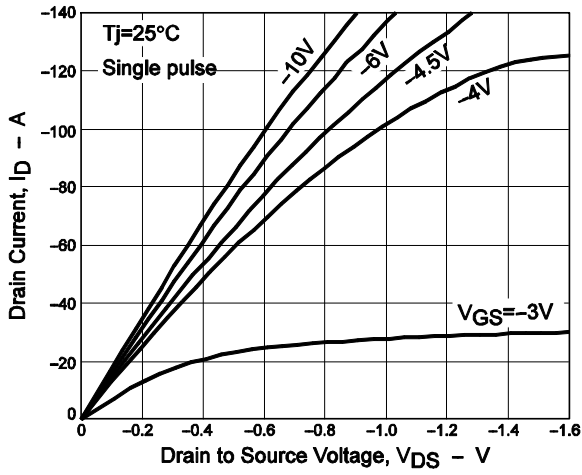

Figure 1. $I_D - V_{DS}$

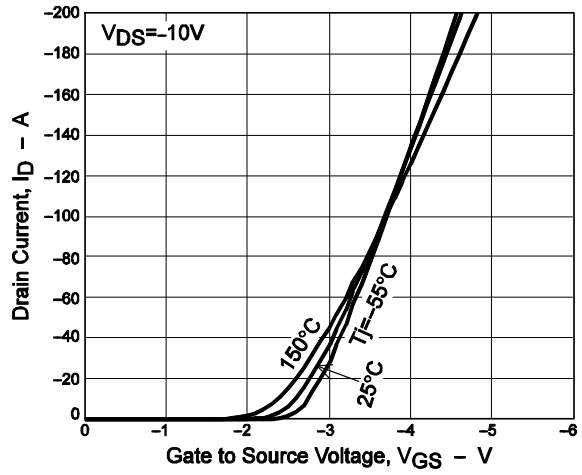

Figure 2. $I_D - V_{GS}$

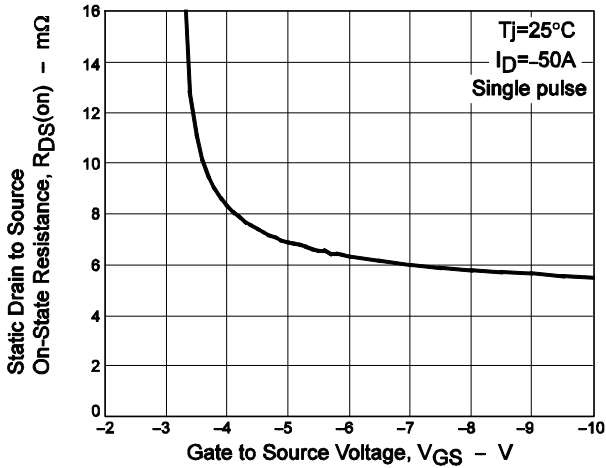

Figure 3. $R_{DS(on)} - V_{GS}$

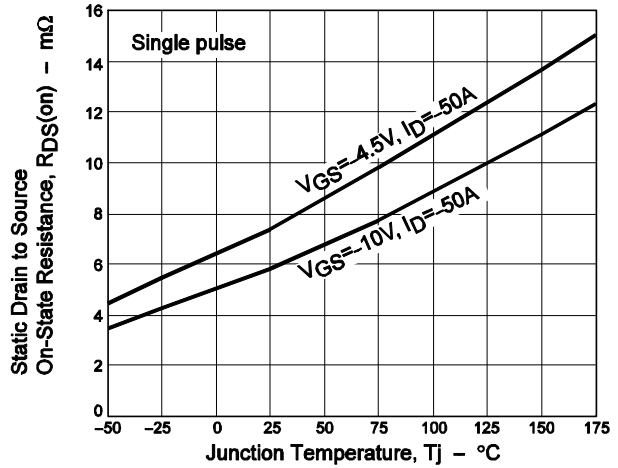

Figure 4. $R_{DS(on)} - T_J$

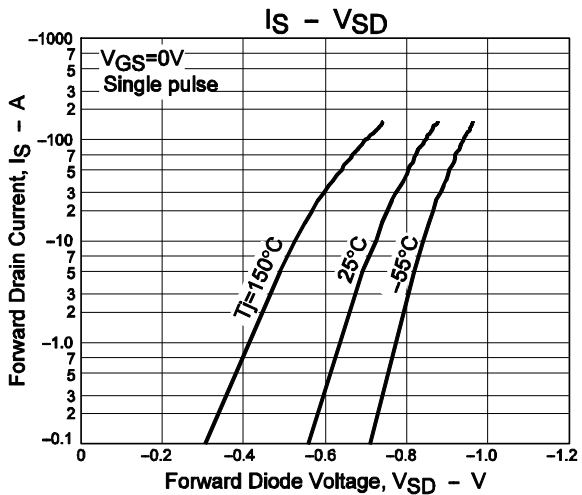

Figure 5. $I_S - V_{SD}$

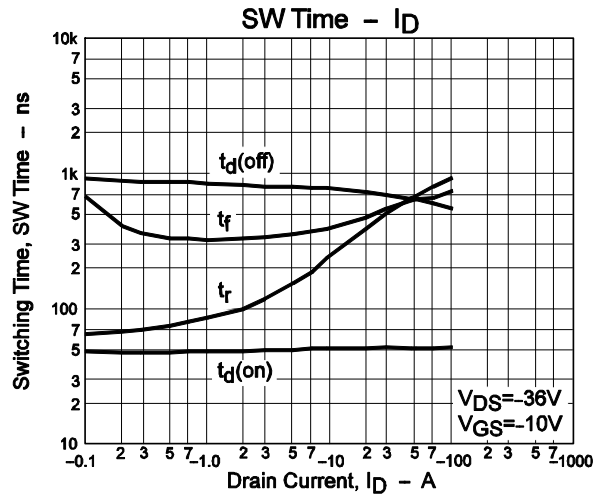

Figure 6. SW Time - I_D

NVMFS5A160PLZ

TYPICAL CHARACTERISTICS

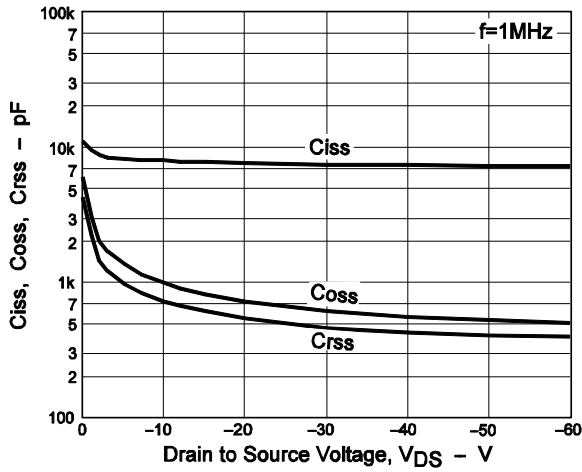

Figure 7. Ciss, Coss, Crss - V_{DS}

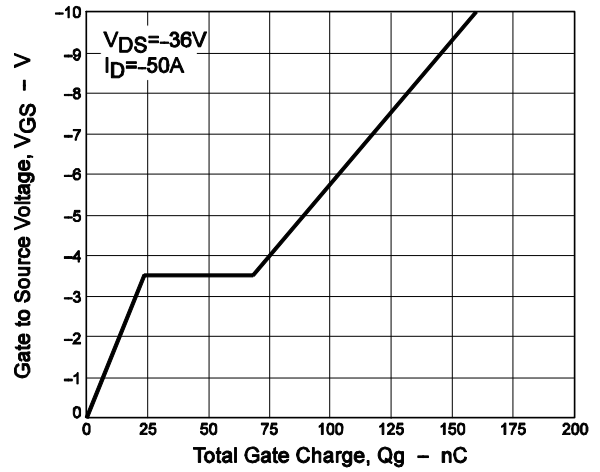

Figure 8. V_{GS} - Q_g

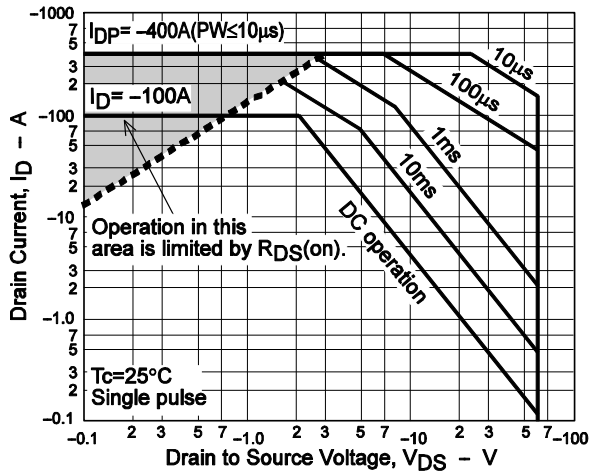

Figure 9. SOA

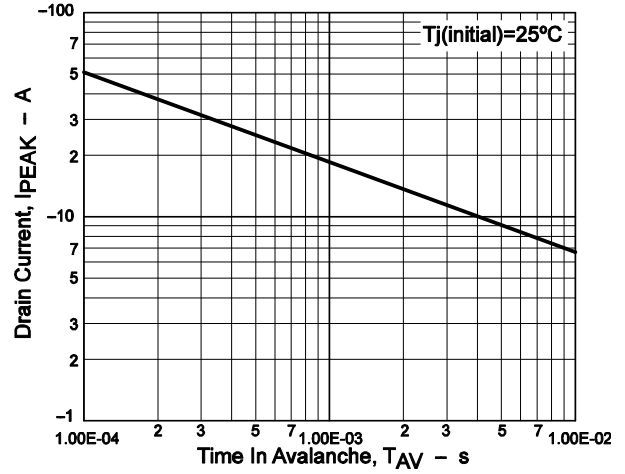

Figure 10. I_{PEAK} - T_{AV}

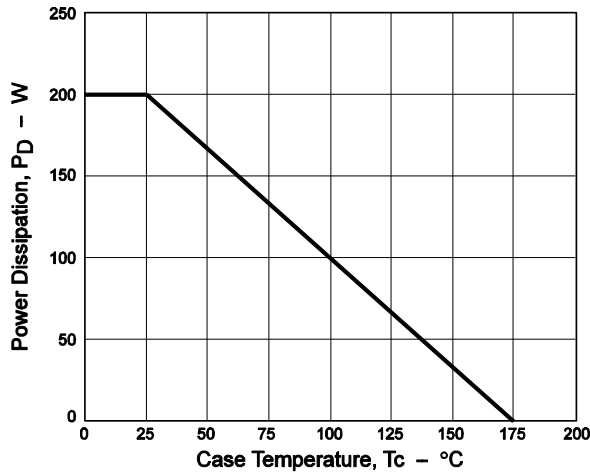

Figure 11. P_D - T_c

NVMFS5A160PLZ

TYPICAL CHARACTERISTICS

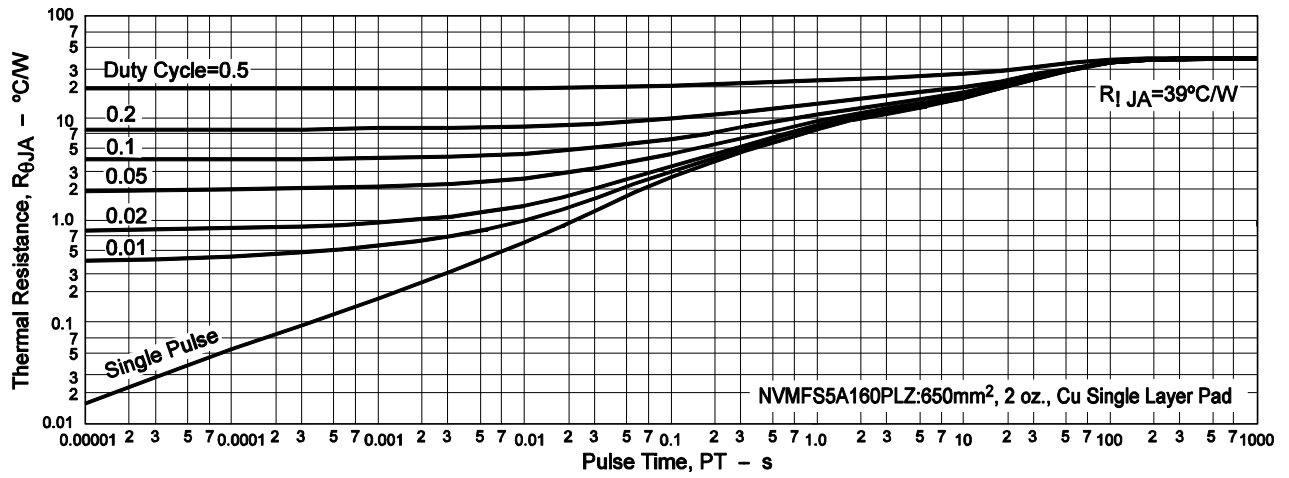

Figure 12. $R_{\theta JA}$ - Pulse Time

NVMFS5A160PLZ

ORDERING INFORMATION

Device	Marking	Package	Shipping (Qty / Packing) [†]
NVMFS5A160PLZT1G	5A160L	DFN5 5x6, 1.27P (SO-8FL) (Pb-Free)	1.500 / Tape & Reel
NVMFS5A160PLZWFT1G	160LWF	DFN5 5x6, 1.27P (SO-8FL) (Pb-Free, Wettable Flanks)	1.500 / Tape & Reel
NVMFS5A160PLZT3G	5A160L	DFN5 5x6, 1.27P (SO-8FL) (Pb-Free)	5.000 / Tape & Reel
NVMFS5A160PLZWFT3G	160LWF	DFN5 5x6, 1.27P (SO-8FL) (Pb-Free, Wettable Flanks)	5.000 / Tape & Reel

[†]For information on tape and reel specifications, including part orientation and tape sizes, please refer to our Tape and Reel Packaging Specifications Brochure, BRD8011/D.

MECHANICAL CASE OUTLINE

PACKAGE DIMENSIONS

ON Semiconductor®

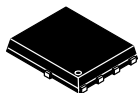

1
SCALE 2:1

DFN5 5x6, 1.27P
(SO-8FL)
CASE 488AA
ISSUE N

DATE 25 JUN 2018

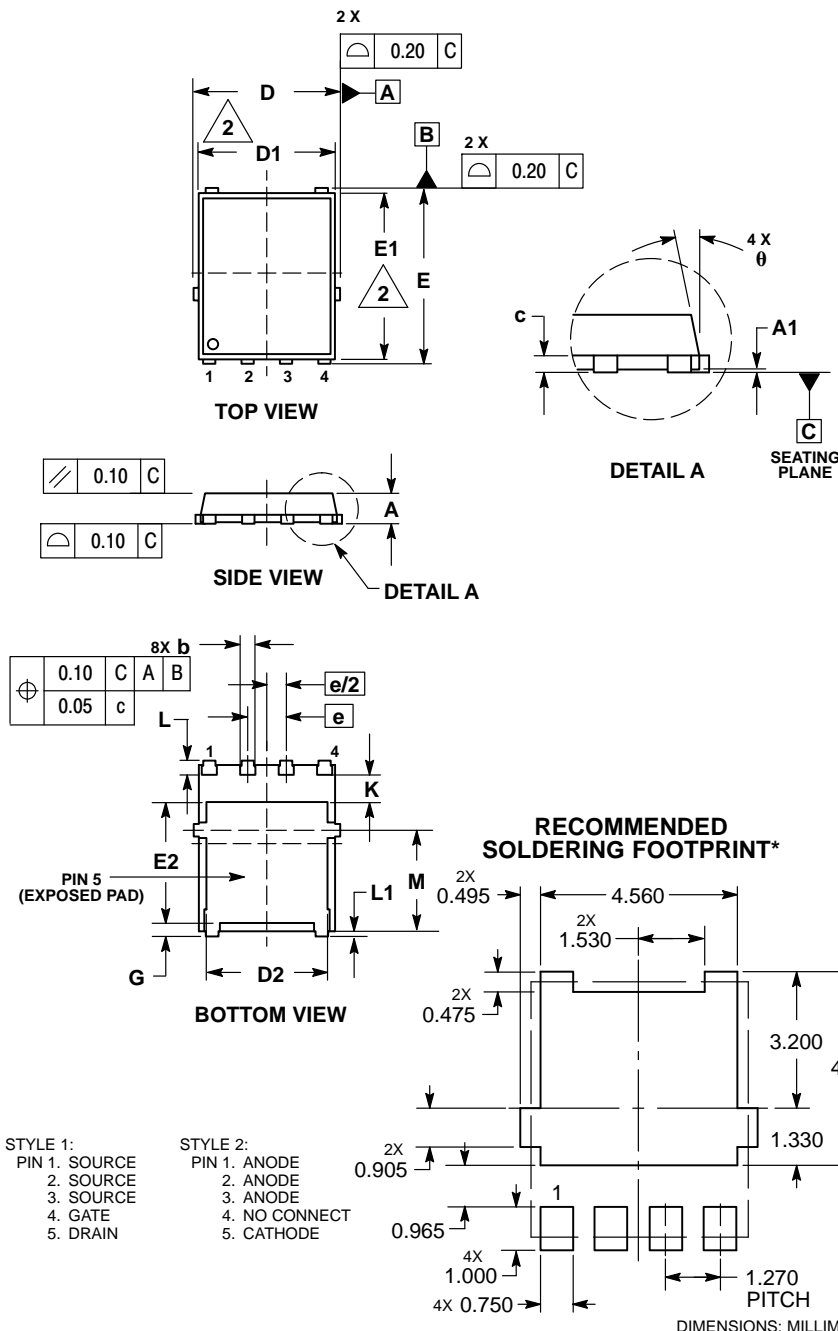

- NOTES:
1. DIMENSIONING AND TOLERANCING PER ASME Y14.5M, 1994.
 2. CONTROLLING DIMENSION: MILLIMETER.
 3. DIMENSION D1 AND E1 DO NOT INCLUDE MOLD FLASH PROTRUSIONS OR GATE BURRS.

DIM	MILLIMETERS		
	MIN	NOM	MAX
A	0.90	1.00	1.10
A1	0.00	---	0.05
b	0.33	0.41	0.51
c	0.23	0.28	0.33
D	5.00	5.15	5.30
D1	4.70	4.90	5.10
D2	3.80	4.00	4.20
E	6.00	6.15	6.30
E1	5.70	5.90	6.10
E2	3.45	3.65	3.85
e	1.27 BSC		
G	0.51	0.575	0.71
K	1.20	1.35	1.50
L	0.51	0.575	0.71
L1	0.125 REF		
M	3.00	3.40	3.80
θ	0°	---	12°

GENERIC MARKING DIAGRAM*



- XXXXXX = Specific Device Code
- A = Assembly Location
- Y = Year
- W = Work Week
- ZZ = Lot Traceability

*This information is generic. Please refer to device data sheet for actual part marking. Pb-Free indicator, "G" or microdot "•", may or may not be present. Some products may not follow the Generic Marking.

- STYLE 1:
PIN 1. SOURCE
2. SOURCE
3. SOURCE
4. GATE
5. DRAIN
- STYLE 2:
PIN 1. ANODE
2. ANODE
3. ANODE
4. NO CONNECT
5. CATHODE

*For additional information on our Pb-Free strategy and soldering details, please download the ON Semiconductor Soldering and Mounting Techniques Reference Manual, SOLDERRM/D.

DOCUMENT NUMBER:	98AON14036D	Electronic versions are uncontrolled except when accessed directly from the Document Repository. Printed versions are uncontrolled except when stamped "CONTROLLED COPY" in red.
DESCRIPTION:	DFN5 5x6, 1.27P (SO-8FL)	PAGE 1 OF 1

ON Semiconductor and ON are trademarks of Semiconductor Components Industries, LLC dba ON Semiconductor or its subsidiaries in the United States and/or other countries. ON Semiconductor reserves the right to make changes without further notice to any products herein. ON Semiconductor makes no warranty, representation or guarantee regarding the suitability of its products for any particular purpose, nor does ON Semiconductor assume any liability arising out of the application or use of any product or circuit, and specifically disclaims any and all liability, including without limitation special, consequential or incidental damages. ON Semiconductor does not convey any license under its patent rights nor the rights of others.

onsemi, **Onsemi**, and other names, marks, and brands are registered and/or common law trademarks of Semiconductor Components Industries, LLC dba "**onsemi**" or its affiliates and/or subsidiaries in the United States and/or other countries. **onsemi** owns the rights to a number of patents, trademarks, copyrights, trade secrets, and other intellectual property. A listing of **onsemi**'s product/patent coverage may be accessed at www.onsemi.com/site/pdf/Patent-Marking.pdf. **onsemi** reserves the right to make changes at any time to any products or information herein, without notice. The information herein is provided "as-is" and **onsemi** makes no warranty, representation or guarantee regarding the accuracy of the information, product features, availability, functionality, or suitability of its products for any particular purpose, nor does **onsemi** assume any liability arising out of the application or use of any product or circuit, and specifically disclaims any and all liability, including without limitation special, consequential or incidental damages. Buyer is responsible for its products and applications using **onsemi** products, including compliance with all laws, regulations and safety requirements or standards, regardless of any support or applications information provided by **onsemi**. "Typical" parameters which may be provided in **onsemi** data sheets and/or specifications can and do vary in different applications and actual performance may vary over time. All operating parameters, including "Typicals" must be validated for each customer application by customer's technical experts. **onsemi** does not convey any license under any of its intellectual property rights nor the rights of others. **onsemi** products are not designed, intended, or authorized for use as a critical component in life support systems or any FDA Class 3 medical devices or medical devices with a same or similar classification in a foreign jurisdiction or any devices intended for implantation in the human body. Should Buyer purchase or use **onsemi** products for any such unintended or unauthorized application, Buyer shall indemnify and hold **onsemi** and its officers, employees, subsidiaries, affiliates, and distributors harmless against all claims, costs, damages, and expenses, and reasonable attorney fees arising out of, directly or indirectly, any claim of personal injury or death associated with such unintended or unauthorized use, even if such claim alleges that **onsemi** was negligent regarding the design or manufacture of the part. **onsemi** is an Equal Opportunity/Affirmative Action Employer. This literature is subject to all applicable copyright laws and is not for resale in any manner.

PUBLICATION ORDERING INFORMATION

LITERATURE FULFILLMENT:

Email Requests to: orderlit@onsemi.com

onsemi Website: www.onsemi.com

TECHNICAL SUPPORT

North American Technical Support:
Voice Mail: 1 800-282-9855 Toll Free USA/Canada
Phone: 011 421 33 790 2910

Europe, Middle East and Africa Technical Support:

Phone: 00421 33 790 2910

For additional information, please contact your local Sales Representative