



PRODUCT SPECIFICATION

Model No.: FYQ-3042AUE-12-L5.6-P

Descriptions:
<ul style="list-style-type: none"> ■ 0.30 Inch Four Digits Display ■ Common Cathode ■ Emitting Color : Ultra Orange ■ Chip Material:AlGaInP ■ Black Face ■ Red Segment



CUSTOMER APPROVED SIGNATURES	APPROVED BY	SALES BY	PREPARED BY
			

NINGBO FORYARD OPTOELECTRONICS CO.,LTD

Add:NO.666 Jinghua Road, Hi-tech Park, Ningbo, Zhejiang, China

Zip:315103

Tel: 0086-574-87933652 87927870 87922206

Fax: 0086-574-87927917

E-mail:Sales@foryard.com (General)

Http://www.foryard.com

Model No.: FYQ-3042AUE-12-L5.6-P

Features -

1. 0.30 inch (7.60mm) digit height.
2. Case mold type.
3. RoHS compliant.
4. Low current operation
5. Low power consumption.
6. Easy mounting on P.C. board or socket.

Mechanical Dimensions -

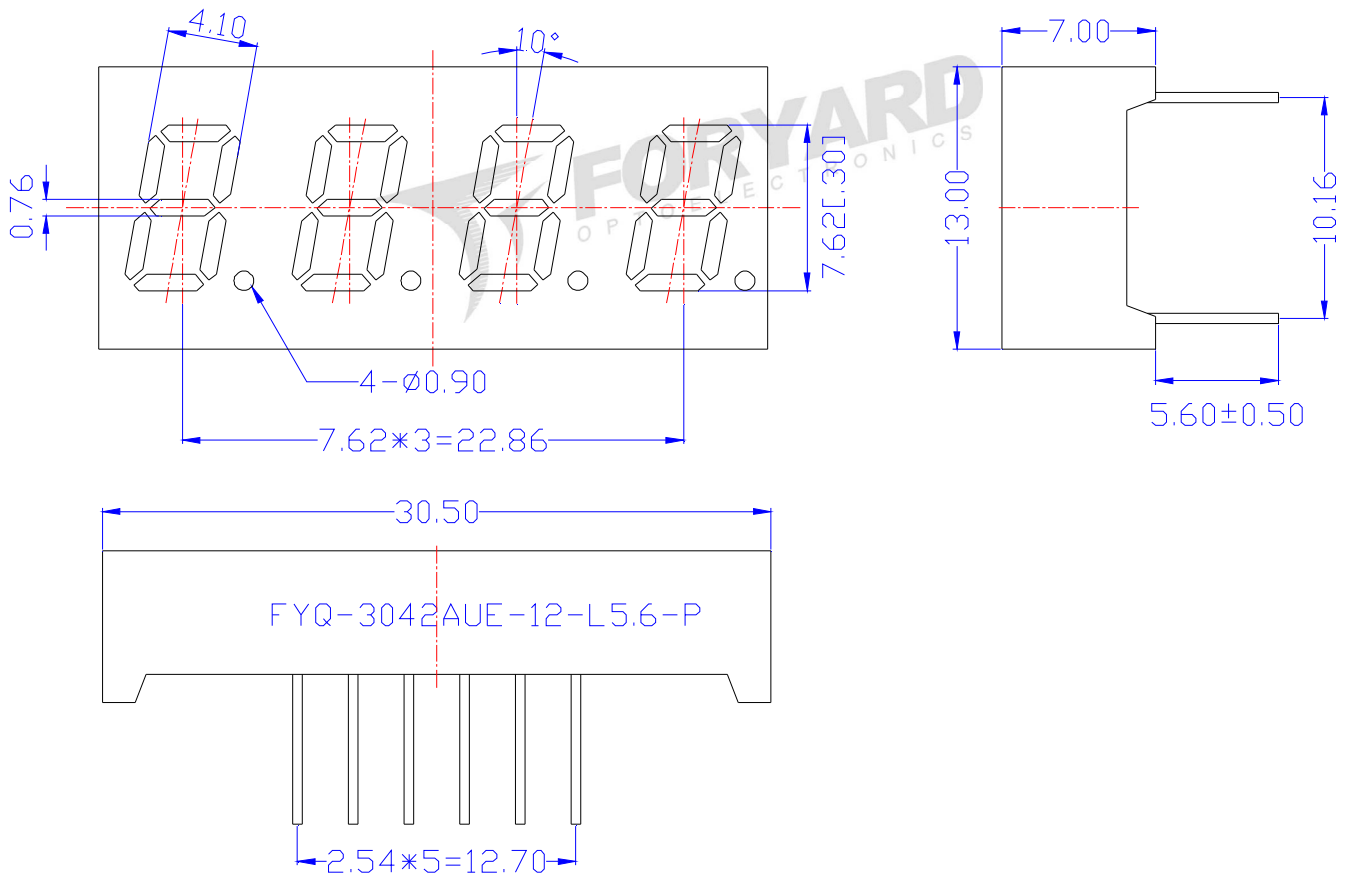

Notes:

1. All pins are $\Phi 0.045 [0.018]$ mm
2. Dimension in millimeter [inch], tolerance is $\pm 0.25 [0.010]$ and angle is $\pm 1^\circ$ unless otherwise noted.
3. Bending \leq Length * 1%.
4. The specifications, characteristics and technical data described in the datasheet are subject to change without prior notice.

Model No.: FYQ-3042AUE-12-L5.6-P

■ All Light On Segments Feature & Pin Position

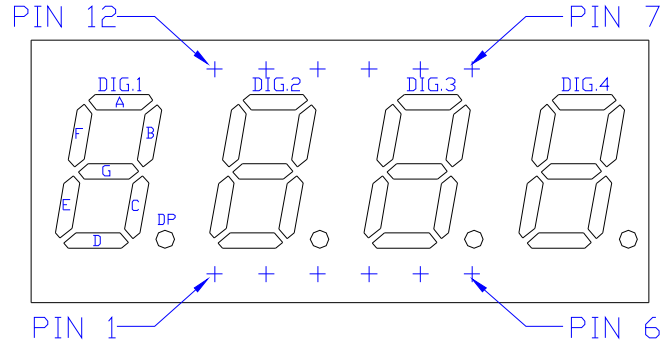

■ Internal Circuit Diagrams

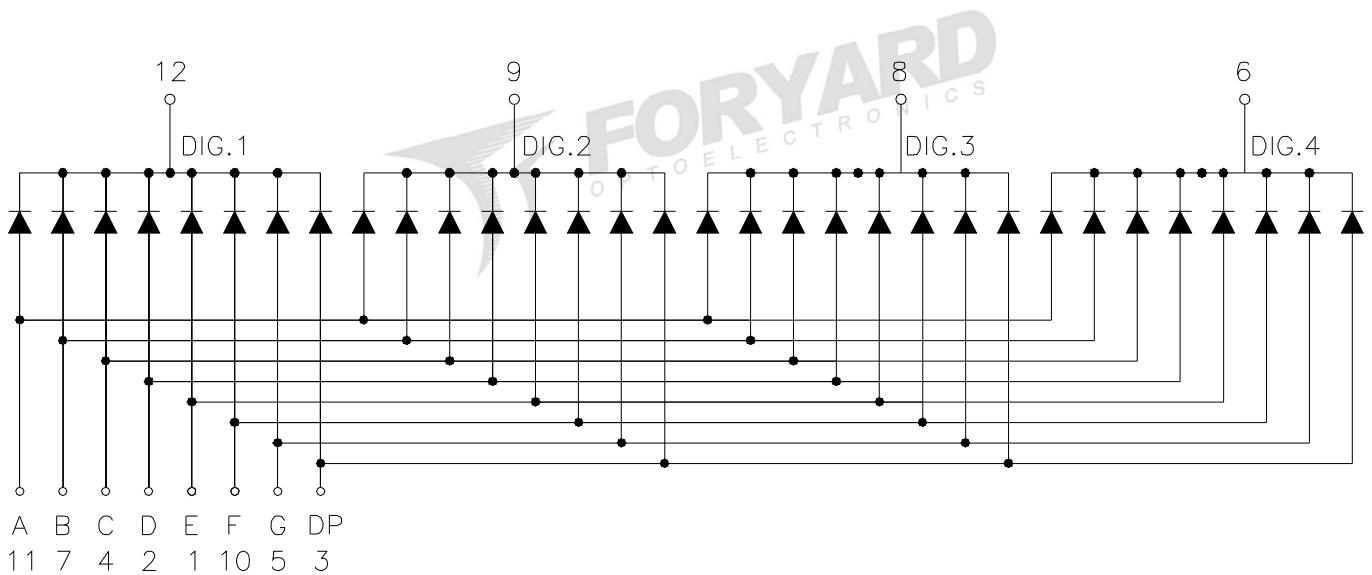

Model No.: FYQ-3042AUE-12-L5.6-P

■ Absolute maximum ratings

(Ta=25°C)

Parameter	Symbol	Test Condition	Value		Unit
			Min	Max	
Reverse Voltage	VR	IR=30	5	—	V
Forward Current	IF	—	—	30	mA
Power Dissipation	Pd	—	—	100	mW
Pulse Current	Ipeak	Duty=0.1mS,1KHz	—	150	mA
Operating Temperature	Topr	—	-40	+85	°C
Storage Temperature	Tstr	—	-40	+85	°C

■ Electrical-Optical Characteristics

● Color Code & Chip Characteristics:(Test Condition:IF=10mA)

(Ta=25°C)

Emitting Color		Dice Material	Peak Wave Length(λ_p)	Spectral Line halfwidth h($\Delta\lambda/2$)	Forward Voltage(VF) Unit:V		Luminous Intensity (Iv) Unit:mcd
					Typ	Max	
UE	Ultra Orange	AlGaInP	620nm	20nm	1.90	2.50	100~150
Segment-to-Segment Luminous Intensity ratio(Iv-M)						1.5:1	

Note:

- 1.Luminous Intensity is based on the Foryard standards.
- 2.Pay attention about static for InGaN

Model No.: FYQ-3042AUE-12-L5.6-P

Typical Electrical / Optical Characteristics Curves

(Ta = 25°C Unless Otherwise Noted)

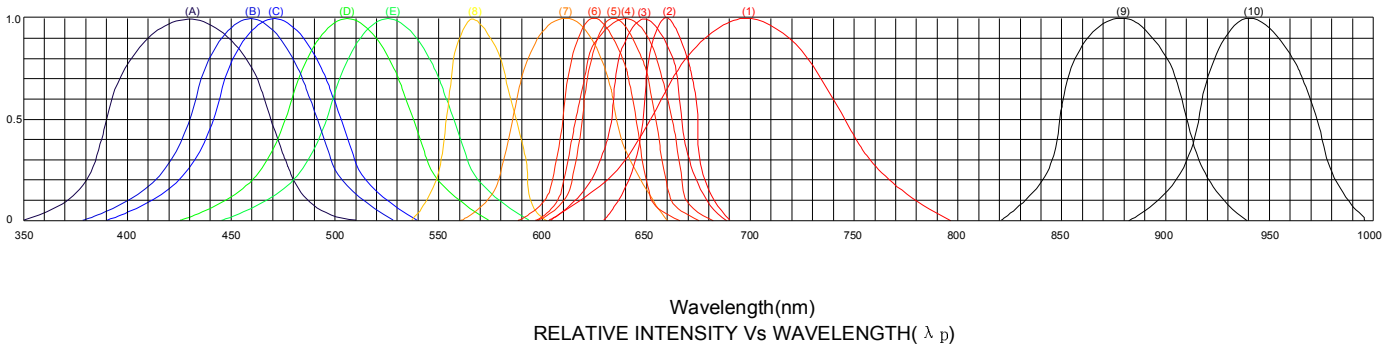

- | | |
|--------------------------------|------------------------------------|
| (1)-GaP 700nm/Red | (9)-GaAlAs 880nm |
| (2)-AlGaAs/SH 660nm/Hi Red | (10)-GaAs/GaAs & GaAlAs/GaAs 940nm |
| (3)-AlGaAs/DH 650nm/Super Red | (A)-GaN/SiC 430nm/Blue |
| (4)-AlGaInP/640nm/Ultra Hi Red | (B)-InGaN/SiC 460nm/Blue |
| (5)-AlGaInP/635nm/Ultra Red | (C)-InGaN/SiC 470nm/Blue |
| (6)-GaAlP/AlGaInP/625nm/Orange | (D)-InGaN/SiC 505nm/Ultra Green |
| (7)-GaAsP/AlGaInP 610nm/Amber | (E)-InGaN/SiC 525nm/Ultra Green |
| (8)-GaP 570nm/Yellow Green | |

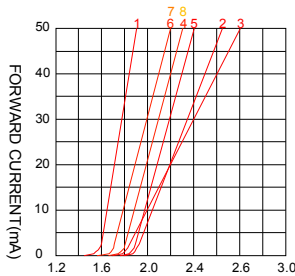

FORWARD VOLTAGE(Vf)
FORWARD CURRENT VS.
FORWARD VOLTAGE

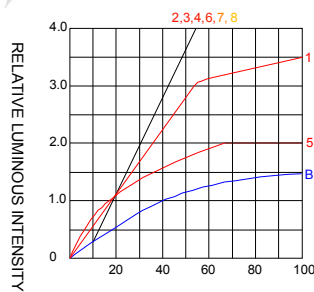

FORWARD CURRENT (mA)
RELATIVE LUMINOUS
INTENSITY VS FORWARD
CURRENT

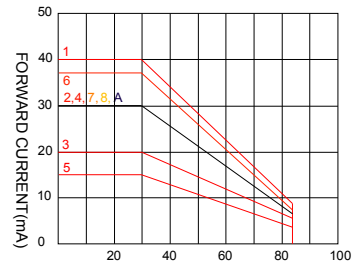

AMBIENT TEMPERATURE Ta(°C)
FORWARD CURRENT VS. AMBIENT
TEMPERATURE

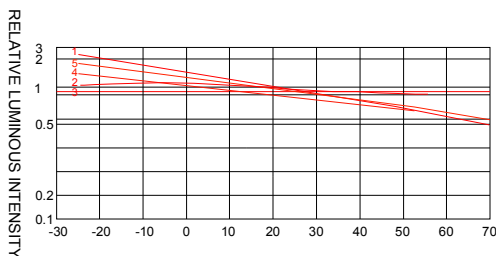

AMBIENT TEMPERATURE Ta(°C)

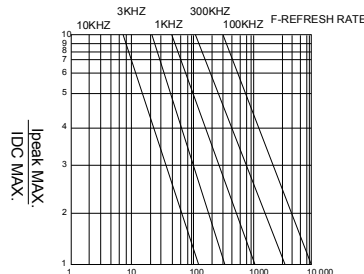

tp-PULSE DURATION uS
(1,2,3,4,6,8,B,D,J,K)

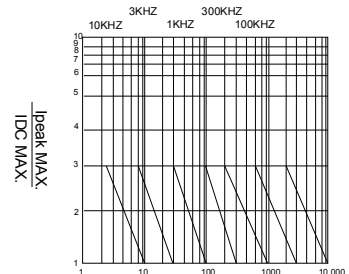

tp-PULSE DURATION uS
(5)

NOTE: 25°C free air temperature unless otherwise specified

Model No.: FYQ-3042AUE-12-L5.6-P

■ Precautions For Use -

1. Recommended Soldering conditions-Wave Soldering

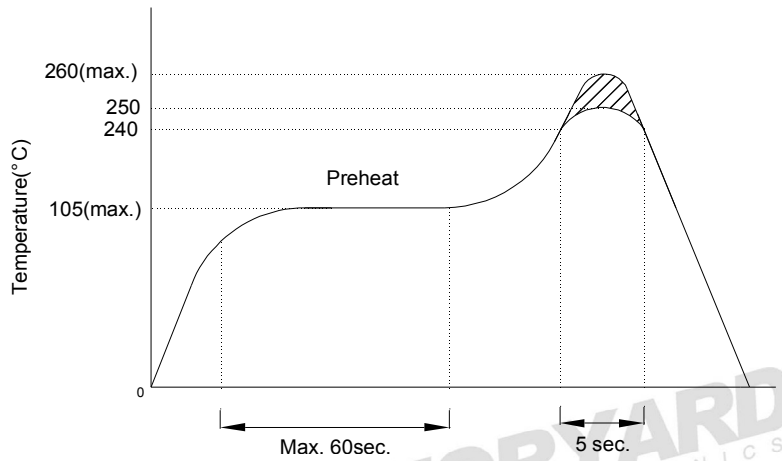

2. Soldering Iron

Basic SPEC. is ≤ 5 sec. When 260°C . If temperature is higher, time should be shorter ($+10^{\circ}\text{C} \rightarrow -1$ sec.).





Power dissipation of iron should be smaller than 15W, and temperature should be controllable.

Surface temperature of the device should be under 230°C .

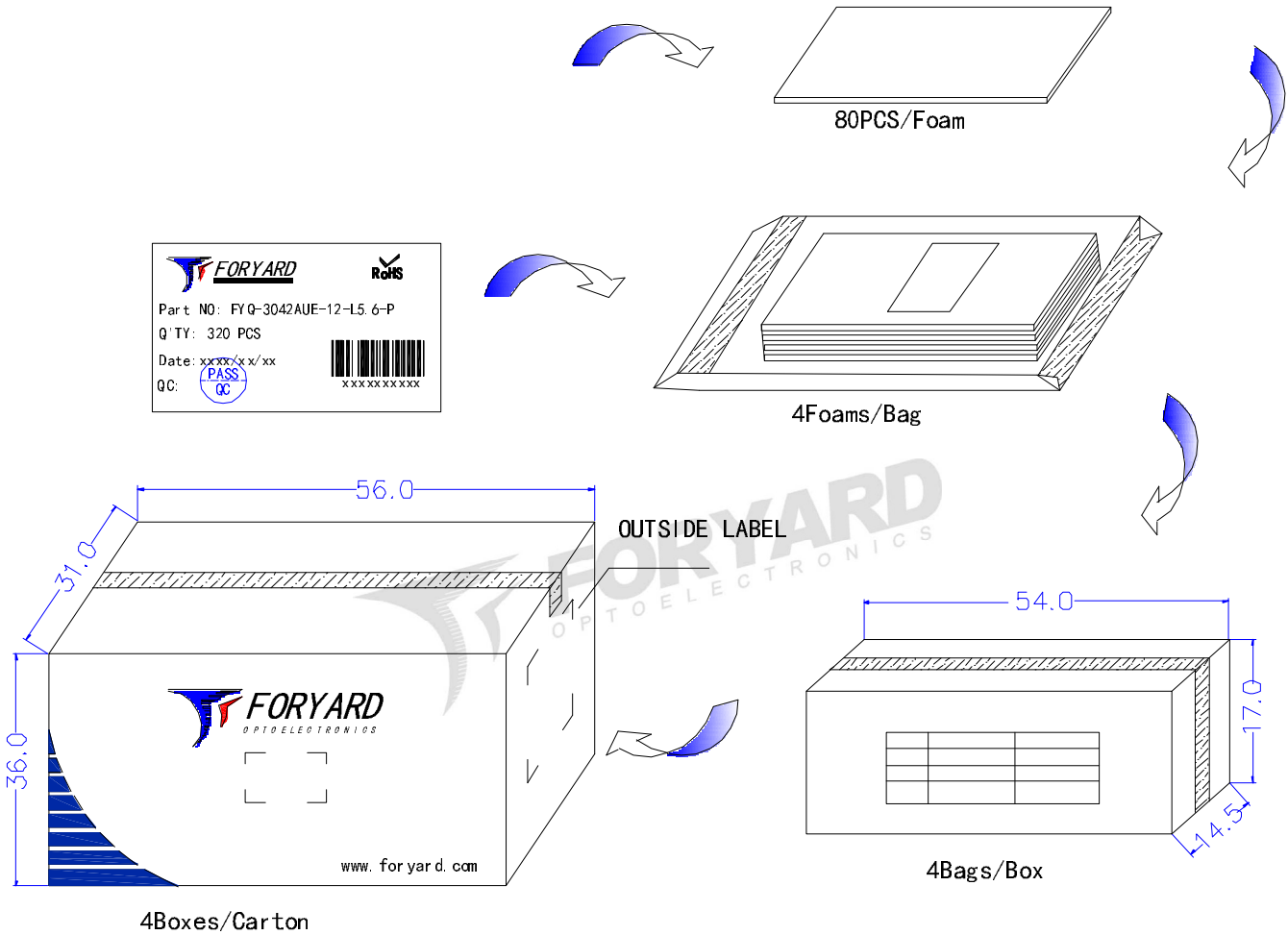
Model No.: FYQ-3042AUE-12-L5.6-P

■ Packing Diagram





 Part NO: FYQ-3042AUE-12-L5.6-P
 Q'TY: 320 PCS
 Date: xxxx/xx/xx
 QC: 

 xxxxxxxxxx



LED
 PN: FYQ-3042AUE-12-L5.6-P
 Qty: 5120 PCS
 Date: xxxx/xx/xx
 GW: 19.00KG QC: 
 NW: 17.00KG

 xxxxxxxxxx

OUTSIDE LABEL

Note: The specifications are subject to change without notice. Please contact us for updated information.