

Order No.: 1821708

Type: MC 0,5/ 3-G-2,54 SMD R24

PCB headers, Reflow soldering

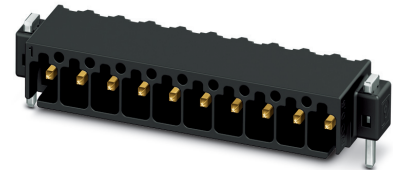

The figure shows the 10-position version

1 Main features



- | | | | |
|-------------------------|---------------------|------------------------|-----------------|
| • No. of pos. | 3 | • Nominal current | 6 A |
| • Nominal cross section | 0.5 mm ² | • Nominal voltage | 160 V |
| • Color | black (9005) | • Connection direction | 0 ° |
| • Pitch | 2.54 mm | • Type of packaging | 24 mm wide tape |
| • Mounting type | SMD soldering | | |

2 Your advantages

- ✓ Designed for integration into the SMT soldering process
- ✓ Additional solder anchors reduce the mechanical strain on the soldering spots
- ✓ Gold-plated contacts ensure transfer quality remains stable over the long term
- ✓ Supplied in tape-on-reel packing according to IEC 60286-3 for automated mounting



Make sure you always use the latest documentation.
It can be downloaded at: phoenixcontact.net/product/1821708

1821708 MC 0,5/ 3-G-2,54 SMD R24**3 Table of contents**

1	Main features.....	1
2	Your advantages	1
3	Table of contents	2
4	3D model in PDF can be activated (Acrobat Reader only).....	3
5	General Technical Data	4
6	Mounting.....	5
7	Material properties.....	5
8	Dimensions.....	6
9	Series drawing.....	7
10	Application.....	8
11	Packaging information	8
12	Blister drawing	9
13	Mechanical tests.....	11
14	Insertion and withdrawal forces	12
15	Electrical tests	13
16	Current carrying capacity/derating curves	14
17	Approvals / Certificates.....	15
18	Commercial Data.....	16
19	corresponding plugs	16
20	Accessories.....	16
21	Combination tests.....	17

1821708 MC 0,5/ 3-G-2,54 SMD R24

4 3D model in PDF can be activated (Acrobat Reader only)



1821708 MC 0,5/ 3-G-2,54 SMD R24**5 General Technical Data****5.1 item properties**

Order No.	1821708
Type	MC 0,5/ 3-G-2,54 SMD R24
Plug-in system	MICRO COMBICON - FMC 0,5
Product type	PCB headers
Type of contact	Male connector
Range of articles	MC 0,5/..-G-SMD
Pitch	2.54 mm
Range of positions	2...16
Number of positions	3
Number of levels	1
Number of connections	3
Number of potentials	3
Mounting type	SMD soldering
Connection direction of the connector to the PCB	0 °
Pin layout	Linear pad geometry
Solder pins per potential	1
Product note	Sample values available under SAMPLE MC...

1821708 MC 0,5/ 3-G-2,54 SMD R24**6 Mounting****6.1 Flange fixing**

Type of locking	without
Mounting flange	without

7 Material properties**7.1 Material of metal parts**

Note	WEEE/RoHS-compliant, whisker-free acc. to IEC 60068-2-82/JEDEC JESD 201
Contact material	Cu alloy
Surface contact area	Nickel (2 - 4 µm Ni) , Gold (0.25 Au)
Soldering area surface	Nickel (2 - 4 µm Ni) , Gold (0.25 Au)
Surface characteristics	Completely gold-plated
Insulating material data	Housing
Color	black (9005)
Insulating material	LCP
Insulating material group	IIIa
CTI according to IEC 60112	175
Flammability rating according to UL 94	V0

1821708 MC 0,5/ 3-G-2,54 SMD R24**8 Dimensions****8.1 Dimensions for the product**

Length	7.1 mm
Width	12.2 mm
Height (without solder pin)	4.85 mm
Total height	4.85 mm
Dimension a	5.08 mm

9 Series drawing

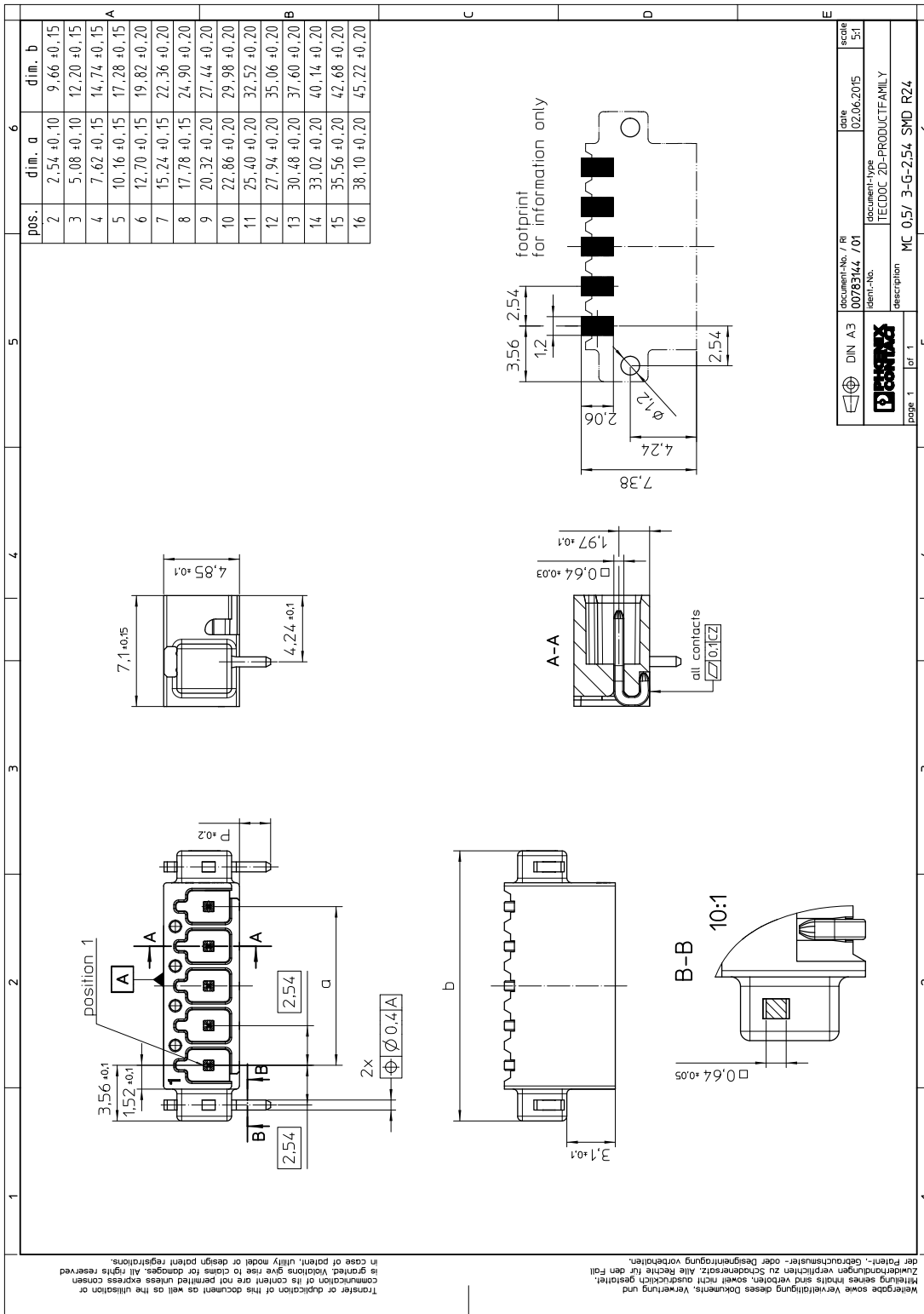

1821708 MC 0,5/ 3-G-2,54 SMD R24**10 Application****11 Packaging information**

Type of packaging	24 mm wide tape
Pieces per package	465
Outer packaging type	Transparent-Bag
ESD level	(D) electrostatically conductive
Specification	DIN EN 61340-5-1 (VDE 0300-5-1): 2008-07
[W] tape width	24 mm
[A] coil diameter	330 mm
[W2] coil overall dimension	30.4 mm
Number of products per coil	465

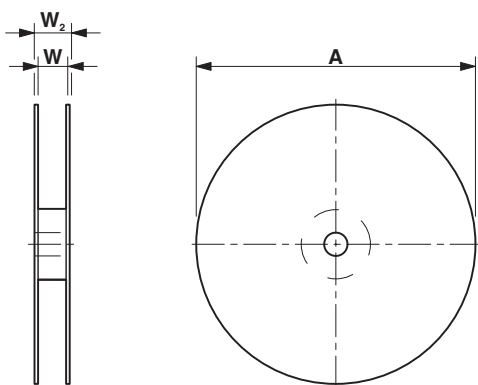

1821708 MC 0,5/ 3-G-2,54 SMD R24

12 Blister drawing

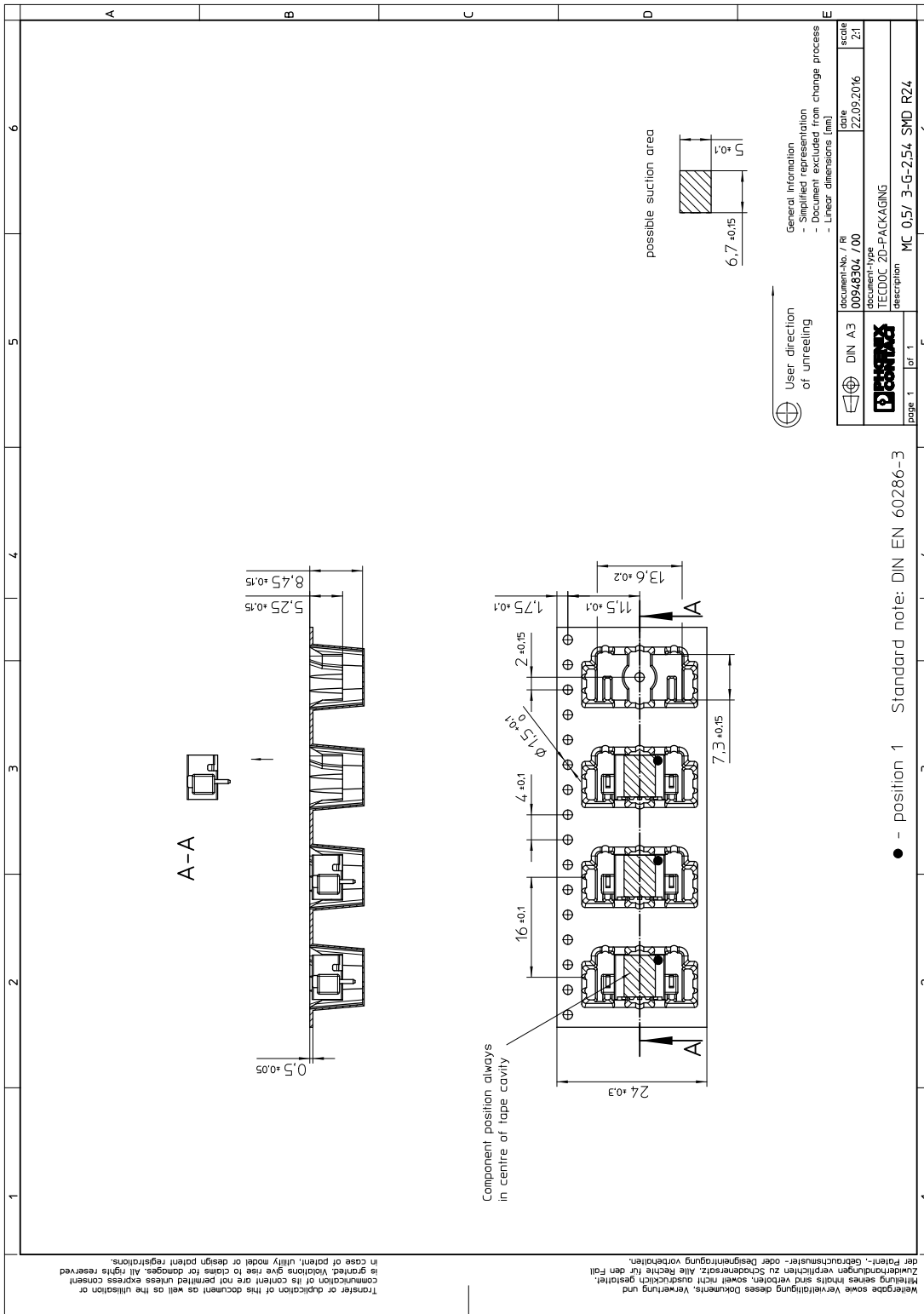

1821708 MC 0,5/ 3-G-2,54 SMD R24**12.1 Processing notes**

Process	Reflow soldering
Specification	Following IPC/JEDEC J-STD-020D.1:2008-03
Specification	Following IEC 60068-2-58:2005-02
Moisture Sensitive Level	MSL 1
Classification temperature T_c	max. 260 °C
Solder cycles in the reflow	3
swash circumference	see dimensional drawing

12.2 Temperature limit values

Ambient temperature (storage/transport)	-40 °C ... 70 °C
Ambient temperature (assembly)	-5 °C ... 100 °C
Ambient temperature (operation)	-40 °C ... 100 °C (dependent on the derating curve)

1821708 MC 0,5/ 3-G-2,54 SMD R24**13 Mechanical tests****13.1 Visual examination**

Specification	IEC 61984:2008-10
Visual examination	Test passed
Specification	IEC 60512-1-1:2002-02

13.2 Dimensional test

Dimensional test	Test passed
Specification	IEC 60512-1-2:2002-02

13.3 Resistance of marking

Resistance of marking	Test passed
Specification	IEC 60068-2-70:1995-12

13.4 Polarization and coding

Polarization and coding	Test passed
Specification	IEC 60512-13-5:2006-02
Test force	20 N

13.5 Contact retention in insert

Contact retention in insert	Test passed
Specification	IEC 60512-15-1:2008-05
Test force per pos.	20 N

1821708 MC 0,5/ 3-G-2,54 SMD R24**14 Insertion and withdrawal forces**

Insertion and withdrawal force	
Specification	Test passed
No. of cycles	100
Insertion strength per pos. approx.	2 N
Withdraw strength per pos. approx.	2 N

1821708 MC 0,5/ 3-G-2,54 SMD R24**15 Electrical tests****15.1 Electrical data**

Rated current / conductor cross section	6 A / 0.5 mm ²
Rated insulation voltage (III/2)	160 V
Rated surge voltage (III/2)	2.5 kV
Contact resistance	2.6 mΩ
Degree of pollution	2

15.2 Air and creepage distances

Component	PCB headers		
Specification	IEC 60664-1:2007-04		
Mains type	unearthed mains		
Insulating material group	IIIa		
Comparative tracking index (IEC 60112:2003-01)	CTI 175		
Rated insulation voltage	32 V	160 V	160 V
Rated surge voltage	2.5 kV	2.5 kV	2.5 kV
Degree of pollution	3	2	2
Overvoltage category	III	III	II
Minimum clearance case A (inhomogeneous field)	1.5 mm	1.5 mm	1.5 mm
Minimum value of the creepage path requirement in acc. with table	1.5 mm	1.6 mm	1.6 mm

1821708 MC 0,5/ 3-G-2,54 SMD R24**16 Current carrying capacity/derating curves**

Specification	IEC 61984:2008-10
Note	Representation based on IEC 60512-5-2:2002-02
Note	For number of positions, see diagram
Reduction factor	0.8
Conductor cross section	0.5 mm ²

Type: FMC 0,5/...-ST-2,54 with MC 0,5/...-G-2,54 SMD R..

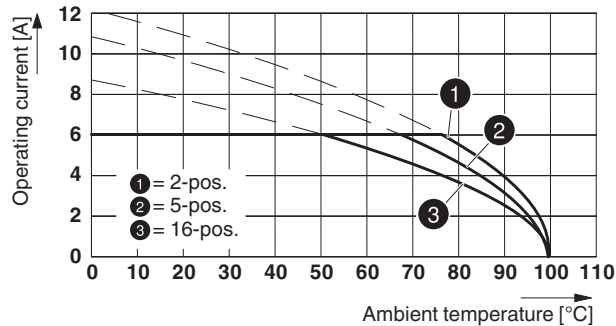



**16.1 Insulation resistance**

Specification	IEC 60512-3-1:2002-02
Result	Test passed
Insulation resistance, neighboring positions	72 TΩ

16.2 Vibration test

Specification	IEC 60068-2-6:2007-12
Result	Test passed
Frequency	10 - 500 - 10 Hz
Sweep speed	1 octave/min
Amplitude	0.35 mm (10 - 60.1 Hz)
Acceleration	5g (60.1 - 500 Hz)
Test duration per axis	2 h
Test directions	X-, Y- and Z-axis (pos. and neg.)
Note	The connected conductor loops were guided to the test sample at a distance of approx. 10 cm.

1821708 MC 0,5/ 3-G-2,54 SMD R24**17 Approvals / Certificates**

IECEE CB Scheme 	Voltage [V]	Current [A]	Cross section [AWG]	Cross section [mm ²]
	160 V	6 A	-	-
EAC 				
VDE Gutachten mit Fertigungsüberwachung 	Voltage [V]	Current [A]	Cross section [AWG]	Cross section [mm ²]
	160 V	6 A	-	-
cULus Recognized 	Voltage [V]	Current [A]	Cross section [AWG]	Cross section [mm ²]
Usegroup B	150 V	6 A	-	-
Usegroup C	50 V	6 A	-	-

1821708 MC 0,5/ 3-G-2,54 SMD R24**18 Commercial Data**

Order No.	1821708
Type	MC 0,5/ 3-G-2,54 SMD R24
Pieces per package	465
Net weight	1.391 g
GTIN	4046356789868
	Information that applies locally, see link on page 1
Country of origin	Information that applies locally, see link on page 1

19 corresponding plugs

Order No.	Type
1821106	FMC 0,5/ 3-ST-2,54

20 Accessories

Description	Order No.	Type
	0804853	SK 2,54/2,8:FORTL.ZAHLEN
	1847928	SAMPLE MC 0,5/ 3-G-2,54 SMD
	1821106	FMC 0,5/ 3-ST-2,54

1821708 MC 0,5/ 3-G-2,54 SMD R24

21 Combination tests

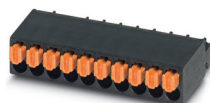
**MC 0,5/..-G-SMD**

IEC 61984

Mechanical tests (A)

Insertion/withdrawal force per position

Polarization when inserted
Requirement >20 NContact holder in insert
Requirements >20 N**Durability tests (B)**Contact resistance R_1

Insertion/withdrawal cycles

Contact resistance R_2 Rated impulse voltage at sea level
Voltage waveform $\geq (1.2/50 \mu\text{s})$ Power-frequency withstand voltage
Voltage waveform $\geq (50/60 \text{ Hz})$ **Thermal tests (C)**

Tested number of positions

Tested conductor cross section

Test current

Upper limiting temperature
Requirements < 100°C**Climatic tests (D)**

Test sequence 1: low temperature storage

Test sequence 2: heat storage

Test sequence 3: noxious gas storage
(ISO 6988)Rated impulse voltage at sea level
Voltage waveform $\geq (1.2/50 \mu\text{s})$ Power-frequency withstand voltage
Voltage waveform $\geq (50/60 \text{ Hz})$ **Environmental and endurance tests (E)**

Specification

Degree of protection

FMC 0,5/..-ST

IEC 61984

approx. 2 N / 2 N

Test passed

Test passed

2.6 m Ω

100

2.6 m Ω

2.95 kV

1.39 kV

16

0.5 mm²

6 A

Test passed

-40 °C/2 h

100 °C/168 h

1.0 dm³ SO₂ on 300 dm³/
40 °C/3 cycles

2.95 kV

1.39 kV

IEC 61984:2008-10

Back of hand safety with
IP10 access probe