

The information provided herein is from CONNELY Electronic Co., Ltd. and is confidential. Any disclosure to a party other than the recipient is prohibited. The intellectual properties and its rights contained herein, including but not limited to, trademarks, patents, copyrights, trade secrets, and technical know-how, are owned exclusively by CONNELY or its affiliates. Unauthorized use or reproduction of any part of this document is strictly prohibited. CONNELY may enforce its intellectual property rights at its own discretion, failures or delays to exercise such rights does not constitute a waiver of such rights.

REV.	DESCRIPTION	DRAWN	CHECKED	APPROVED
A	NEW RELEASE	LJC 01/16/09'		LJC 01/16/09'
B	DRAWING UPDATE	JLZ 12/07/19'		
C	DRAWING UPDATE	JLZ 01/12/23'		

Notes:

Specifications:

- Contact Resistance: 30mΩ Max.
- Insulation Resistance: 1000MΩ Min.
- Dielectric Withstanding Voltage: 500V AC(rms) For 1 Minute.
- Current Rating:1A.
- Temperature: -40°C~+105°C.

Materials:

- Contact Material: Copper Alloy.
- Contact Plating: Selective gold flash.
- Insulator Material: PBT,UL94-V0.
- Shell Material: Steel.

Product Number Code:

DS1039-01 - X X X X X

- X: Latch Support
- S: W/ Latch(For Female)
- X: W/O Latch
- : Contact plating
- 0: Selective gold flash
- 1: Selective 10u" gold
- 3: Selective 30u" gold
- : Housing color
- L: Blue
- W: White
- B: Black
- : Connector Type
- M: male
- F: female
- : No. of Positions
- 14 24 36 50

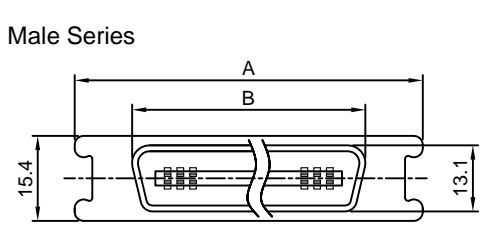

Male dimensions

Positions	A	B
14	38.5	25.6
24	54.8	36.5
36	62.0	49.4
50	77.4	64.4

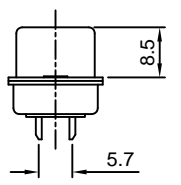
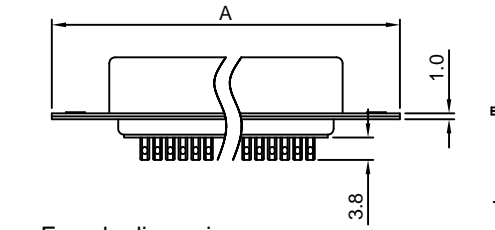
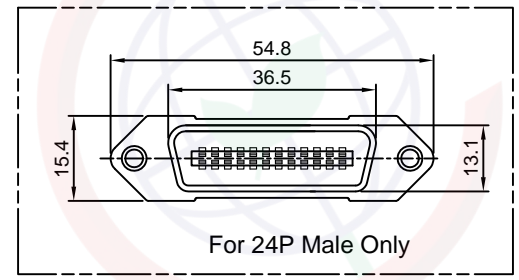
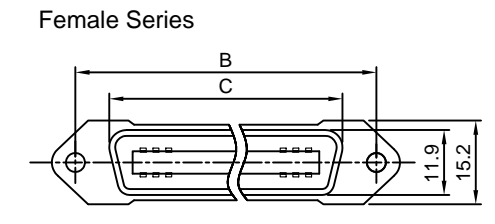
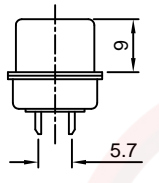
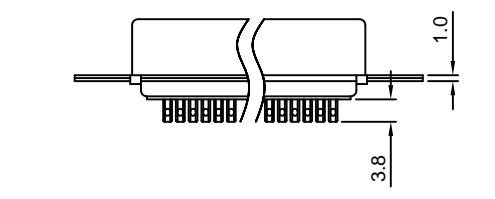

Female dimensions

Positions	A	B	C
14	43.9	36.0	25.2
24	54.7	46.8	36.0
36	67.7	59.7	48.9
50	82.8	74.9	64.1

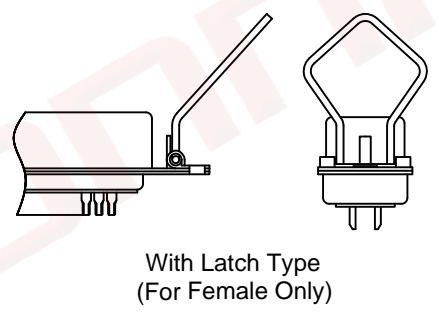

(Series Image-Reference Only)

GENERAL TOLERANCE		ANGLE TOLERANCE		PROJECTION		TITLE	
X.	±0.60	X.	±5°	UNITS	mm	Centronic Connector Solder Type	
.X	±0.38	.X	±3°	SHEET SIZE	A4	SERIES	DS1039-01 SERIES
.XX	±0.25	.XX	±2°	<b>晨翔电子有限公司</b> <b>CONNFLY CONNELY ELECTRONIC CO. LTD</b>			
DRAWING TYPE		CUSTOMER					
SCALE	1:1	SHEET	1 OF 1				
DRAWING NO.		C-DS1039-01-XXXXX-C					