

# MP and EL Industry Current Sensors

## Utilisation

Sensors to measure d.c., a.c. or pulsating currents with a galvanic insulation between primary and secondary circuits.

**Type MP25P1:** the rating (from 5 to 25A) is determined via a combination of the primary connections (see table: "Arrangement of primary terminals and related characteristics").

## Technical data

	Without primary bus bar		-	MP25P1	EL25P1	EL50P1	EL55P2	EL100P2
	With primary bus bar							
		A r.m.s.			EL25P1BB	EL50P1BB	EL55P2BB	EL100P2BB
Nominal primary current		A r.m.s.	See data page 11		25	50	50	100
Measuring range	@ ±15V (±5%)	A peak			±55	±80	±80	±145
Max. measuring resistance	@ I <sub>p</sub> max & ±15V (±5%)	Ω	216		142	78	93	29
Min. measuring resistance	@ I <sub>PN</sub> & ±15V (±5%) & 70°C	Ω	100		100	75	10	20
Min. measuring resistance	@ I <sub>PN</sub> & ±12V (±5%) & 70°C	Ω	0		0	15	0	0
Turn number			See data page 11		1000	1000	2000	2000
Secondary current at I <sub>PN</sub>		mA			25	50	25	50
Rms accuracy at I <sub>PN</sub>	-20 ... +70°C, sinus 50Hz	%	≤±0.5		≤±0.5	≤±0.5	≤±0.5	≤±0.5
Offset current	@ +25°C	mA	≤±0.1		≤±0.2	≤±0.2	≤±0.2	≤±0.2
Linearity		%	≤0.1		≤0.1	≤0.1	≤0.1	≤0.1
Thermal drift coefficient	-20 ... +70°C	µA/°C	7		7	7	7	7
Delay time		µs	≤0.1		≤0.1	≤0.1	≤0.1	≤0.1
di/dt correctly followed		A / µs	≤100		≤200	≤200	≤150	≤150
Bandwidth	-1dB	kHz	≤150		≤200	≤200	≤150	≤150
Max. no-load consumption current	@ ±15V (±5%)	mA	≤18		≤20	≤20	≤20	≤20
Secondary resistance	@ +70°C	Ω	≤96		≤63	≤63	≤188	≤126
Dielectric strength Primary/Secondary	50 Hz, 1 min	kV	2.5		3	3	3	3
Supply voltage	±5%	V dc	±12 ... ±15		±12 ... ±15	±12 ... ±15	±12 ... ±15	±12 ... ±15
Voltage drop		V	≤3		≤3	≤3	≤3	≤3
Mass (EL type)		kg	-		0.020	0.020	0.020	0.020
Mass (MP and EL...BB types)		kg	0.027		0.027	0.027	0.027	0.027
Operating temperature		°C	-20 ... +70		-20 ... +70	-20 ... +70	-20 ... +70	-20 ... +70
Storage temperature		°C	-25 ... +85		-25 ... +85	-25 ... +85	-25 ... +85	-25 ... +85

### MP25P1



### EL25P1 to 100P2 / EL25P1BB to 100P2BB



## General data

### Direction of the current:

- **MP25P1 type:** a primary current flowing from pins 1- 5 to pins 6-10 results in a positive secondary output current from terminal M.
- **EL type:** a primary current flowing in the direction of the arrow results in a positive secondary output current from terminal M.

**Secondary connection:** 3 soldering pins.

### Unit packing:

- **MP25P1 type:** 40 per pack.
- **EL type:** 50 per pack.
- **EL...BB type:** 25 per pack.

## Fixing and connecting by soldering pins

(on PCB)

### Primary connection:

- **MP25P1 type:** by 10 soldering pins.
- **EL type:** hole for primary conductor (the temperature of the primary conductor in contact with the case must not exceed 100 °C)
- **EL...BB type:** primary bar included.

# MP and EL Industry Current Sensors

## MP25P1 : Arrangement of primary terminals and related characteristics

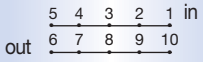
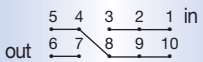
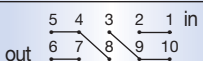
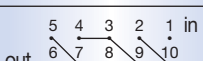
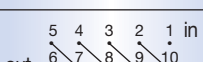
Nominal primary current (A r.m.s.)	Measuring range @ ±15V (±5%) (A peak)	Secondary current at I <sub>pn</sub> (mA)	Turn ratio (N <sub>p</sub> /N <sub>s</sub> )	Primary resistance (mΩ)	Primary pin connections
25	±36	25	1/1000	0.3	
12	±18	24	2/1000	1.1	
8	±12	24	3/1000	2.5	
6	±9	24	4/1000	4.4	
5	±7	25	5/1000	6.3	

### Dimensions (in mm)

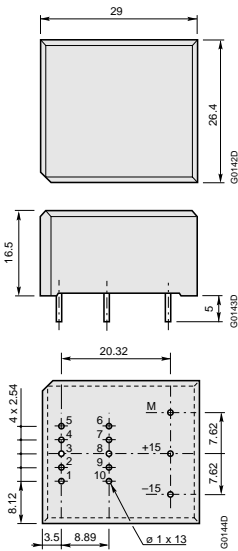

**MP current sensors**

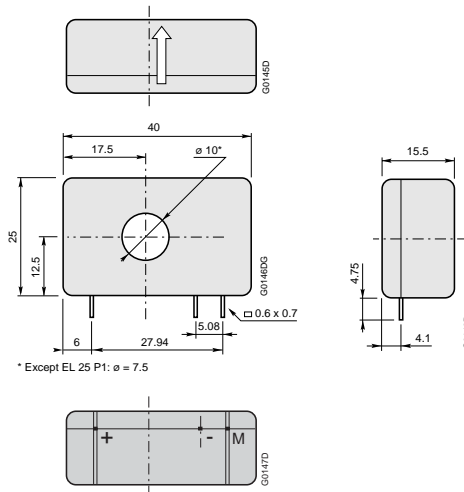

**EL current sensors**

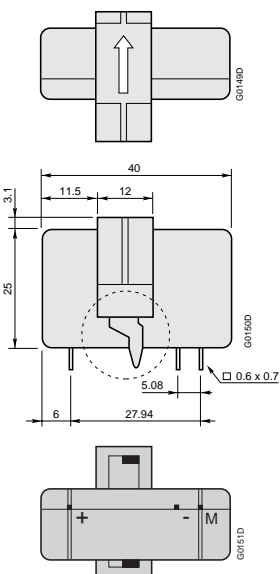

**EL...BB current sensors**

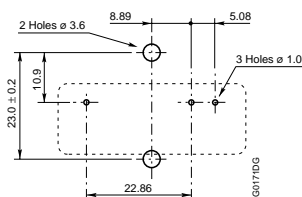
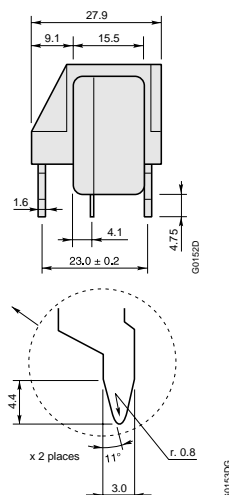

**EL...BB: PCB layout**