

ORION CR1620 3V Lithium Cell

Lithium (Li/MnO₂)

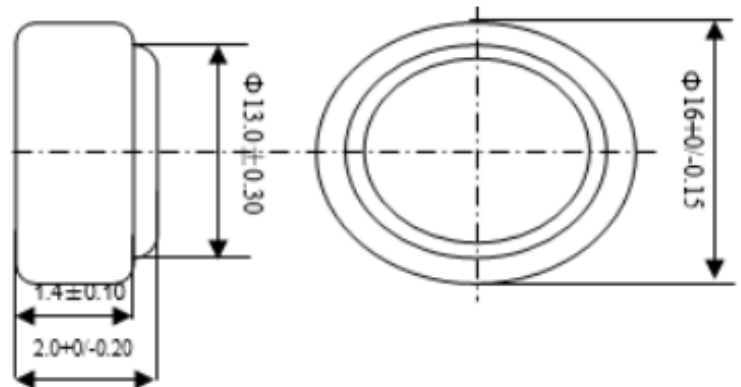

Lithium Coin Cells are small discs that are very small and very light, great for small, low-power devices. They're also fairly safe, have a long shelf life and fairly inexpensive per unit. However, they are not rechargeable and have high internal resistance so they can't provide a lot of continuous current. Do not purchase Lithium batteries before reading and understanding these safety cautions. Using a Lithium cell incorrectly may cause it to leak, generate heat, smoke, catch on fire.



SAFETY

- + The cell must stay in the operating temperatures outlined in its data sheet.
- + The cell must not exceed voltage, current, and other ratings in its data sheet.
- + Store batteries separately, and do not transport without proper packaging.
- + Never store or transport together with conductive or metallic objects particularly in a pocket or bag.
- + Do not keep in the sun, in a hot car, or anywhere with direct heat.
- + If the cell is attached to a PCB, keep it away from high-static environments.
- + Recycle discontinued batteries according to local regulations and cover terminals with insulating tape before disposal.
- + Discharge end or cut-off voltage in data sheet is lower-limit for discharge cycle and should not be exceeded.
- + Charger or device should implement warning for over-voltage, over current, and over-temperature, control of overcharge, and charge timer.
- + Be careful not to short-circuit.

TECHNICAL DATA

Cell Dimensions	16x2mm
Cell Weight	1.3g
Cell Capacity (68k Ω continuous to 2.0V)	68mAh
Voltage (nominal)	3V
Discharge Cut-off Voltage	2V
Temperature range	-20°C to 80°C
Recommended Storage Temperature	20°C \pm 5°C
Open Circuit Voltage (fresh)	3.10V ~ 3.30V
Open Circuit Voltage (after 12 months)	3.10V ~ 3.30V
Closed Current Voltage (fresh)	\geq 3.0V (load 15k Ω for 0.8s)
Closed Current Voltage (after 12 months)	\geq 3.0V (load 15k Ω for 0.8s)
Service Life (47k Ω)	\geq 630hours (cut off: 2.0V)
Service Life (47k Ω after 12 months)	\geq 560hours (cut off: 2.0V)