



健隆投資有限公司
STRONG BASE INVESTMENT LTD.

Unit 17, 11/F., Hewlett Centre, 52-54 Hoi Yuen Road, Kwun Tong, Kowloon, Hong Kong.
Tel: (852) 2793 3293 Fax: (852) 2793 3096



Approval Sheet
(確認書)

編號 Ref. No.	
日期 Issued Date	2021-10-06

公司名稱 : OZ
Company Name

產品編號 : 33B4SDA01
Part No.

產品種類 : LED-LAMP 仅供参考
Category

產品描述 : 3MM/ULTRA BRIGHT BLUE,BLUE DIFFUSED
Description

客戶產品編號 :
Customer No.

備注 :
Remarks

STRONG BASE			
ISSUER	APPROVER	CHECKER	ENGINEER
	黃志強	廖志平	馮健俊

Authorized Signature 客戶簽字				
部門 Department				
簽字 Signature				

工廠名稱:宇之亮電子(深圳)有限公司
工廠地址:廣東省深圳市龍崗區橫崗鎮荷坳村金源工業區
Company Name: Pretty Light (Shen Zhen) Limited
Factory Address:jin-Yuan,Industrial Zone He-Ao Cun,Heng-Gang
Zhen Long-Gang Area,Shen-Zhen City,
TEL: (755) 8976 7303 2869 6588 FAX: (755) 89767754 89767566

PART NO. : 33B4SDA01

DATE : 24 December 2021

3MM/ULTRA BRIGHT BLUE, BLUE DIFFUSED

SPECIFICATION

ABSOLUTE MAXIMUM RATING (Ta=25°C)

Item	Symbol	Rating	Unit
Power Dissipation	P _D	85	mW
Forward Current	I _F	20	mA
Peak Forward Current (1/10 Duty Cycle, 0.1 ms Pulse Width)	I _{FP}	100	mA
Reverse Voltage	V _R	5	V
Operating Temperature	T _{opr}	-40~+85	°C
Storage Temperature	T _{stg}	-40~+85	°C

ELECTRICAL/OPTICAL CHARACTERISTICS RATING (Ta=25°C)

Item	Symbol	Test Conditions	Rating			Unit
			Min.	Typ.	Max.	
Forward Voltage	V _F	I _F =20mA	2.7	3.1	3.6	V
Reverse Current	I _R	V _R =5V	---	---	10	μA
Luminous Intensity	I _v	I _F =20mA	---	350	---	mcd
Dominant Wave Length	λ _d	I _F =20mA	---	470	---	nm
Viewing Angle 2θ _{1/2}	2θ _{1/2}	I _F =20mA	35°			deg.

Notes:-

1) θ_{1/2} is the off-axis angle where the luminous intensity is half the optical centerline value.

Soldering Conditions : Soldering Temp. ≤ 260°C

Soldering Time ≤ 5 Sec.



Caution : ESD protection measures shall be considered and taken in the initial design stage, because static electricity and surge could damage the LED.

A wrist band or an anti-electrostatic glove should be used when handling Electrostatic Sensitive Devices.

PART NO. : 33B4SDA01

DATE : 24 December 2021

3MM/ULTRA BRIGHT BLUE, BLUE DIFFUSED

PACKAGE DIMENSION

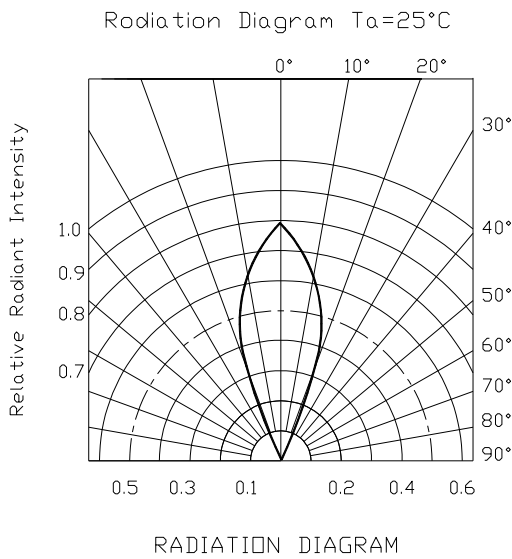

Item	Materials
Resin(Mold)	Epoxy Resin
Lead Frame	Copper Alloy

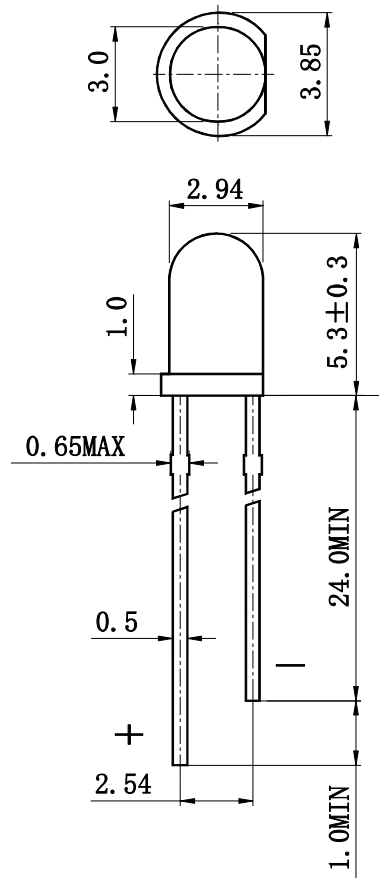

Tolerance: ± 0.25(0.01)

Unit: mm(inch)

Part Number	Emitting Color	Lens Type
33B4SDA01	BLUE	BLUE DIFFUSED

PART NO. : 33B4SDA01

DATE : 24 December 2021

3MM/ULTRA BRIGHT BLUE, BLUE DIFFUSED

Typical Electrical/Optical Characteristics Curves

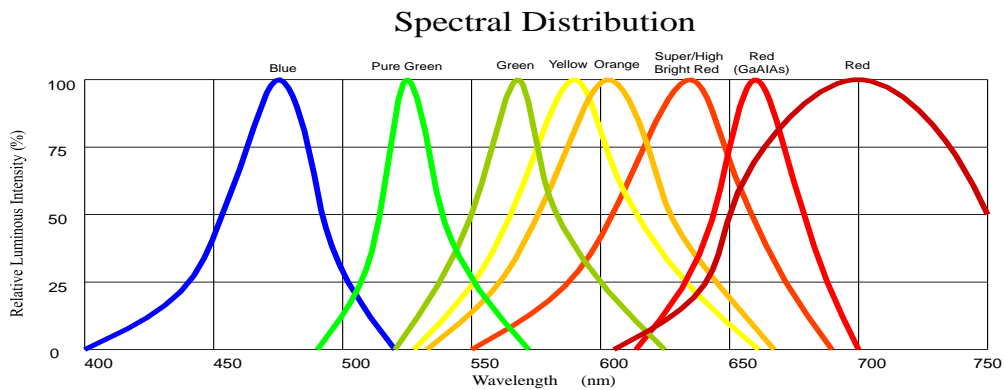

Fig1.Forward Current vs.Forward Voltage

Fig2.Relative Intensity vs. Forward Current

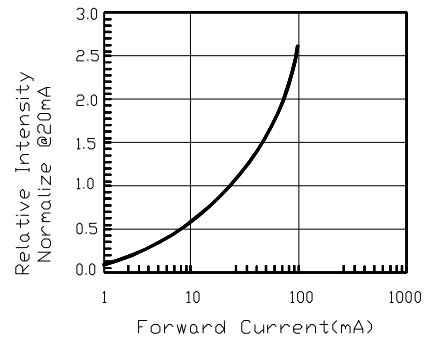
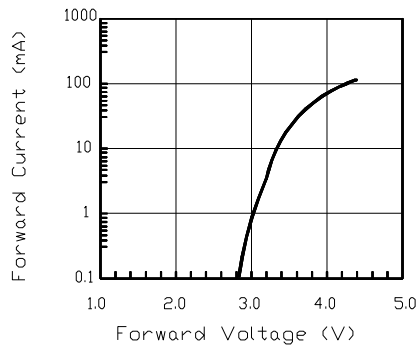
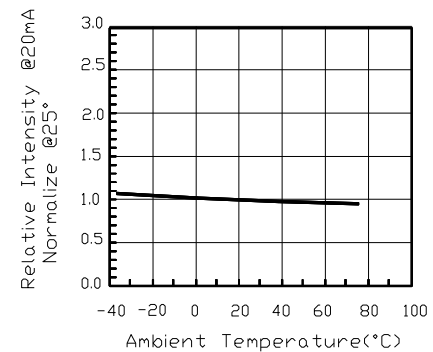
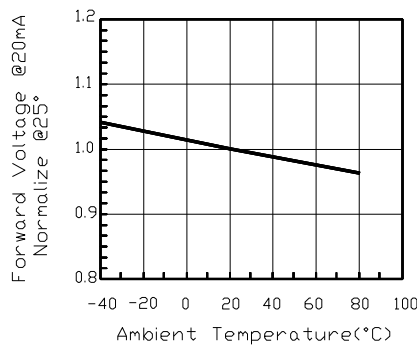

Fig3.Forward Voltage vs. Temperature

Fig4.Relative Intensity vs. Temperature



PART NO. : 33B4SDA01

DATE : 24 December 2021

3MM/ULTRA BRIGHT BLUE, BLUE DIFFUSED

LED lamp use explain

If there are 2 lights lamp use, according to the (PRETTY LIGHT) each small packaging labeled BIN to separate the use.

此产品在多颗使用时，需按照字之亮每小包上标示的 BIN 级来分开使用