

## SC 3.81/04/90G 3.2SN GN BX

**Weidmüller Interface GmbH & Co. KG**

Klingenbergstraße 26

D-32758 Detmold

Germany

www.weidmueller.com

### Product image

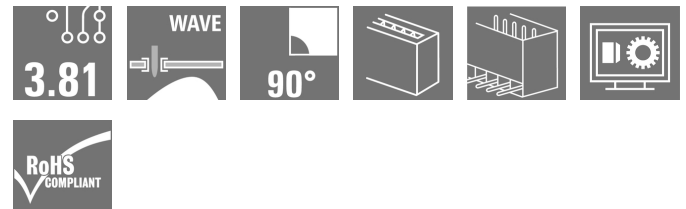

Similar to illustration

The SC pin header has a parallel (recumbent) plugging direction in relation to the PCB. It is available in closed (G) and screw flange (F) versions.

Weidmüller's 3.81-mm-pitch (0.15 inch) plug-in connectors are compatible with the layouts of standard connectors. They support a flood-light display and offer space for labelling and coding.

### General ordering data

|              |  |
|--------------|--|
| Version      | PCB plug-in connector, male header, closed side, THT solder connection, 3.81 mm, Number of poles: 4, 90°, Solder pin length (l): 3.2 mm, tinned, Pale green, Box |
| Order No.    | <a href="#">1793260000</a>   |
| Type         | SC 3.81/04/90G 3.2SN GN BX   |
| GTIN (EAN)   | 4032248227730  |
| Qty.         | 108 pc(s).   |
| Product data | IEC: 320 V / 17.5 A<br>UL: 300 V / 10 A  |
| Packaging    | Box  |

Creation date January 3, 2022 10:50:32 AM CET

**SC 3.81/04/90G 3.2SN GN BX**
**Weidmüller Interface GmbH & Co. KG**

Klingenbergstraße 26

D-32758 Detmold

Germany

www.weidmueller.com

**Technical data**
**Dimensions and weights**

|                          |            |                 |            |
|--------------------------|------------|-----------------|------------|
| Depth                    | 9.2 mm     | Depth (inches)  | 0.362 inch |
| Height                   | 10.3 mm    | Height (inches) | 0.406 inch |
| Height of lowest version | 7.1 mm     | Width           | 16.64 mm   |
| Width (inches)           | 0.655 inch | Net weight      | 0.546 g    |

**System specifications**

| Product family                               | OMNIMATE Signal - series BC/SC 3.81 | Type of connection                         | Board connection |
|--|-------------------------------------|--|------------------|
| Mounting onto the PCB                        | THT solder connection               | Pitch in mm (P)                            | 3.81 mm          |
| Pitch in inches (P)                          | 0.15 inch                           | Outgoing elbow                             | 90°              |
| Number of poles                              | 4                                   | Number of solder pins per pole             | 1                |
| Solder pin length (l)                        | 3.2 mm                              | Solder pin length tolerance                | 0 / -0.2 mm      |
| Solder pin dimensions                        | d = 1.0 mm, Octagonal               | Solder pin dimensions = d tolerance        | 0 / -0,03 mm     |
| Solder eyelet hole diameter (D)              | 1.2 mm                              | Solder eyelet hole diameter tolerance (D)+ | 0,1 mm           |
| L1 in mm                                     | 11.43 mm                            | L1 in inches                               | 0.45 inch        |
| Number of rows                               | 1                                   | Pin series quantity                        | 1                |
| Touch-safe protection acc. to DIN VDE 57 106 | Safe from finger touch              | Touch-safe protection acc. to DIN VDE 0470 | IP 20            |
| Volume resistance                            | ≤5 mΩ                               | Can be coded                               | Yes              |
| Plugging force/pole, max.                    | 7 N                                 | Pulling force/pole, max.                   | 5 N              |

**Material data**

| Insulating material                   | PA GF        | Colour                                | Pale green |
|---------------------------------------|--------------|---------------------------------------|------------|
| Colour chart (similar)                | RAL 6021     | Insulating material group             | II         |
| Comparative Tracking Index (CTI)      | ≥ 550        | UL 94 flammability rating             | V-0        |
| Contact material                      | Copper alloy | Contact surface                       | tinned     |
| Storage temperature, min.             | -40 °C       | Storage temperature, max.             | 70 °C      |
| Operating temperature, min.           | -50 °C       | Operating temperature, max.           | 120 °C     |
| Temperature range, installation, min. | -25 °C       | Temperature range, installation, max. | 120 °C     |

**Rated data acc. to IEC**

| tested acc. to standard   | IEC 60664-1, IEC 61984 | Rated current, min. number of poles (Tu=20°C)                         | 17.5 A           |
|---|------------------------|---|------------------|
| Rated current, max. number of poles (Tu=20°C)                             | 17.5 A                 | Rated current, min. number of poles (Tu=40°C)                         | 17.5 A           |
| Rated current, max. number of poles (Tu=40°C)                             | 16.3 A                 | Rated voltage for surge voltage class / pollution degree II/2         | 320 V            |
| Rated voltage for surge voltage class / pollution degree III/2            | 160 V                  | Rated voltage for surge voltage class / pollution degree III/3        | 160 V            |
| Rated impulse voltage for surge voltage class/ pollution degree II/2      | 2.5 kV                 | Rated impulse voltage for surge voltage class/ pollution degree III/2 | 2.5 kV           |
| Rated impulse voltage for surge voltage class/ contamination degree III/3 | 2.5 kV                 | Short-time withstand current resistance                               | 3 x 1s with 76 A |

**Rated data acc. to CSA**

| Rated voltage (Use group B / CSA) | 300 V | Rated current (Use group B / CSA) | 8 A |
|-----------------------------------|-------|-----------------------------------|-----|
|-----------------------------------|-------|-----------------------------------|-----|

## SC 3.81/04/90G 3.2SN GN BX

**Weidmüller Interface GmbH & Co. KG**  
 Klingenbergstraße 26  
 D-32758 Detmold  
 Germany

www.weidmueller.com

## Technical data

## Rated data acc. to UL 1059

Institute (cURus)



Certificate No. (cURus)

E60693

Rated voltage (Use group B / UL 1059) 300 V

Rated voltage (Use group D / UL 1059) 300 V

Rated current (Use group B / UL 1059) 10 A

Rated current (Use group D / UL 1059) 10 A

Reference to approval values

Specifications are maximum values, details - see approval certificate.

## Packing

|           |        |            |        |
|-----------|--------|------------|--------|
| Packaging | Box    | VPE length | 349 mm |
| VPE width | 138 mm | VPE height | 33 mm  |

## Classifications

|             |             |             |             |
|-------------|-------------|-------------|-------------|
| ETIM 6.0    | EC002637    | ETIM 7.0    | EC002637    |
| ETIM 8.0    | EC002637    | ECLASS 9.0  | 27-44-04-02 |
| ECLASS 9.1  | 27-44-04-02 | ECLASS 10.0 | 27-44-04-02 |
| ECLASS 11.0 | 27-46-02-01 |             |             |

## Important note

IPC conformity

Conformity: The products are developed, manufactured and delivered according international recognized standards and norms and comply with the assured properties in the data sheet resp. fulfill decorative properties in accordance with IPC-A-610 "Class 2". Further claims on the products can be evaluated on request.

Notes

- Additional colours on request
- P on drawing = pitch
- Rated data refer only to the component itself. Clearance and creepage distances to other components are to be designed in accordance with the relevant application standards.
- Long term storage of the product with average temperature of 50 °C and average humidity 70%, 36 months

## Approvals

Approvals



ROHS

Conform

UL File Number Search

E60693

## SC 3.81/04/90G 3.2SN GN BX

**Weidmüller Interface GmbH & Co. KG**  
Klingenbergstraße 26  
D-32758 Detmold  
Germany

[www.weidmueller.com](http://www.weidmueller.com)

# Technical data

## Downloads

|   |   |
|---|---|
| Approval/Certificate/Document of Conformity | <a href="#">Declaration of the Manufacturer</a>   |
| Engineering Data                            | <a href="#">WSCAD</a>   |
| Product Change Notification                 | <a href="#">Change of packaging - DE</a><br><a href="#">Change of packaging - EN</a>  |
| Catalogues                                  | <a href="#">Catalogues in PDF-format</a>  |
| Brochures                                   | <a href="#">FL DRIVES EN</a><br><a href="#">MB DEVICE MANUF. EN</a><br><a href="#">FL DRIVES DE</a><br><a href="#">FL BUILDING SAFETY EN</a><br><a href="#">FL APPL LED LIGHTING EN</a><br><a href="#">FLIndustr.CONTROLS EN</a><br><a href="#">FL MACHINE SAFETY EN</a><br><a href="#">FL HEATING ELECTR EN</a><br><a href="#">FL APPL INVERTER EN</a><br><a href="#">FL_BASE_STATION_EN</a><br><a href="#">FL ELEVATOR EN</a><br><a href="#">FL POWER SUPPLY EN</a><br><a href="#">FL 72H SAMPLE SER EN</a><br><a href="#">PO OMNIMATE EN</a> |

**SC 3.81/04/90G 3.2SN GN BX**

**Weidmüller Interface GmbH & Co. KG**  
Klingenbergstraße 26  
D-32758 Detmold  
Germany

[www.weidmueller.com](http://www.weidmueller.com)

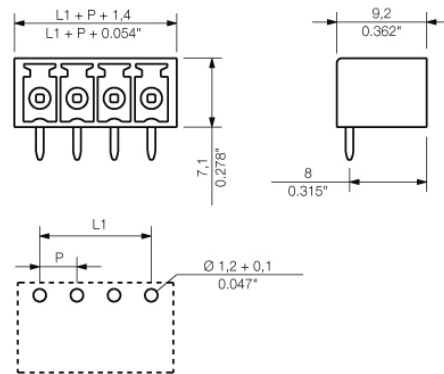
**Dimensional drawing**

08

SC 3.81/.../90G 3.2....

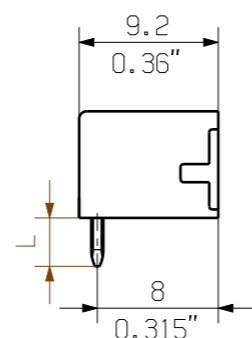
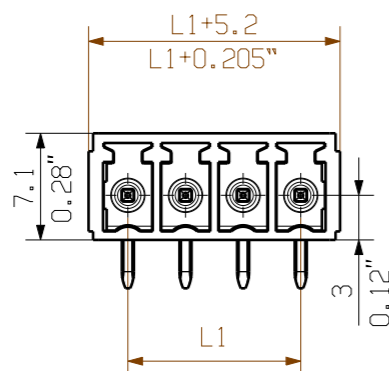

SC 3.81/.../90F 3.2...

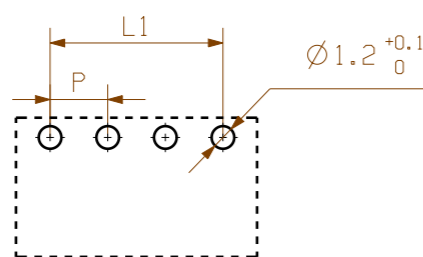
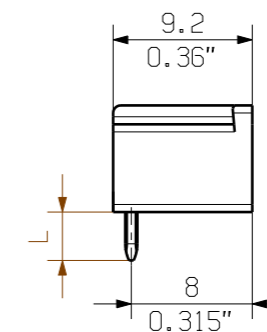
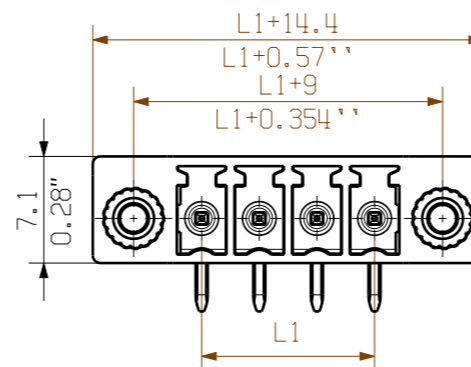

PCB LAYOUT

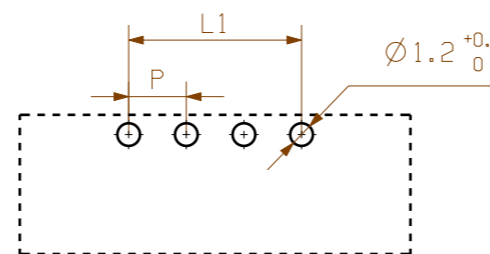

PCB LAYOUT

KUNDENZEICHUNG  
CUSTOMER DRAWING

P=3.81

|    |         |           |
|----|---------|-----------|
| 20 | 72.39   | 2.850     |
| 19 | 68.58   | 2.700     |
| 18 | 64.77   | 2.550     |
| 17 | 60.96   | 2.400     |
| 16 | 57.15   | 2.250     |
| 15 | 53.34   | 2.100     |
| 14 | 49.53   | 1.950     |
| 13 | 45.72   | 1.800     |
| 12 | 41.91   | 1.650     |
| 11 | 38.10   | 1.500     |
| 10 | 34.29   | 1.350     |
| 9  | 30.48   | 1.200     |
| 8  | 26.67   | 1.050     |
| 7  | 22.86   | 0.900     |
| 6  | 19.05   | 0.750     |
| 5  | 15.24   | 0.600     |
| 4  | 11.43   | 0.450     |
| 3  | 7.62    | 0.300     |
| 2  | 3.81    | 0.150     |
| N  | L1 [mm] | L1 [inch] |

For the mounting of PCBs, it should be noted that the rated data given in the catalogue relates only to the connection elements. The necessary creepage and clearance paths must be observed in connection with the respective applicant in accordance to VDE 0110. The current-carrying capacity and pitch tolerance is to be determined according to DIN IEC 326 part 3 very fine.

Weidmüller connectors are tested to the DIN VDE 0627 standard, and are valid for its field of application. Provided that the connectors are used to the intended purpose, all requirements with respect to the occurring of electrical, mechanical, thermic and corrosive stress will be satisfied.

|   |   |   |  |          |                                     |
|---|---|---|--|----------|-------------------------------------|
| <b>GENERAL TOLERANCE:</b><br>DIN ISO 2768-m |   | 97482/0<br>06.09.17 MA_J 01   |  | Cat.no.: |                                     |
| RoHS COMPLIANT<br>Max. nos.                 | Modification  |   | <b>Weidmüller</b>  |          | C 40384 08<br>Drawing no. Issue no. |
| Scale: 5/1<br>Supersedes:                   | Drawn: 09.02.2006<br>Responsible: MA_J<br>Checked: 13.09.2017<br>Approved: XU_S | Date: 09.02.2006<br>Name: ZHANG_H<br>Name: MA_J<br>Name: ZHOU_N<br>Name: XU_S | SC 3.81/.../90...3.2...<br>ANSCHLUSS STIFTLAISTE<br>PIN HEADER |          |                                     |
| Product file: SC 3.81                       |   |   | Sheet 01 of 02 sheets  |          |                                     |
|   |   |   |  |          | 7069                                |

The reproduction, distribution and utilization of this document as well as the communication of its contents to others without explicit authorization is prohibited. Offenders will be held liable for the payment of damages. Weidmüller exclusively reserves the right to file for patents, utility models or designs.

© Weidmüller Interface GmbH & Co. KG

## Recommended wave soldering profiles

**Weidmüller Interface GmbH & Co. KG**  
 Klängenbergstraße 16  
 D-32758 Detmold  
 Germany  
 Fon: +49 5231 14-0  
 Fax: +49 5231 14-292083  
 www.weidmueller.com

### Single Wave:



### Double Wave:



### Wave soldering profiles

Wired connection elements should be processed in accordance with the DIN EN 61760-1 standard. We have included two recommendations for practical wave soldering profiles, with which Weidmüller PCB terminals and connectors are qualified.

When choosing a suitable profile for your application, the following factors also need to be considered:

- PCB thickness
- Proportion of Cu in the layers
- Single/double-sided assembly
- Product range
- Heating and cooling rates

The single and double wave profiles each indicate the recommended operating range, including the maximum soldering temperature of 260°C. In practice, the maximum soldering temperature is quite often well below the above maximum profile.