

TRIAC(Through Hole / Isolated)

TMG12CQ60F 5

(Tj=150°C)

SanRex Triac TMG12CQ60F 5 is designed for full wave AC control applications. It can be used as an ON/OFF function or for phase control operation.

Typical Applications

- Home Appliances : Washing Machines, Vacuum Cleaners, Rice Cookers, Micro Wave Ovens, Hair Dryers, other control applications
- Industrial Use : SMPS, Copier Machines, Motor Controls, Dimmer, SSR, Heater Controls, Vending Machines, other control applications

Features

- I_{T(RMS)}=12A
- High Surge Current
- Low Voltage Drop

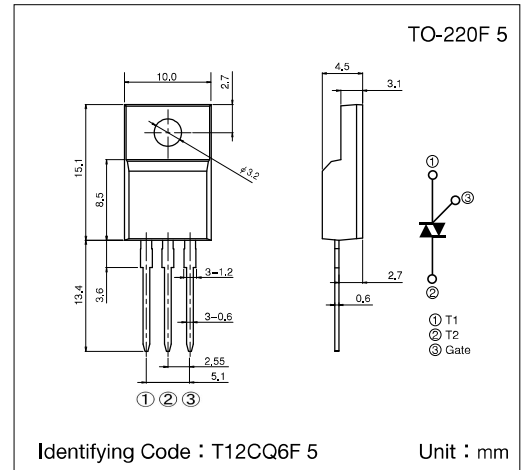

Maximum Ratings

(Tj=25°C unless otherwise specified)

Symbol	Item	Reference	Ratings	Unit
V _{DRM}	Repetitive Peak Off-State Voltage		600	V
I _{T(RMS)}	R.M.S. On-State Current	T _c =107°C	12	A
I _{TSM}	Surge On-State Current	One cycle, 50Hz/60Hz, Peak value, non-repetitive	119/130	A
I ² t	I ² t (for fusing)		71	A ² s
P _{GM}	Peak Gate Power Dissipation		5	W
P _{G(AV)}	Average Gate Power Dissipation		0.5	W
I _{GM}	Peak Gate Current		2	A
V _{GM}	Peak Gate Voltage		10	V
V _{ISO}	Isolation Breakdown Voltage (R.M.S.)	A.C. 1minute	1500	V
T _j	Operating Junction Temperature		-40~+150	°C
T _{stg}	Storage Temperature		-40~+150	°C
	Mass		2	g

Electrical Characteristics

Symbol	Item	Reference	Ratings			Unit
			Min.	Typ.	Max.	
I _{DRM}	Repetitive Peak Off-State Current	V _D =V _{DRM} , Single phase, half wave, T _j =150°C			2	mA
V _{TM}	Peak On-State Voltage	I _T =20A, Inst. measurement			1.4	V
I _{GT1} ⁺	Gate Trigger Current	V _D =6V, R _L =10Ω			30	mA
I _{GT1} ⁻					30	
I _{GT3} ⁺					—	
I _{GT3} ⁻					30	
V _{GT1} ⁺	Gate Trigger Voltage				1.5	V
V _{GT1} ⁻					1.5	
V _{GT3} ⁺					—	
V _{GT3} ⁻					1.5	
V _{GD}	Non-Trigger Gate Voltage	T _j =150°C, V _D =1/2V _{DRM}	0.1			V
(dv/dt) _c	Critical Rate of Rise of Off-State Voltage at Commutation	T _j =150°C, (di/dt) _c =-6A/ms, V _D =2/3V _{DRM}	5			V/μs
I _H	Holding Current			20		mA
R _{th}	Thermal Resistance	Junction to case			3.3	°C/W

Trigger mode of the triac

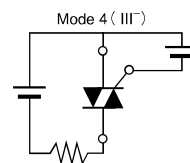
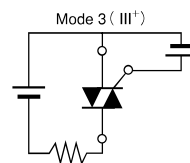
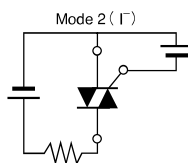
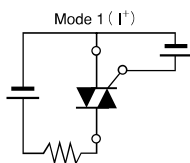

Gate Characteristics

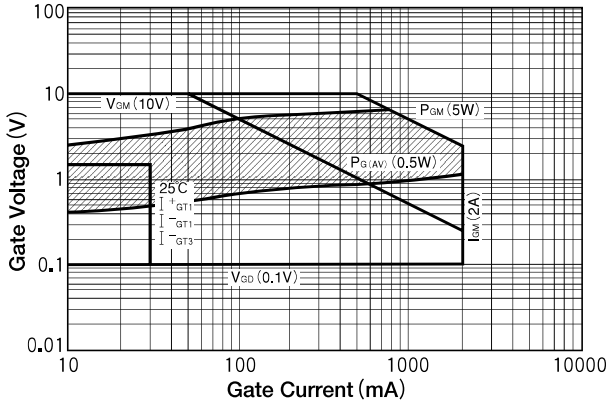

On-State Characteristics (MAX)

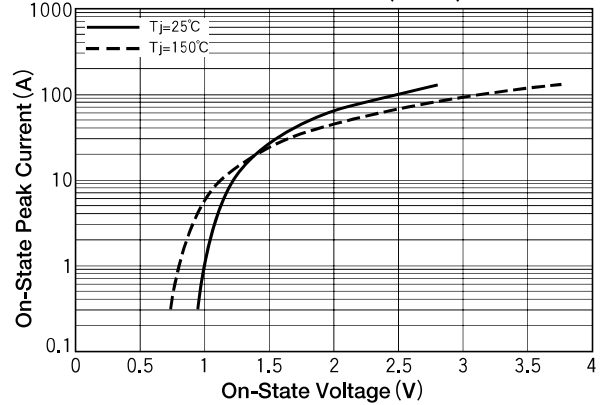

R.M.S. On-State Current vs Maximum Power Dissipation

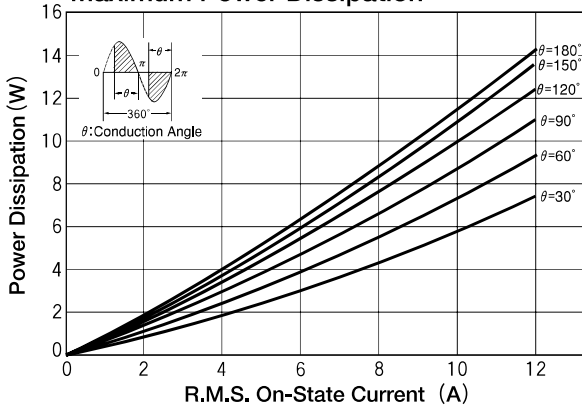

R.M.S. On-State Current vs Allowable Case Temperature

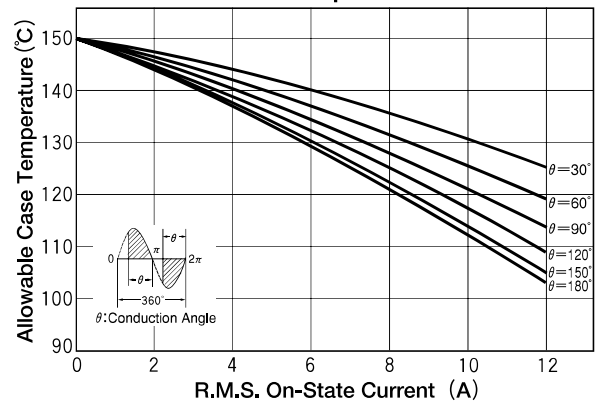

Surge On-State Current Rating (Non-Repetitive)

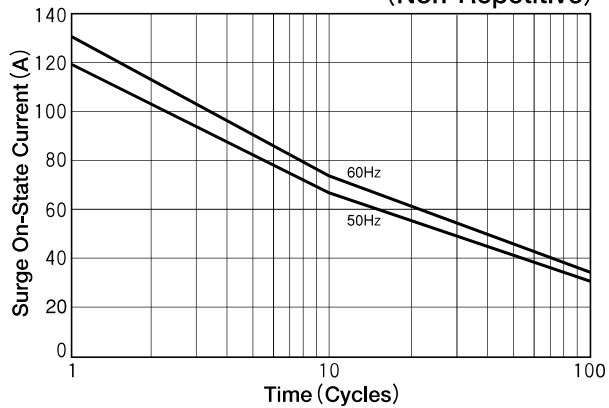

Transient Thermal Impedance

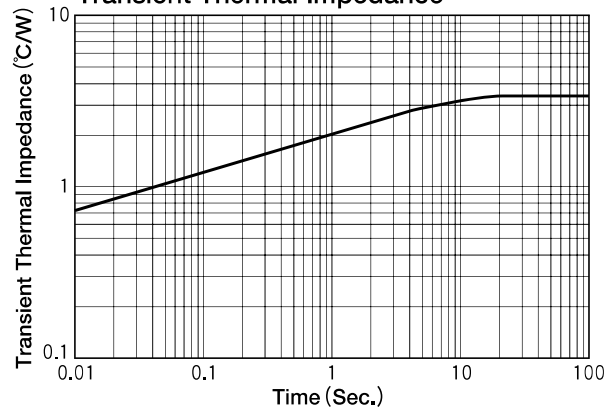

I_{GT} - T_j (Typical)

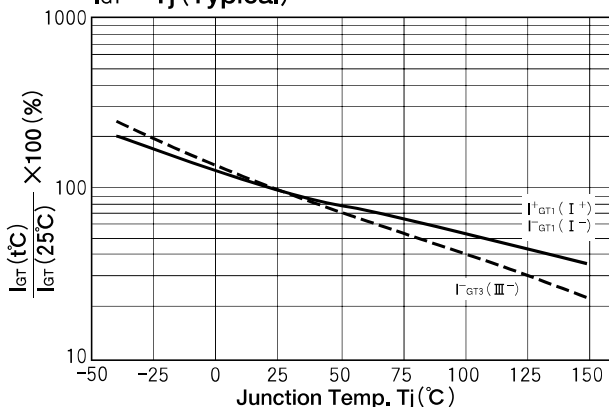

V_{GT} - T_j (Typical)

