

Optocoupler, Phototransistor Output, (Dual, Quad Channel), 110 °C Rated

Dual Channel

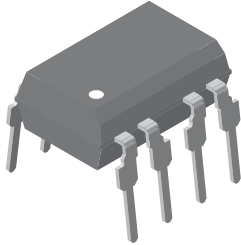

Quad Channel

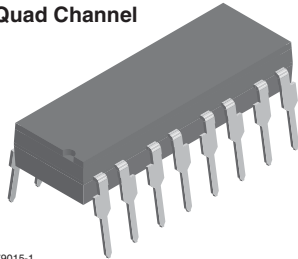

1179015-1

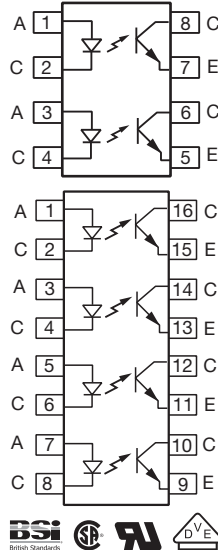

FEATURES

- Operating temperature from - 55 °C to + 110 °C
- Identical channel to channel footprint
- Dual and quad packages feature:
 - Reduced board space
 - Lower pin and parts count
 - Better channel to channel CTR match
 - Improved common mode rejection
- Isolation test voltage, 5300 V_{RMS}
- Compliant to RoHS Directive 2002/95/EC and in accordance to WEEE 2002/96/EC



RoHS COMPLIANT

AGENCY APPROVALS

- UL1577, file no. E52744 system code H, double protection
- CSA 93751
- BSI IEC 60950; IEC 60065
- DIN EN 60747-5-2 (VDE 0884)/DIN EN 60747-5-5 pending

DESCRIPTION

The ILD1615, ILQ1615 are multi-channel 110 °C rated phototransistor optocouplers that use GaAs IRLED emitters and high gain NPN phototransistors. These devices are constructed using over/under leadframe optical coupling and double molded insulation technology resulting a withstand test voltage of 7500 V_{AC PEAK} and a working voltage of 1700 V_{RMS}.

The binned min./max. and linear CTR characteristics make these devices well suited for DC or AC voltage detection. Eliminating the phototransistor base connection provides added electrical noise immunity from the transients found in many industrial control environments.

Because of guaranteed maximum non-saturated and saturated switching characteristics, the ILD1615, ILQ1615 can be used in medium speed data I/O and control systems. The binned min./max. CTR specification allow easy worst case interface calculations for both level detection and switching applications. Interfacing with a CMOS logic is enhanced by the guaranteed CTR at I_F = 1.0 mA.

ORDERING INFORMATION			
<div style="display: flex; justify-content: space-around; align-items: center;"> <div style="border: 1px solid black; padding: 2px 5px;">I</div> <div style="border: 1px solid black; padding: 2px 5px;">L</div> <div style="border: 1px solid black; padding: 2px 5px;">x</div> <div style="border: 1px solid black; padding: 2px 5px;">1</div> <div style="border: 1px solid black; padding: 2px 5px;">6</div> <div style="border: 1px solid black; padding: 2px 5px;">1</div> <div style="border: 1px solid black; padding: 2px 5px;">5</div> <div style="border: 1px solid black; padding: 2px 5px;">-</div> <div style="border: 1px solid black; padding: 2px 5px;">4</div> </div> <p style="text-align: center;">PART NUMBER x = D (Dual) or Q (Quad)</p>	CTR BIN		
AGENCY CERTIFIED/PACKAGE	DUAL CHANNEL	QUAD CHANNEL	
	CTR (%)		
UL, CSA, BSI	160 to 320	160 to 320	
DIP-8	ILD1615-4	-	
DIP-16	-	ILQ1615-4	

ILD1615, ILQ1615



Vishay Semiconductors Optocoupler, Phototransistor Output,
(Dual, Quad Channel), 110 °C Rated

ABSOLUTE MAXIMUM RATINGS ($T_{amb} = 25\text{ °C}$, unless otherwise specified)				
PARAMETER	TEST CONDITION	SYMBOL	VALUE	UNIT
INPUT				
Peak reverse voltage		V_R	6.0	V
Forward current		I_F	60	mA
Surge current		I_{FSM}	1.5	A
Power dissipation		P_{diss}	100	mW
Derate linearly from 25 °C			1.0	mW/°C
OUTPUT				
Collector emitter breakdown voltage		BV_{CEO}	70	V
Emitter collector breakdown voltage		BV_{ECO}	7.0	V
Collector current		I_C	50	mA
	$t < 1.0\text{ ms}$	I_C	100	mA
Power dissipation		P_{diss}	150	mW
Derate linearly from 25 °C			1.5	mW/°C
COUPLER				
Storage temperature		T_{stg}	- 55 to + 150	°C
Operating temperature		T_{amb}	- 55 to + 110	°C
Soldering temperature ⁽¹⁾	2.0 mm distance from case bottom	T_{sld}	260	°C
Package power dissipation ILD1615			400	mW
Derate linearly from 25 °C			5.33	mW/°C
Package power dissipation ILQ1615			500	mW
Derate linearly from 25 °C			6.67	mW/°C
Isolation test voltage	$t = 1.0\text{ s}$	V_{ISO}	5300	V_{RMS}
Creepage distance			≥ 7.0	mm
Clearance distance			≥ 7.0	mm
Isolation resistance	$V_{IO} = 500\text{ V}, T_{amb} = 25\text{ °C}$	R_{IO}	$\geq 10^{12}$	Ω
	$V_{IO} = 500\text{ V}, T_{amb} = 100\text{ °C}$	R_{IO}	$\geq 10^{11}$	Ω

Notes

- Stresses in excess of the absolute maximum ratings can cause permanent damage to the device. Functional operation of the device is not implied at these or any other conditions in excess of those given in the operational sections of this document. Exposure to absolute maximum ratings for extended periods of the time can adversely affect reliability.

⁽¹⁾ Refer to wave profile for soldering conditions for through hole devices.

ELECTRICAL CHARACTERISTICS ($T_{amb} = 25\text{ °C}$, unless otherwise specified)						
PARAMETER	TEST CONDITION	SYMBOL	MIN.	TYP.	MAX.	UNIT
INPUT						
Forward voltage	$I_F = 10\text{ mA}$	V_F	1.0	1.15	1.3	V
Breakdown voltage	$I_R = 10\text{ }\mu\text{A}$	V_{BR}	6.0	30		V
Reverse current	$V_R = 6.0\text{ V}$	I_R		0.01	10	μA
Capacitance	$V_R = 0\text{ V}, f = 1.0\text{ MHz}$	C_O		25		pF
OUTPUT						
Collector emitter capacitance	$V_{CE} = 5.0\text{ V}, f = 1.0\text{ MHz}$	C_{CE}		6.8		pF
Collector emitter leakage current	$V_{CE} = 10\text{ V}$	I_{CEO}		5.0	100	nA
Collector emitter breakdown voltage	$I_{CE} = 0.5\text{ mA}$	BV_{CEO}	70			V
Emitter collector breakdown voltage	$I_E = 0.1\text{ mA}$	BV_{ECO}	7.0			V
PACKAGE TRANSFER CHARACTERISTICS						
Channel/channel CTR match	$I_F = 10\text{ mA}, V_{CE} = 5.0\text{ V}$	CTR _X /CTR _Y	1 to 1		2 to 1	
COUPLER						
Capacitance (input to output)	$V_{IO} = 0\text{ V}, f = 1.0\text{ MHz}$	C_{IO}		0.8		pF
Insulation resistance	$V_{IO} = 500\text{ V}, T_A = 25\text{ °C}$	R_S	10^{12}	10^{14}		Ω
Channel to channel isolation			500			V_{AC}

Note

- Minimum and maximum values are tested requirements. Typical values are characteristics of the device and are the result of engineering evaluations. Typical values are for information only and are not part of the testing requirements.



CURRENT TRANSFER RATIO ($T_{amb} = 25\text{ }^{\circ}\text{C}$, unless otherwise specified)							
PARAMETER	TEST CONDITION	PART	SYMBOL	MIN.	TYP.	MAX.	UNIT
Current transfer ratio (collector emitter saturated)	$I_F = 1.0\text{ mA}$, $V_{CE} = 0.4\text{ V}$	ILD1615-4	CTR_{CEsat}		100		%
		ILQ1615-4					
Current transfer ratio (collector emitter)	$I_F = 10\text{ mA}$, $V_{CE} = 5.0\text{ V}$	ILD1615-4	CTR_{CE}	160	200	320	%
		ILQ1615-4					
	$I_F = 1.0\text{ mA}$, $V_{CE} = 5.0\text{ V}$	ILD1615-4	CTR_{CE}	56	90		%
	ILQ1615-4						

SWITCHING CHARACTERISTICS ($T_{amb} = 25\text{ }^{\circ}\text{C}$, unless otherwise specified)							
PARAMETER	TEST CONDITION	PART	SYMBOL	MIN.	TYP.	MAX.	UNIT
NON-SATURATED							
Turn-on time	$I_F = 10\text{ mA}$, $V_{CC} = 5.0\text{ V}$, $R_L = 75\text{ }\Omega$, 50 % of V_{PP}		t_{on}		3.0		μs
Rise time	$I_F = 10\text{ mA}$, $V_{CC} = 5.0\text{ V}$, $R_L = 75\text{ }\Omega$, 50 % of V_{PP}		t_r		2.0		μs
Turn-off time	$I_F = 10\text{ mA}$, $V_{CC} = 5.0\text{ V}$, $R_L = 75\text{ }\Omega$, 50 % of V_{PP}		t_{off}		2.3		μs
Fall time	$I_F = 10\text{ mA}$, $V_{CC} = 5.0\text{ V}$, $R_L = 75\text{ }\Omega$, 50 % of V_{PP}		t_f		2.0		μs
Propagation H to L	$I_F = 10\text{ mA}$, $V_{CC} = 5.0\text{ V}$, $R_L = 75\text{ }\Omega$, 50 % of V_{PP}		t_{PHL}		1.1		μs
Propagation L to H	$I_F = 10\text{ mA}$, $V_{CC} = 5.0\text{ V}$, $R_L = 75\text{ }\Omega$, 50 % of V_{PP}		t_{PLH}		2.5		μs
SATURATED							
Turn-on time	$I_F = 5.0\text{ mA}$, $V_{CC} = 5.0\text{ V}$, $R_L = 1.0\text{ k}\Omega$, $V_{HT} = 1.5\text{ V}$		t_{on}		6.0		μs
Rise time	$I_F = 5.0\text{ mA}$, $V_{CC} = 5.0\text{ V}$, $R_L = 1.0\text{ k}\Omega$, $V_{HT} = 1.5\text{ V}$		t_r		4.6		μs
Turn-off time	$I_F = 5.0\text{ mA}$, $V_{CC} = 5.0\text{ V}$, $R_L = 1.0\text{ k}\Omega$, $V_{HT} = 1.5\text{ V}$		t_{off}		25		μs
Fall time	$I_F = 5.0\text{ mA}$, $V_{CC} = 5.0\text{ V}$, $R_L = 1.0\text{ k}\Omega$, $V_{HT} = 1.5\text{ V}$		t_f		15		μs
Propagation H to L	$I_F = 5.0\text{ mA}$, $V_{CC} = 5.0\text{ V}$, $R_L = 1.0\text{ k}\Omega$, $V_{HT} = 1.5\text{ V}$		t_{PHL}		5.4		μs
Propagation L to H	$I_F = 5.0\text{ mA}$, $V_{CC} = 5.0\text{ V}$, $R_L = 1.0\text{ k}\Omega$, $V_{HT} = 1.5\text{ V}$		t_{PLH}		7.4		μs

COMMON MODE TRANSIENT IMMUNITY ($T_{amb} = 25\text{ }^{\circ}\text{C}$, unless otherwise specified)							
PARAMETER	TEST CONDITION	SYMBOL	MIN.	TYP.	MAX.	UNIT	
Common mode rejection output high	$V_{CM} = 50\text{ V}_{P-P}$, $R_L = 1.0\text{ k}\Omega$, $I_F = 0\text{ mA}$	CM_H		5000		V/ μs	
Common mode rejection output low	$V_{CM} = 50\text{ V}_{P-P}$, $R_L = 1.0\text{ k}\Omega$, $I_F = 10\text{ mA}$	CM_L		5000		V/ μs	
Common mode coupling capacitance		C_{CM}		0.01		pF	

ILD1615, ILQ1615



Vishay Semiconductors Optocoupler, Phototransistor Output,
(Dual, Quad Channel), 110 °C Rated

TYPICAL CHARACTERISTICS ($T_{amb} = 25\text{ }^{\circ}\text{C}$, unless otherwise specified)

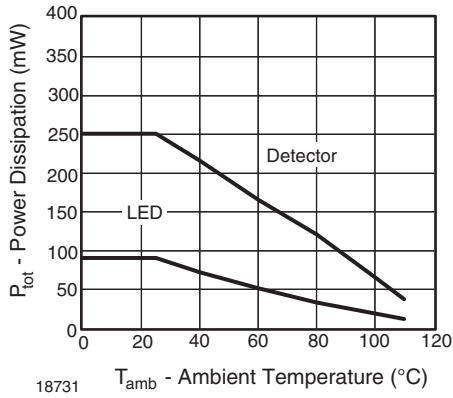

Fig. 1 - Permissible Power Dissipation vs. Temperature Non-Saturation Operation

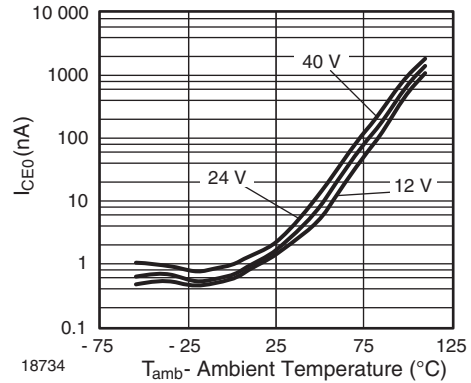

Fig. 4 - Collector to Emitter Dark Current vs. Ambient Temperature

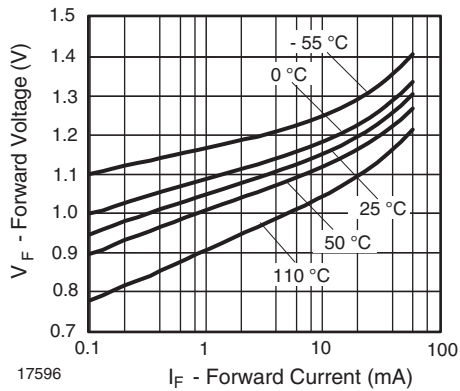

Fig. 2 - Forward Voltage vs. Forward Current

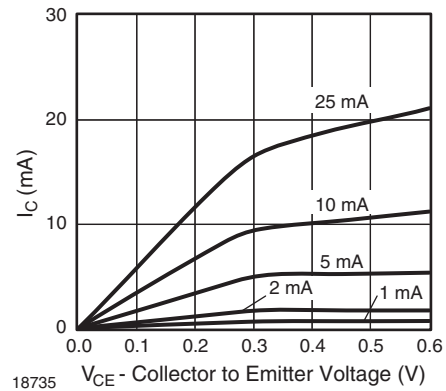

Fig. 5 - Normalized Current vs. Collector Emitter Saturation Voltage

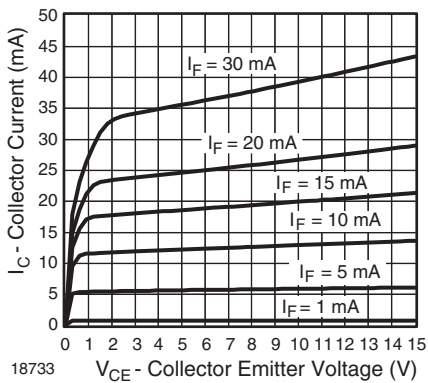

Fig. 3 - Collector Current vs. Collector Emitter Voltage

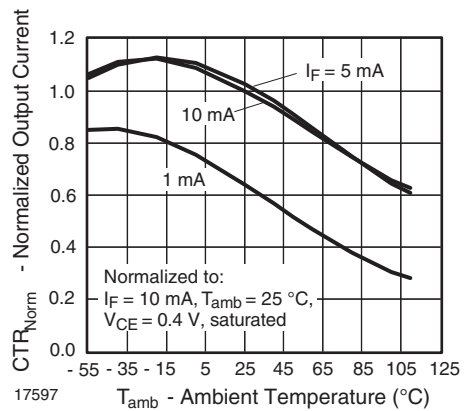

Fig. 6 - Normalized Current Transfer Ratio vs. Ambient Temperature

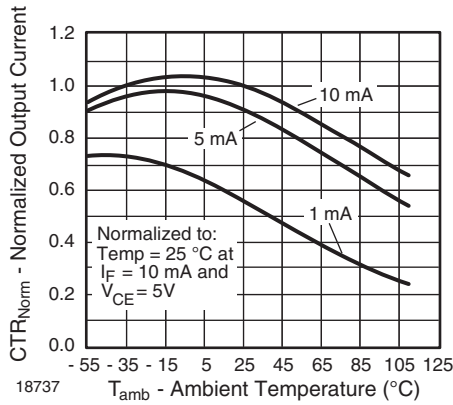

Fig. 7 - Normalized CTR vs. Temperature

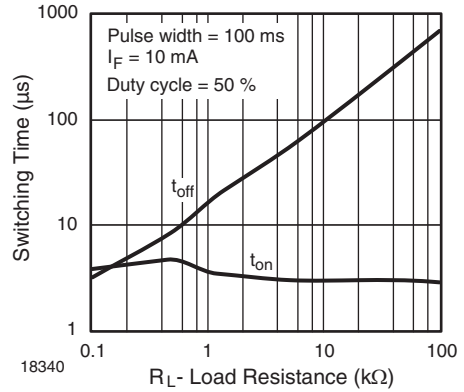

Fig. 10 - Forward Resistance vs. Forward Current

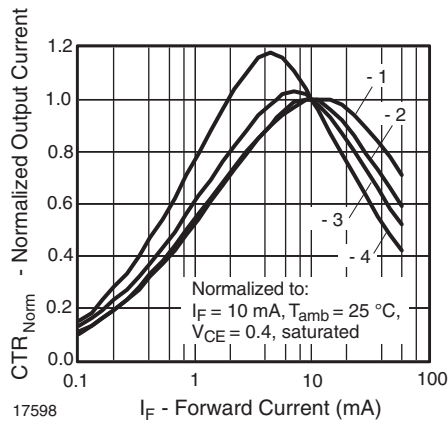

Fig. 8 - Normalized CTR vs. Forward Current

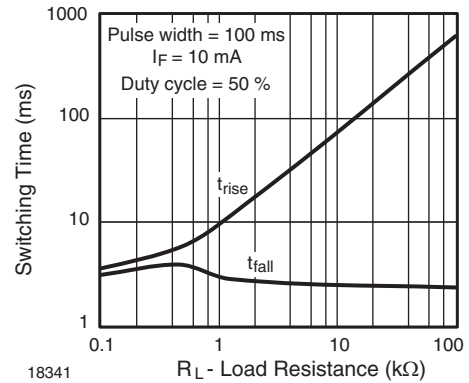

Fig. 11 - Forward Resistance vs. Forward Current

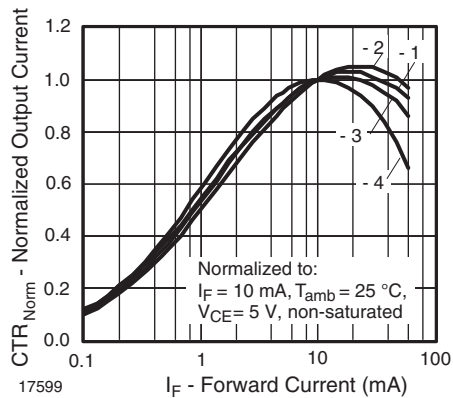

Fig. 9 - Normalized CTR vs. Forward Current

ILD1615, ILQ1615



Vishay Semiconductors Optocoupler, Phototransistor Output,
(Dual, Quad Channel), 110 °C Rated

PACKAGE DIMENSIONS in millimeters

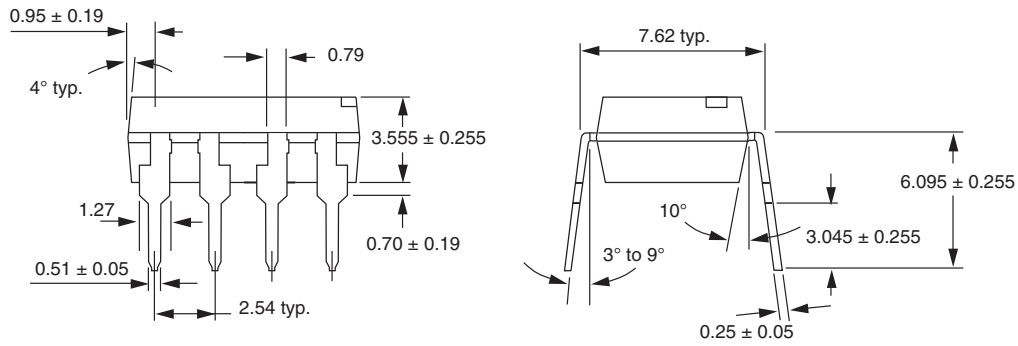
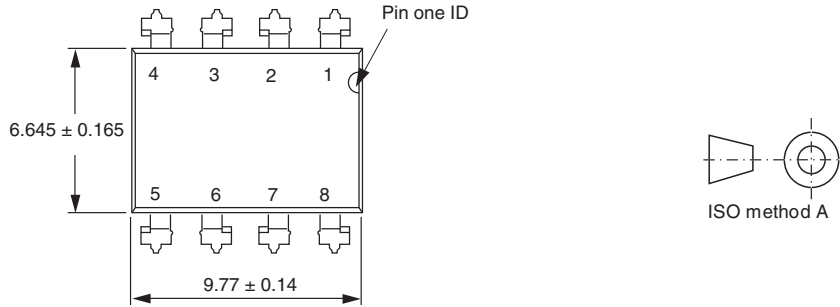

i178006

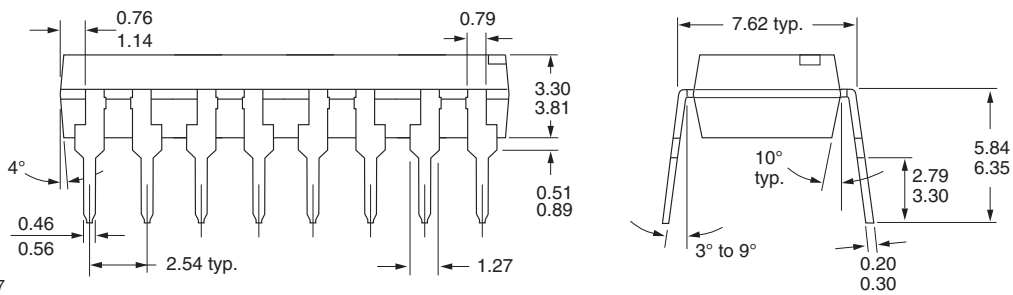
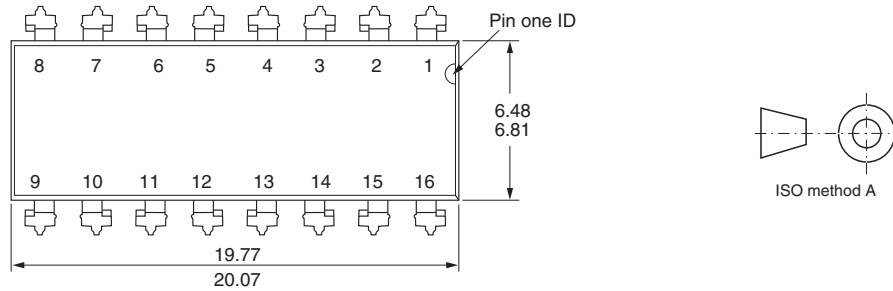

i178007

PACKAGE MARKING

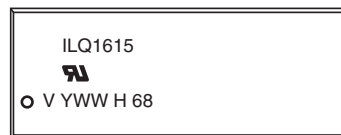
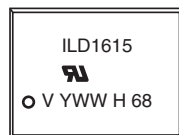



Disclaimer

ALL PRODUCT, PRODUCT SPECIFICATIONS AND DATA ARE SUBJECT TO CHANGE WITHOUT NOTICE TO IMPROVE RELIABILITY, FUNCTION OR DESIGN OR OTHERWISE.

Vishay Intertechnology, Inc., its affiliates, agents, and employees, and all persons acting on its or their behalf (collectively, "Vishay"), disclaim any and all liability for any errors, inaccuracies or incompleteness contained in any datasheet or in any other disclosure relating to any product.

Vishay makes no warranty, representation or guarantee regarding the suitability of the products for any particular purpose or the continuing production of any product. To the maximum extent permitted by applicable law, Vishay disclaims (i) any and all liability arising out of the application or use of any product, (ii) any and all liability, including without limitation special, consequential or incidental damages, and (iii) any and all implied warranties, including warranties of fitness for particular purpose, non-infringement and merchantability.

Statements regarding the suitability of products for certain types of applications are based on Vishay's knowledge of typical requirements that are often placed on Vishay products in generic applications. Such statements are not binding statements about the suitability of products for a particular application. It is the customer's responsibility to validate that a particular product with the properties described in the product specification is suitable for use in a particular application. Parameters provided in datasheets and / or specifications may vary in different applications and performance may vary over time. All operating parameters, including typical parameters, must be validated for each customer application by the customer's technical experts. Product specifications do not expand or otherwise modify Vishay's terms and conditions of purchase, including but not limited to the warranty expressed therein.

Hyperlinks included in this datasheet may direct users to third-party websites. These links are provided as a convenience and for informational purposes only. Inclusion of these hyperlinks does not constitute an endorsement or an approval by Vishay of any of the products, services or opinions of the corporation, organization or individual associated with the third-party website. Vishay disclaims any and all liability and bears no responsibility for the accuracy, legality or content of the third-party website or for that of subsequent links.

Except as expressly indicated in writing, Vishay products are not designed for use in medical, life-saving, or life-sustaining applications or for any other application in which the failure of the Vishay product could result in personal injury or death. Customers using or selling Vishay products not expressly indicated for use in such applications do so at their own risk. Please contact authorized Vishay personnel to obtain written terms and conditions regarding products designed for such applications.

No license, express or implied, by estoppel or otherwise, to any intellectual property rights is granted by this document or by any conduct of Vishay. Product names and markings noted herein may be trademarks of their respective owners.