

# NK-26 NIPPER

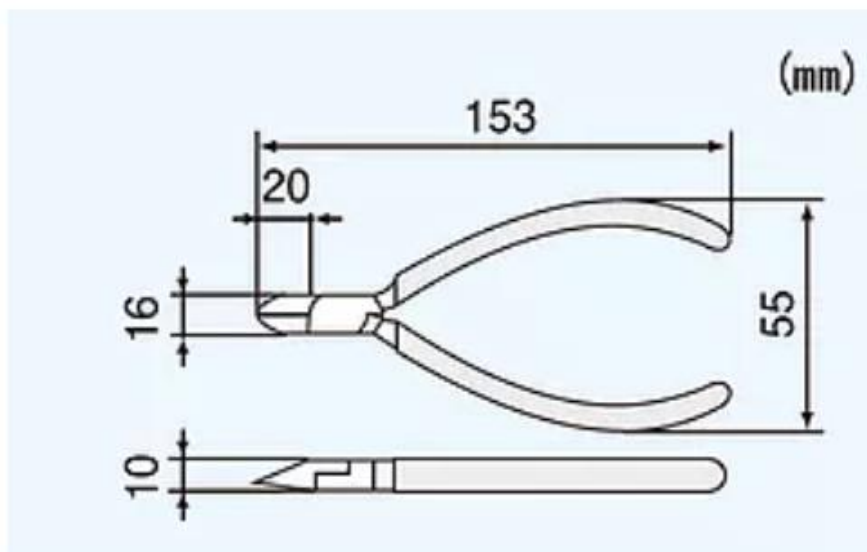

## Sharp and Durable cutting for precision wiring work

- Elaborately polished and sharpened cutting blade
- Material : High carbon steel
- With opening angle adjuster
- With coiled spring
- NK-15 and NK-16 without stripping hole
- NK-25 and NK-26 with stripping holes ( $\phi 1.2$  &  $\phi 1.6$  mm)



Item no.	Size	Material	Hardness	Stripping Holes	Cutting Capacity
NK-15	130mm	S55C	HRC58±4	-	dia. 2.6mm (Copper Wire)
NK-16	153mm				dia. 3.0mm (Copper Wire)
NK-25	130mm			dia. 1.2 & 1.6mm	dia. 2.6mm (Copper Wire)
NK-26	153mm				dia. 3.0mm (Copper Wire)