

Converter - Brake - Inverter Module (CBI3) with Trench IGBT technology

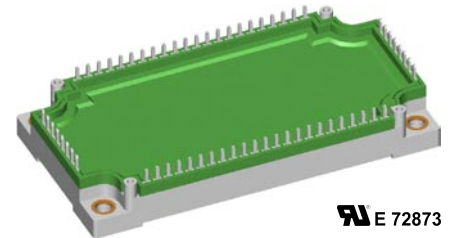
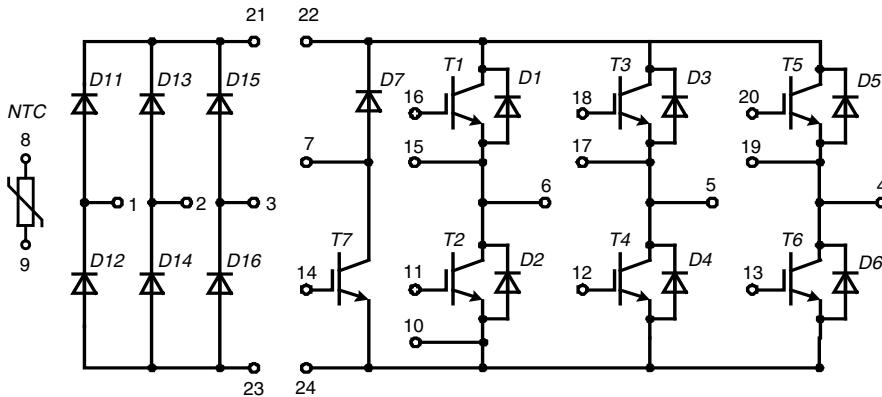

E 72873

Three Phase Rectifier	Brake Chopper	Three Phase Inverter
$V_{RRM} = 1600 \text{ V}$	$V_{CES} = 1200 \text{ V}$	$V_{CES} = 1200 \text{ V}$
$I_{FAVM} = 65 \text{ A}$	$I_{C25} = 55 \text{ A}$	$I_{C25} = 110 \text{ A}$
$I_{FSM} = 1100 \text{ A}$	$V_{CE(sat)} = 1.7 \text{ V}$	$V_{CE(sat)} = 1.7 \text{ V}$

Input Rectifier Bridge D11 - D16			
Symbol	Conditions	Maximum Ratings	
V_{RRM}		1600	V
I_{FAV}	$T_C = 80^\circ\text{C}$; sine 180°	65	A
I_{DAVM}	$T_C = 80^\circ\text{C}$; rectangular; $d = 1/3$; bridge	180	A
I_{FSM}	$T_C = 25^\circ\text{C}$; $t = 10 \text{ ms}$; sine 50 Hz	1100	A
P_{tot}	$T_C = 25^\circ\text{C}$	155	W

Symbol	Conditions	Characteristic Values			
		$(T_{VJ} = 25^\circ\text{C}, \text{ unless otherwise specified})$			
		min.	typ.	max.	
V_F	$I_F = 75 \text{ A}$; $T_{VJ} = 25^\circ\text{C}$		1.15	1.3	V
		$T_{VJ} = 125^\circ\text{C}$		1.05	
I_R	$V_R = V_{RRM}$; $T_{VJ} = 25^\circ\text{C}$		0.8	0.05	mA
	$T_{VJ} = 125^\circ\text{C}$				mA
R_{thJC}	(per diode)			0.8	K/W

Application: AC motor drives with

- Input from single or three phase grid
- Three phase synchronous or asynchronous motor
- Electric braking operation

Features

- High level of integration - only one power semiconductor module required for the whole drive
- IGBT technology with low saturation voltage, low switching losses and tail current, high RBSOA and short circuit ruggedness
- Epitaxial free wheeling diodes with Hiperfast and soft reverse recovery
- Industry standard package with insulated copper base plate and soldering pins for PCB mounting
- Temperature sense included

Output Inverter T1 - T6			
Symbol	Conditions	Maximum Ratings	
V_{CES}	$T_{VJ} = 25^{\circ}\text{C}$ to 150°C	1200	V
V_{GES}	Continuous	± 20	V
I_{C25}	$T_C = 25^{\circ}\text{C}$	110	A
I_{C80}	$T_C = 80^{\circ}\text{C}$	75	A
I_{CM}	$T_C = 80^{\circ}\text{C}; t_p = 1 \text{ ms}$	150	A
P_{tot}	$T_C = 25^{\circ}\text{C}$	355	W

Symbol	Conditions	Characteristic Values			
		(T _{VJ} = 25°C, unless otherwise specified)			
		min.	typ.	max.	
$V_{CE(sat)}$	$I_C = 75 \text{ A}; V_{GE} = 15 \text{ V}$				$T_{VJ} = 25^{\circ}\text{C}$
					$T_{VJ} = 125^{\circ}\text{C}$
$V_{GE(th)}$	$I_C = 3 \text{ mA}; V_{GE} = V_{CE}$	5	5.8	6.5	V
I_{CES}	$V_{CE} = V_{CES}; V_{GE} = 0 \text{ V}$		1	4	mA mA
I_{GES}	$V_{CE} = 0 \text{ V}; V_{GE} = \pm 20 \text{ V}$			400	nA
C_{ies}	$V_{CE} = 25 \text{ V}; V_{GE} = 0 \text{ V}; f = 1 \text{ MHz}$		5.35		nF
Q_{Gon}	$V_{CE} = 600 \text{ V}; V_{GE} = 15 \text{ V}; I_C = 75 \text{ A}$		700		nC
$t_{d(on)}$	Inductive load, $T_{VJ} = 125^{\circ}\text{C}$ $V_{CE} = 600 \text{ V}; I_C = 75 \text{ A}$ $V_{GE} = \pm 15 \text{ V}; R_G = 4.7 \Omega$				ns
t_r					50
$t_{d(off)}$					520
t_f					90
E_{on}					7
E_{off}					9.5
RBSOA	$I_C = I_{CM}; V_{GE} = 15 \text{ V}$ $R_G = 4.7 \Omega; T_{VJ} = 125^{\circ}\text{C}$				$V_{CEK} \leq V_{CES} - L_S di/dt$
t_{SC} (SCSOA)	$V_{CE} = 720 \text{ V}; V_{GE} = \pm 15 \text{ V}; R_G = 4.7 \Omega$ $t_p \leq 10 \mu\text{s}; \text{non-repetitive}; T_{VJ} = 125^{\circ}\text{C}$		300		A
R_{thJC}				0.35	K/W

Output Inverter D1 - D6					
Symbol	Conditions	Maximum Ratings			
I_{F25}	$T_C = 25^{\circ}\text{C}$	155	A		
I_{F80}	$T_C = 80^{\circ}\text{C}$	75	A		
Symbol	Conditions	Characteristic Values			
		min.	typ.	max.	
V_F	$I_F = 75 \text{ A};$				$T_{VJ} = 25^{\circ}\text{C}$
					$T_{VJ} = 125^{\circ}\text{C}$
I_{RM}	$I_F = 75 \text{ A}; di_F/dt = -1500 \text{ A}/\mu\text{s};$ $T_{VJ} = 125^{\circ}\text{C}; V_R = 600 \text{ V}; V_{GE} = 0 \text{ V}$				A
Q_{rr}					135
t_{rr}					15
E_{rec}					160
R_{thJC}	(per diode)				0.4

Brake Chopper T7			
Symbol	Conditions	Maximum Ratings	
V_{CES}	$T_{VJ} = 25^{\circ}\text{C}$ to 150°C	1200	V
V_{GES}	Continuous	± 20	V
I_{C25}	$T_C = 25^{\circ}\text{C}$	55	A
I_{C80}	$T_C = 80^{\circ}\text{C}$	35	A
I_{CM}	$T_C = 80^{\circ}\text{C}$; $t_p = 1$ ms	70	A
P_{tot}	$T_C = 25^{\circ}\text{C}$	200	W

Symbol	Conditions	Characteristic Values				
($T_{VJ} = 25^{\circ}\text{C}$, unless otherwise specified)						
		min.	typ.	max.		
$V_{CE(sat)}$	$I_C = 35$ A; $V_{GE} = 15$ V		$T_{VJ} = 25^{\circ}\text{C}$	1.7	2.15	V
				$T_{VJ} = 125^{\circ}\text{C}$	2.0	
$V_{GE(th)}$	$I_C = 1.5$ mA; $V_{GE} = V_{CE}$	5	5.8	6.5	V	
I_{CES}	$V_{CE} = V_{CES}$; $V_{GE} = 0$ V		$T_{VJ} = 25^{\circ}\text{C}$		0.25	mA
				$T_{VJ} = 125^{\circ}\text{C}$	0.3	
I_{GES}	$V_{CE} = 0$ V; $V_{GE} = \pm 20$ V			400	nA	
C_{ies}	$V_{CE} = 25$ V; $V_{GE} = 0$ V; $f = 1$ MHz		2.5		nF	
Q_{Gon}	$V_{CE} = 600$ V; $V_{GE} = 15$ V; $I_C = 35$ A		330		nC	
$t_{d(on)}$ t_r $t_{d(off)}$ t_f E_{off}	Inductive load, $T_{VJ} = 125^{\circ}\text{C}$ $V_{CE} = 600$ V; $I_C = 35$ A $V_{GE} = \pm 15$ V; $R_G = 27$ Ω			90		ns
				50		ns
				520		ns
				90		ns
				4.8		mJ
RBSOA	$I_C = I_{CM}$; $V_{GE} = 15$ V $R_G = 27$ Ω ; $T_{VJ} = 125^{\circ}\text{C}$	$V_{CEK} \leq V_{CES} - L_S di/dt$			V	
t_{SC} (SCSOA)	$V_{CE} = 720$ V; $V_{GE} = \pm 15$ V; $R_G = 27$ Ω $t_p \leq 10$ μs ; non-repetitive; $T_{VJ} = 125^{\circ}\text{C}$		140		A	
R_{thJC}				0.62	K/W	

Brake Chopper D7			
Symbol	Conditions	Maximum Ratings	
V_{RRM}	$T_{VJ} = 25^{\circ}\text{C}$ to 150°C	1200	V
I_{F25}	$T_C = 25^{\circ}\text{C}$	50	A
I_{F80}	$T_C = 80^{\circ}\text{C}$	30	A

Symbol	Conditions	Characteristic Values				
		min.	typ.	max.		
V_F	$I_F = 35$ A;		$T_{VJ} = 25^{\circ}\text{C}$	2.5	3.3	V
				$T_{VJ} = 125^{\circ}\text{C}$	2.0	
I_R	$V_R = V_{RRM}$;			0.25	mA	
				0.5	mA	
R_{thJC}	(per diode)			1.2	K/W	

Temperature Sensor NTC

Symbol	Conditions	Characteristic Values			
		min.	typ.	max.	
R_{25}	$T = 25^{\circ}\text{C}$	4.75	5.0	5.25	k Ω
$B_{25/50}$			3375		K

Module

Symbol	Conditions	Maximum Ratings	
T_{VJ}	operating	-40...+125	$^{\circ}\text{C}$
T_{JM}		+150	$^{\circ}\text{C}$
T_{stg}		-40...+125	$^{\circ}\text{C}$
V_{ISO}	$I_{ISOL} \leq 1\text{ mA}$; 50/60 Hz	2500	V~
M_d	Mounting torque (M5)	3 - 6	Nm

Symbol	Conditions	Characteristic Values		
		min.	typ.	max.
$R_{\text{therm-chip}}$	Resistance terminal to chip		5	m Ω
d_S	Creepage distance on surface	6		mm
d_A	Strike distance in air	6		mm
R_{thCH}	with heatsink compound		0.01	K/W
Weight			300	g

Dimensions in mm (1 mm = 0.0394")

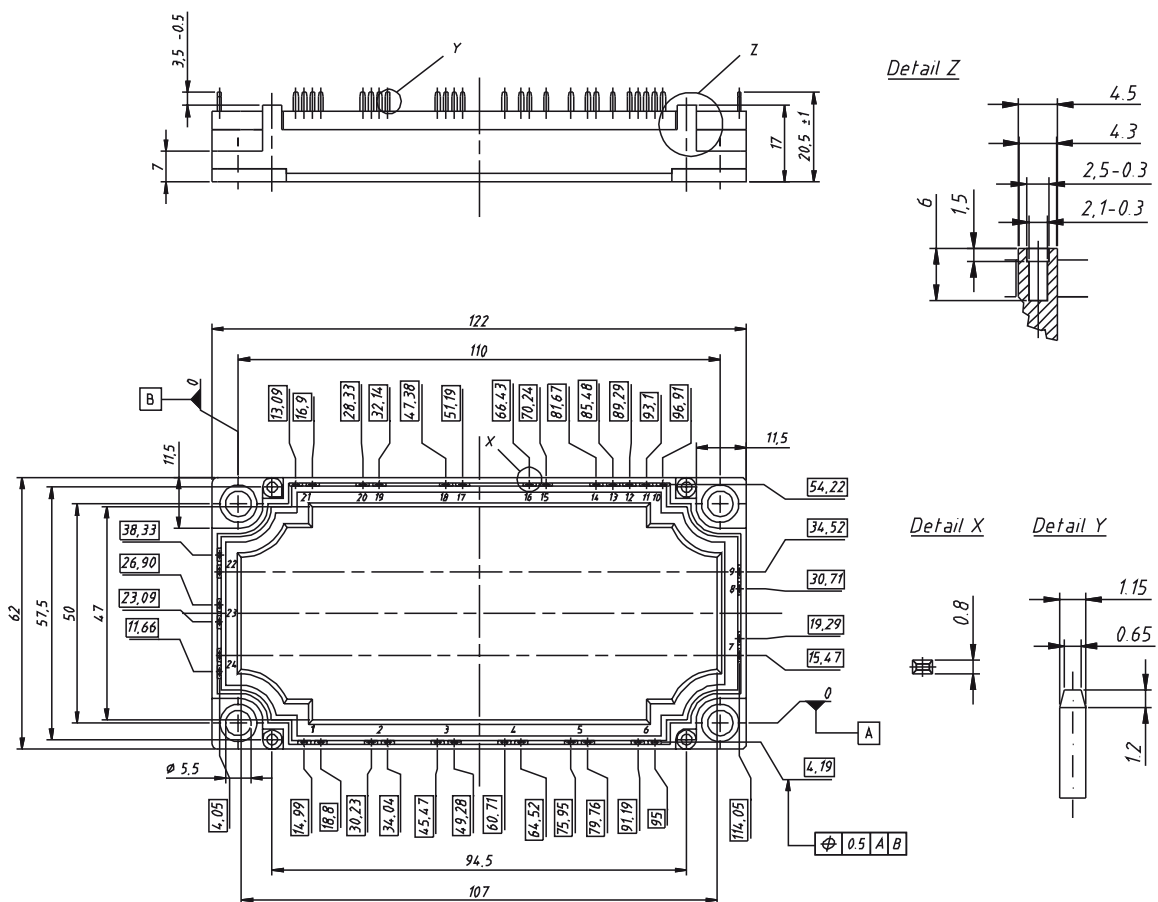

IXYS reserves the right to change limits, test conditions and dimensions.

© 2006 IXYS All rights reserved

Input Rectifier Bridge D11 - D16

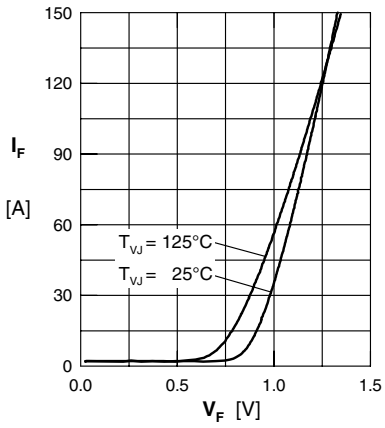

Fig. 1 Typ. forward current vs. voltage drop per diode

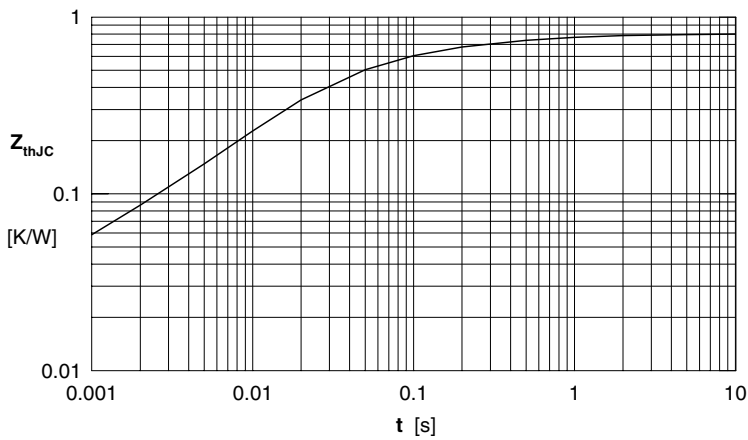

Fig. 2 Transient thermal impedance junction to case

Output Inverter T1 - T6 / D1 - D6

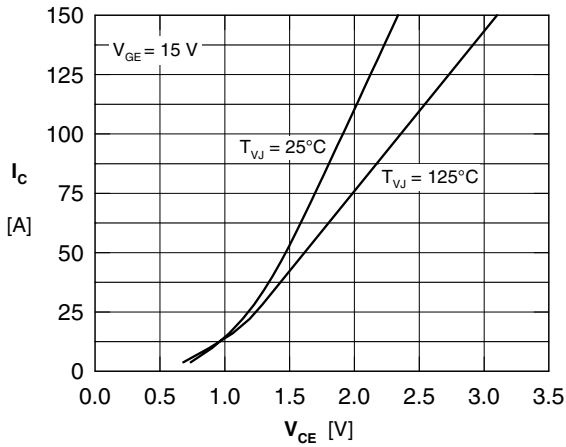

Fig. 3 Typical output characteristic

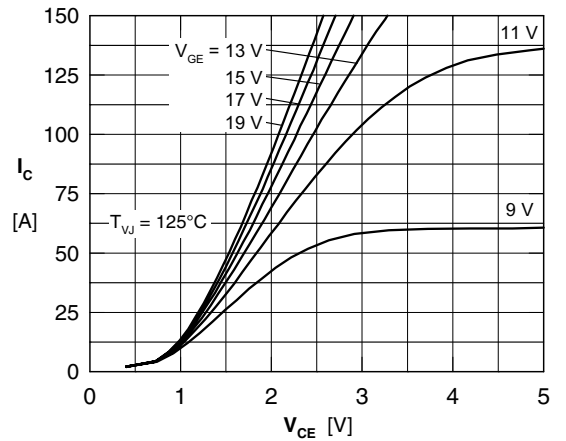

Fig. 4 Typical output characteristic

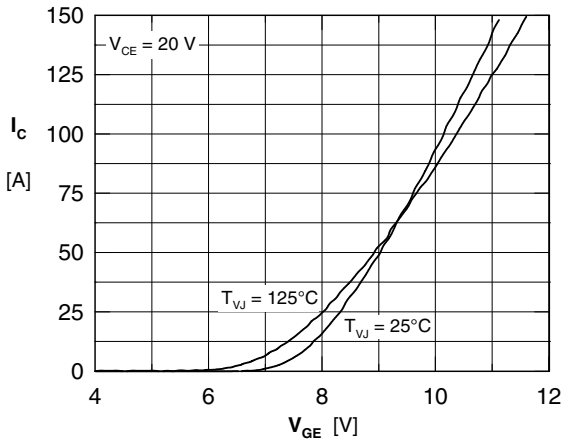

Fig. 5 Typical transfer characteristic

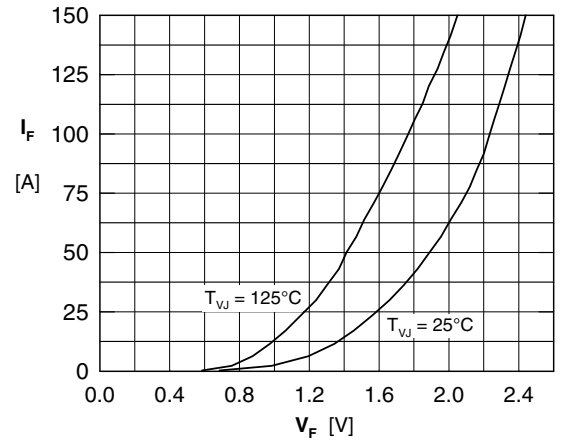

Fig. 6 Typical forward characteristic of free wheeling diode

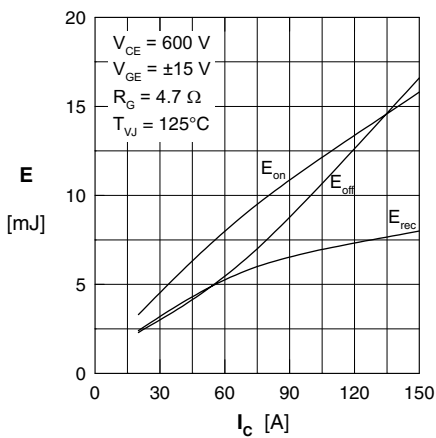

Fig. 7 Typical switching losses vs. collector current

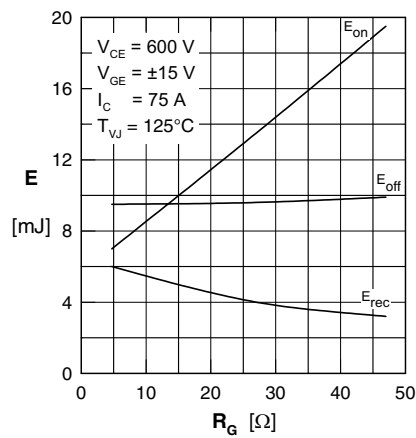

Fig. 8 Typ. switching losses vs. gate resistance

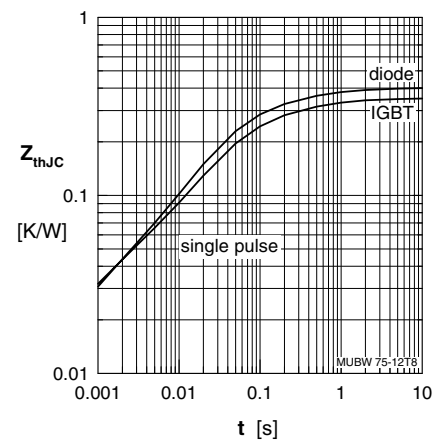

Fig. 9 Transient thermal impedance

Brake Chopper T7 / D7

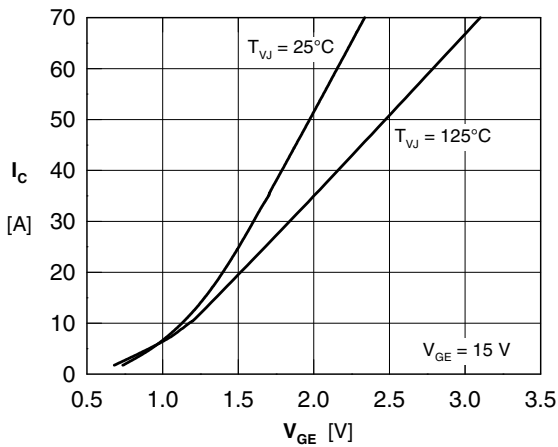

Fig. 10 Typical output characteristics

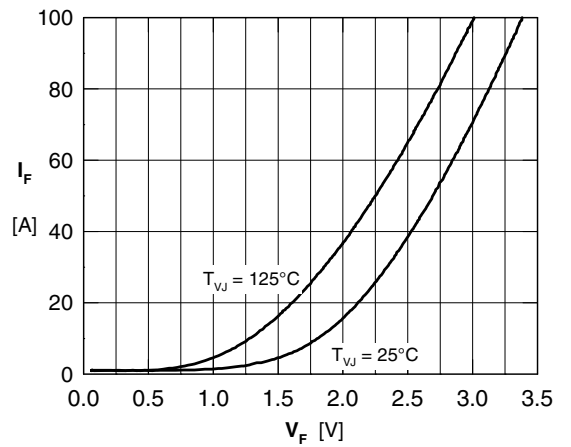

Fig. 11 Typical forward characteristics of free wheeling diode

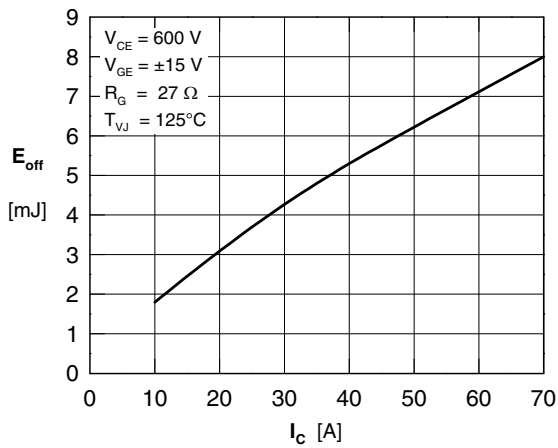

Fig. 12 Typ. turn off energy vs. collector current

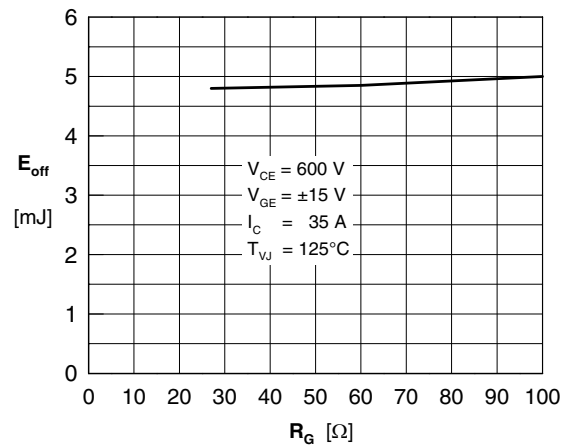

Fig. 13 Typ. turn off energy vs. gate resistor

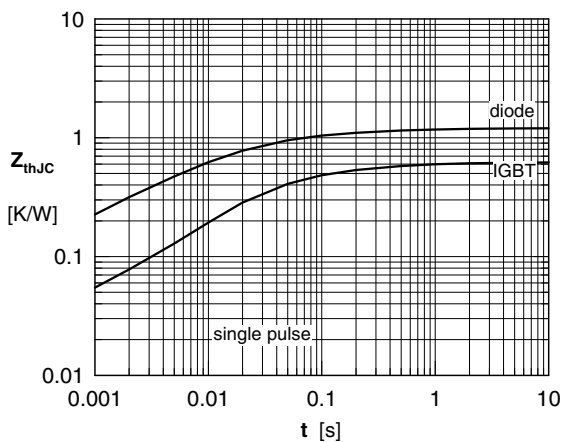

Fig. 14 Transient thermal impedance

Temperature Sensor NTC

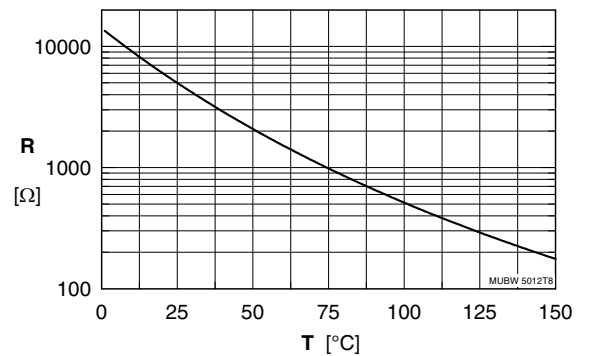

Fig. 15 Typ. termistor resistance versus temperature