

**SP3011 Series 0.40pF Diode Array for USB 3.0**

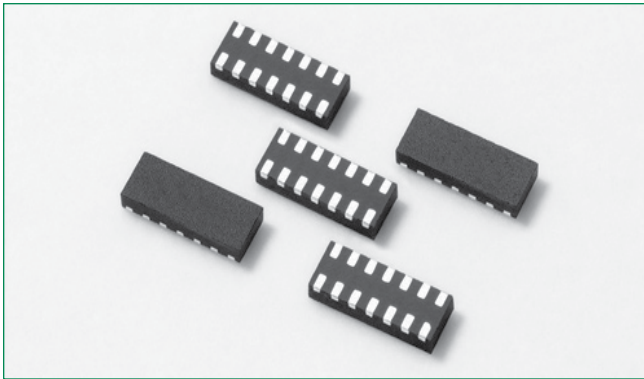

**Pinout**

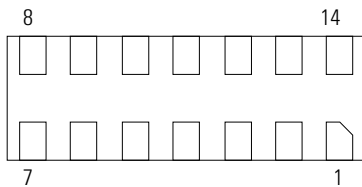

\*Pins 1, 2, 3, 4, 5, 6, 7 are not internally connected but should be connected to the opposite pin with the PCB trace.

**Functional Block Diagram**

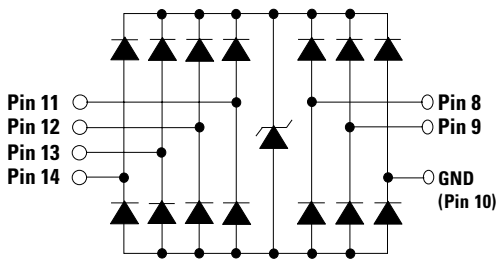

**Additional Information**



Datasheet



Resources



Samples

Life Support Note:

**Not Intended for Use in Life Support or Life Saving Applications**

The products shown herein are not designed for use in life sustaining or life saving applications unless otherwise expressly indicated.

**Description**

The SP3011 integrates six channels of ultra-low capacitance rail-to-rail diodes and an additional zener diode to provide protection for USB 3.0 ports that may experience destructive electrostatic discharges (ESD). This high density array can safely absorb repetitive ESD strikes at the maximum level specified in the IEC 61000-4-2 international standard (Level 4, ±8kV contact discharge) without performance degradation. It's extremely low loading capacitance makes it ideal for protecting any high-speed signal pins.

**Features**

- ESD, IEC 61000-4-2, ±8kV contact, ±15kV air
- EFT, IEC 61000-4-4, 40A (5/50ns)
- Lightning, IEC 61000-4-5, 3A (8/20µs)
- Low capacitance of 0.4pF (TYP) per I/O
- Low leakage current of 0.1µA (TYP) at 5V
- Small form factor µDFN (JEDEC MO-229) package saves board space
- RoHS compliant and lead-free
- AEC-Q101 qualified

**Applications**

- Notebooks
- External Storage
- Digital Camcorder
- MP3/PMP Player
- Desktops
- Ultramobile PC
- Smartphone
- Set Top Box (DVR/PVR)

**Application Example**

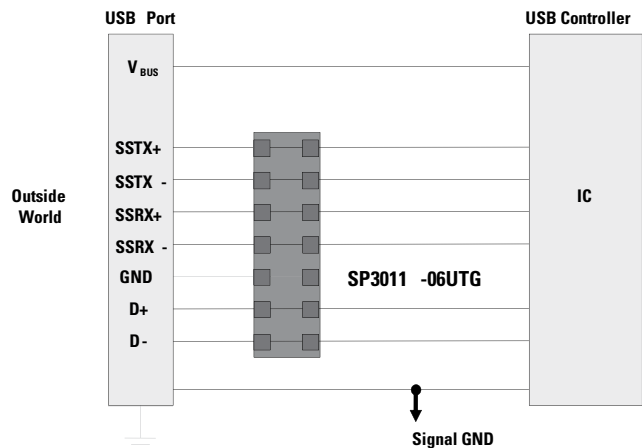

### Absolute Maximum Ratings

Symbol	Parameter	Value	Units
$I_{PP}$	Peak Current ( $t_p=8/20\mu s$ )	3.0	A
$T_{OP}$	Operating Temperature	-40 to 125	°C
$T_{STOR}$	Storage Temperature	-55 to 150	°C

**CAUTION:** Stresses above those listed in "Absolute Maximum Ratings" may cause permanent damage to the device. This is a stress only rating and operation of the device at these or any other conditions above those indicated in the operational sections of this specification is not implied.

### Electrical Characteristics ( $T_{OP}=25^\circ C$ )

Parameter	Symbol	Test Conditions	Min	Typ	Max	Units
Reverse Standoff Voltage	$V_{RWM}$	$I_R \leq 1\mu A$			6.0	V
Reverse Leakage Current	$I_{LEAK}$	$V_R=5V$ , Any I/O to GND		0.1	0.5	$\mu A$
Clamp Voltage <sup>1</sup>	$V_C$	$I_{PP}=1A$ , $t_p=8/20\mu s$ , Fwd		11.0		V
		$I_{PP}=2A$ , $t_p=8/20\mu s$ , Fwd		12.5		V
Dynamic Resistance	$R_{DYN}$	$(V_{C2}-V_{C1}) / (I_{PP2}-I_{PP1})$		1.5		$\Omega$
ESD Withstand Voltage <sup>1</sup>	$V_{ESD}$	IEC61000-4-2 (Contact)	$\pm 8$			kV
		IEC61000-4-2 (Air)	$\pm 15$			kV
Diode Capacitance <sup>1</sup>	$C_{I/O-GND}$	Reverse Bias=0V		0.4		pF

**Note:** <sup>1</sup> Parameter is guaranteed by design and/or device characterization.

### Capacitance vs. Bias Voltage

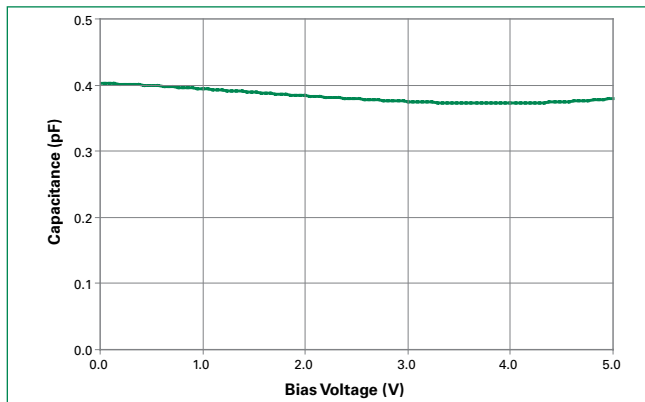

### Insertion Loss (S21) I/O to GND

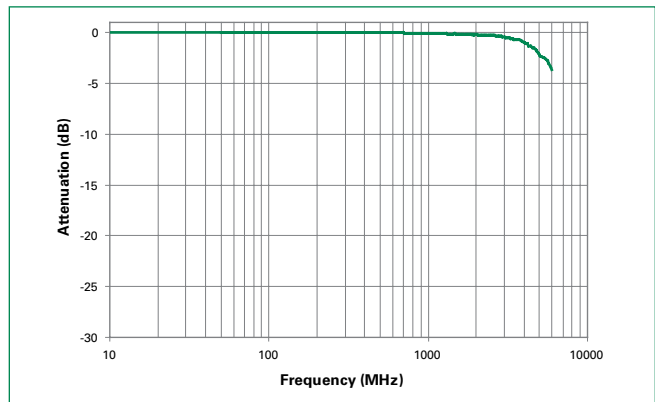

### Clamping Voltage vs. $I_{PP}$

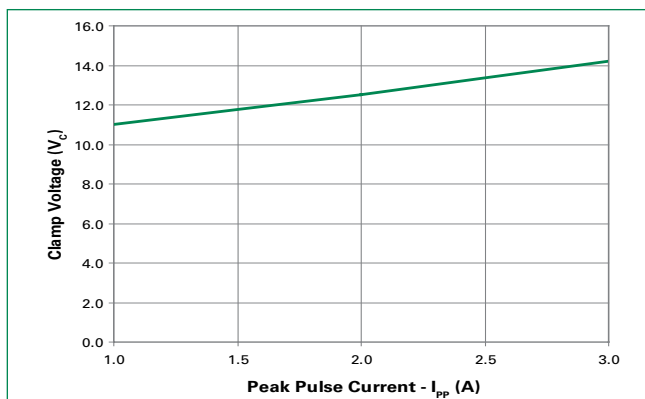

### Pulse Waveform

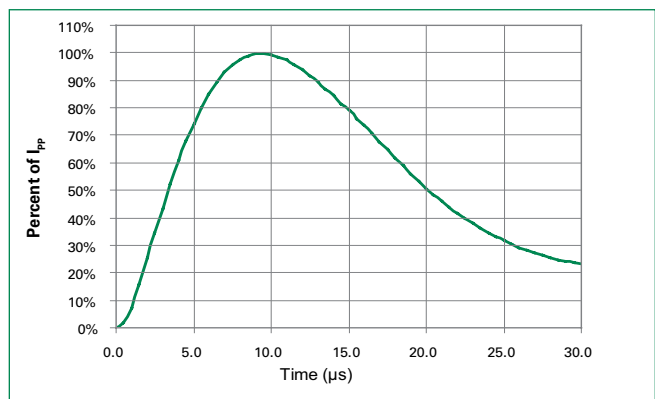

### Soldering Parameters

<b>Reflow Condition</b>		Pb – Free assembly
<b>Pre Heat</b>	- Temperature Min ( $T_{s(min)}$ )	150°C
	- Temperature Max ( $T_{s(max)}$ )	200°C
	- Time (min to max) ( $t_s$ )	60 – 180 secs
<b>Average ramp up rate (Liquidus) Temp (<math>T_L</math>) to peak</b>		3°C/second max
<b><math>T_{s(max)}</math> to <math>T_L</math> - Ramp-up Rate</b>		3°C/second max
<b>Reflow</b>	- Temperature ( $T_L$ ) (Liquidus)	217°C
	- Temperature ( $t_L$ )	60 – 150 seconds
<b>Peak Temperature (<math>T_p</math>)</b>		260 <sup>+0/-5</sup> °C
<b>Time within 5°C of actual peak Temperature (<math>t_p</math>)</b>		20 – 40 seconds
<b>Ramp-down Rate</b>		6°C/second max
<b>Time 25°C to peak Temperature (<math>T_p</math>)</b>		8 minutes Max.
<b>Do not exceed</b>		260°C

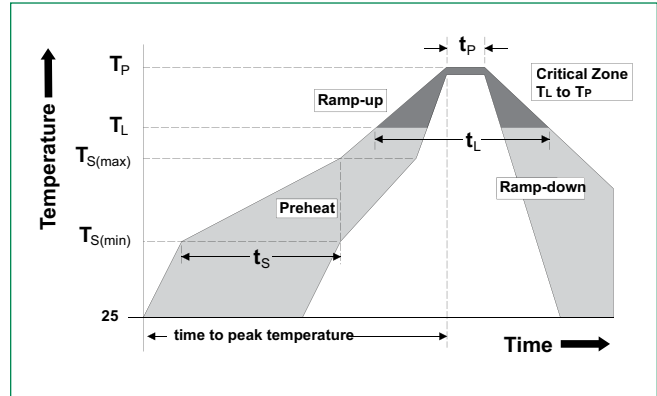

### Part Numbering System

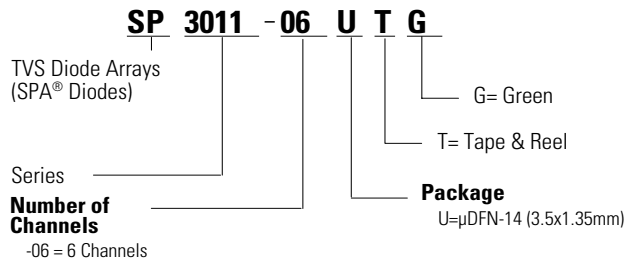

### Product Characteristics

<b>Lead Plating</b>	Pre-Plated Frame
<b>Lead Material</b>	Copper Alloy
<b>Lead Coplanarity</b>	0.0004 inches (0.102mm)
<b>Substitute Material</b>	Silicon
<b>Body Material</b>	Molded Epoxy
<b>Flammability</b>	UL 94 V-0

**Notes :**

1. All dimensions are in millimeters
2. Dimensions include solder plating.
3. Dimensions are exclusive of mold flash & metal burr.
4. Blo is facing up for mold and facing down for trim/form, i.e. reverse trim/form.
5. Package surface matte finish VDI 11-13.

### Part Marking System

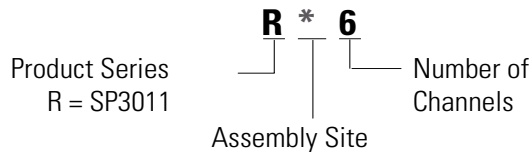

### Ordering Information

Part Number	Package	Min. Order Qty.
SP3011-06UTG	μDFN-14	3000

**Embossed Carrier Tape & Reel Specification – μDFN-14**

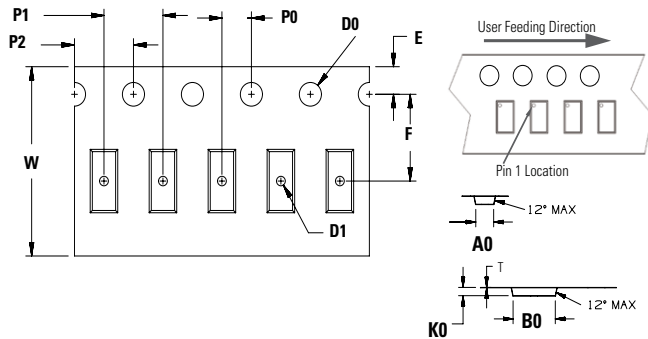

Symbol	Millimeters
A0	1.58 ± 0.10
B0	3.73 ± 0.10
D0	0.60 ± 0.05
D1	Ø 0.60 + 0.05
E	1.75 ± 0.10
F	5.50 ± 0.05
K0	0.68 ± 0.10
P0	2.00 ± 0.05
P1	4.00 ± 0.10
P2	4.00 ± 0.10
T	0.28 ± 0.02
W	12.00 + 0.30 /- 0.10

**Package Dimensions – μDFN-14 (3.5x1.35x0.5mm)**

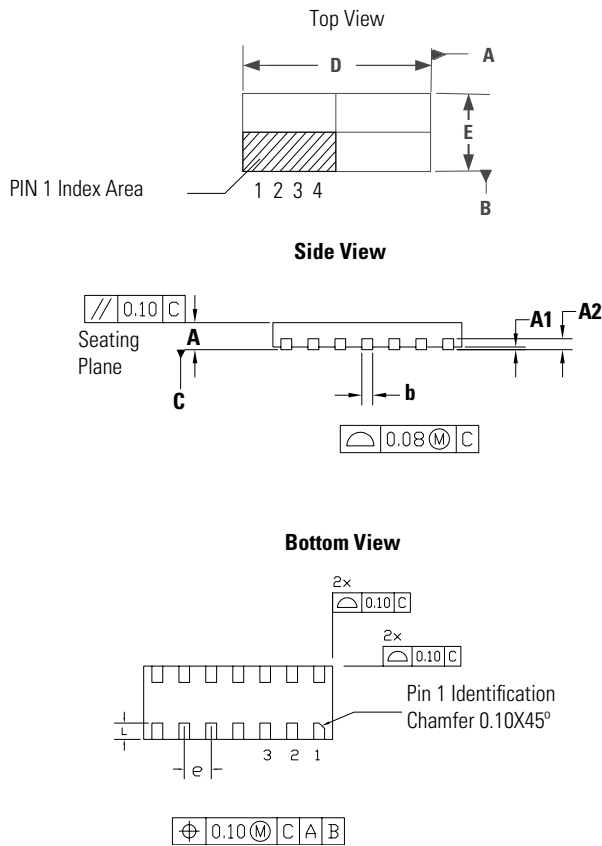

Package	μDFN-14 (3.5x1.35x0.5mm)					
JEDEC	MO-229					
Symbol	Millimeters			Inches		
	Min	Nom	Max	Min	Nom	Max
A	0.45	0.50	0.55	0.018	0.020	0.022
A1	0.00	0.02	0.05	0.000	0.001	0.002
A2	0.203 Ref			0.008 Ref		
b	0.15	0.20	0.25	0.006	0.008	0.012
D	3.40	3.50	3.60	0.134	0.138	0.142
D2	-	-	-	-	-	-
E	1.25	1.35	1.45	0.050	0.054	0.058
E1	-	-	-	-	-	-
e	0.500 BSC			0.020 BSC		
L	0.25	0.30	0.35	0.010	0.012	0.014

**Notes:**

1. Dimension and tolerancing conform to ASME Y14.5M-1994.
2. Controlling dimensions: Millimeter. Converted Inch dimensions are not necessarily exact.

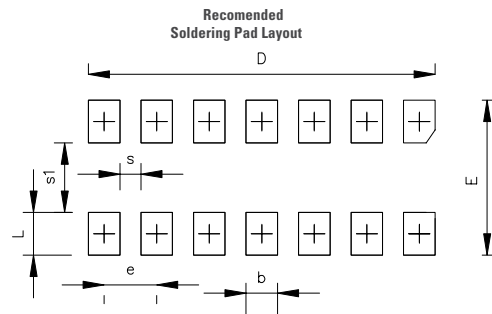

Symbol	Millimeter			Inches		
D	3.29	3.30	3.31	0.1295	0.1299	0.1303
E	1.44	1.45	1.46	0.0567	0.0571	0.0575
b	0.29	0.30	0.31	0.0114	0.0118	0.0122
L	0.39	0.40	0.41	0.0154	0.0158	0.0161
e	0.50typ			0.020typ		
s	0.19	0.20	0.21	0.0075	0.0078	0.0083
s1	0.64	0.65	0.66	0.0252	0.0256	0.0260