

Dept
Qty
DC 1
ED 1
IE 1
ISO 1
PD 1
R&D 1
SD 1
QA 1
QC 1
QE 1

The information provided herein is from CONNPLY Electronic Co., Ltd. and is confidential. Any disclosure to a party other than the recipient is prohibited. The intellectual properties and its rights contained herein, including but not limited to, trademarks, patents, copyrights, trade secrets, and technical know-how, are owned exclusively by CONNPLY or its affiliates. Unauthorized use or reproduction of this document, in any form or by any means, without the prior written consent of CONNPLY, is strictly prohibited. CONNPLY may enforce its intellectual property rights at its own discretion; failures or delays to exercise such rights does not constitute a waiver of such rights.

1 2 3 4 5 6 7 8

REV.	DESCRIPTION	DRAWN	CHECKED	APPROVED
A	NEW RELEASE	JLZ 01/18/21'		

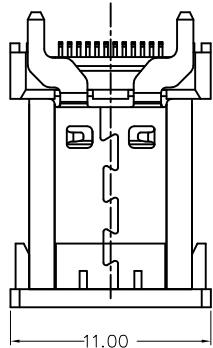

(COVER)

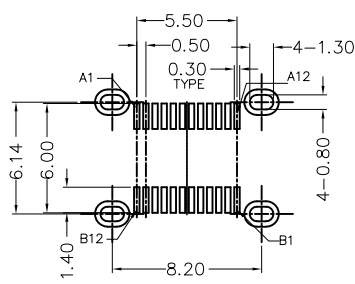

RECOMMEND P.C.B LAYOUT (COMPONENT SIDE)

TOLERANCE FOR PCB LAYOUT IS ± 0.05

KEEP OUT AREA

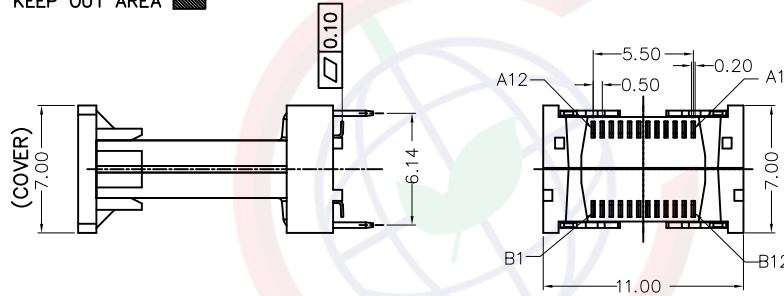
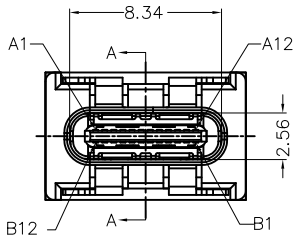

USB TYPE-C FULL-FEATURED RECEPTACLE INTERFACE PIN ASSIGNMENTS

PIN	Signal Name	Description	PIN	Signal Name	Description
A1	GND	Ground return	B12	GND	Ground return
A2	SSTxp1	Positive half of first SuperSpeed TX differential pair	B11	SSRxp1	Positive half of first SuperSpeed RX differential pair
A3	SSTxn1	Negative half of first SuperSpeed TX differential pair	B10	SSRxn1	Negative half of first SuperSpeed RX differential pair
A4	Vbus	Bus Power	B9	Vbus	Bus Power
A5	CC1	Configuration Channel	B8	SBU2	Sideband Use (SBU)
A6	Dp1	Positive half of the USB 2.0 differential pair-Position 1	B7	Dn2	Negative half of the USB 2.0 differential pair-Position 2
A7	Dn1	Negative half of the USB 2.0 differential pair-Position 1	B6	Dp2	Positive half of the USB 2.0 differential pair-Position 2
A8	SBU1	Sideband Use (SBU)	B5	CC2	Configuration Channel
A9	Vbus	Bus Power	B4	Vbus	Bus Power
A10	SSRXn2	Negative half of second SuperSpeed RX differential pair	B3	SSTXn2	Negative half of second SuperSpeed TX differential pair
A11	SSRXp2	Positive half of second SuperSpeed RX differential pair	B2	SSTXp2	Positive half of second SuperSpeed TX differential pair
A12	GND	Ground return	B1	GND	Ground return

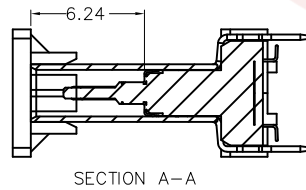
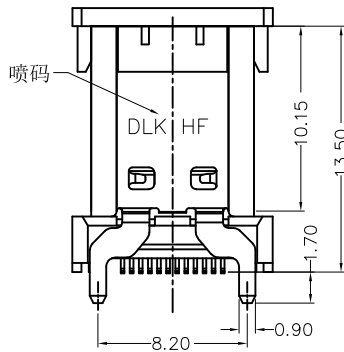

NOTE:

- Contact Resistance: 40mΩ Max. ;
- Dielectric Withstanding Voltage: 100V AC For 1 Minute;
- Insulation Resistance: 100M Ω Min. ;
- Mating And unmating Force:
Mating Force: 5~20N
Unmating Force: 8~20N (0~1000cycle);
6~20N (1001~10000cycle);
- Durability: 10000 Cycles;
- Product number code:

DS1144-39 - X X X X X X X X

- No. of contacts: 24: 24pin
- Connector type: F: Female
- Mounting type: S: SMT type
- Packing Type: R: Tape On Reel
- Shell Plating: N: Full Nickel
- Housing color: B: Black
- Contact Plating: 0: Selective gold flash; 5: Selective 15u" gold

Item	Title	Material	Dispose	Remark
1	Shell	Stainless Steel	Ni: 30u" Min.	
2	GND Plate	Stainless Steel		
3	Mid Plate	Stainless Steel	Solder Tails: Matt Tin	
4	Top Contact	Copper Alloy	Mating Area: See P/N	
5	Bottom Contact	Copper Alloy	Solder Tails: Matt Tin	
6	Insulator	High Temperature Plastic	UL 94V-0	Black



(Series Image-Reference Only)

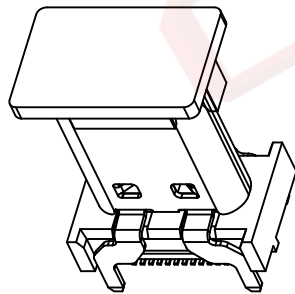

WITH COVER

GENERAL TOLERANCE		ANGLE TOLERANCE	
X.	±0.60	X.	±5°
.X	±0.38	.X	±3°
.XX	±0.25	.XX	±2°

DRAWING TYPE	CUSTOMER		
SCALE	1:1	SHEET	1 OF 1
DRAWING NO.	C-DS1144-39-XXXXXX-A		

PROJECTION	TITLE	SERIES
	USB C Type 24P Female V/T SMT Type H=13.5mm	DS1144-39 SERIES
UNITS	mm	
SHEET SIZE	A4	

晨翔电子有限公司
CONNPLY CONNPLY ELECTRONIC CO. LTD

1 2 3 4 5 6 7 8