

# Optocoupler, Phototransistor Output, Dual Channel

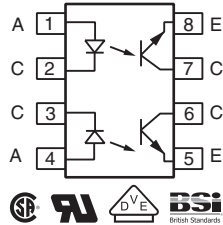
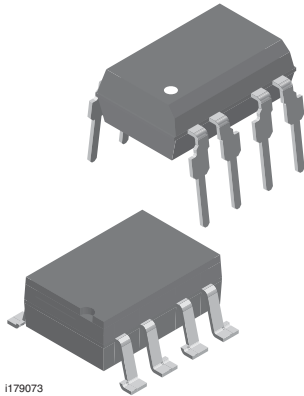

## FEATURES

- Current transfer ratio, 50 % typical
- Leakage current, 1.0 nA typical
- Two isolated channels per package
- Compliant to RoHS Directive and in accordance to WEEE 2002/96/EC

**RoHS**  
COMPLIANT

## AGENCY APPROVALS

- UL1577, file no. E52744 system code H, double protection
- DIN EN 60747-5-2 (VDE 0884)/DIN EN 60747-5-5 pending available with option 1
- CSA 93751
- BSI IEC 60950; IEC 60065

## DESCRIPTION

The MCT6 is a two channel optocoupler for high density applications. Each channel consists of an optically coupled pair with a gallium arsenide infrared LED and a silicon NPN phototransistor. Signal information, including a DC level, can be transmitted by the device while maintaining a high degree of electrical isolation between input and output.

The MCT6 is especially designed for driving medium-speed logic, where it may be used to eliminate troublesome ground loop and noise problems. It can also be used to replace relays and transformers in many digital interface applications, as well as analog applications such as CRT modulation.

## ORDERING INFORMATION

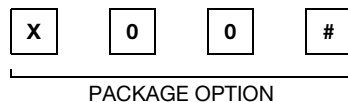
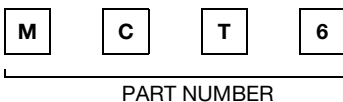
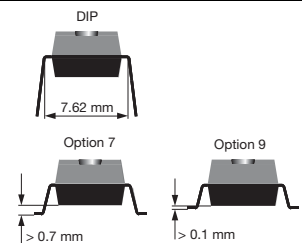
 TAPE AND  
REEL

| AGENCY CERTIFIED/PACKAGE | CTR                       |
|--------------------------|---------------------------|
| <b>UL, CSA, BSI</b>      | <b>≥ 20</b>               |
| DIP-8                    | MCT6                      |
| SMD-8, option 7          | MCT6-X007T <sup>(1)</sup> |
| SMD-8, option 9          | MCT6-X009T <sup>(1)</sup> |
| <b>VDE, UL, CSA, BSI</b> | <b>≥ 20</b>               |
| DIP-8                    | MCT6-X001                 |

### Notes

- Additional options may be possible, please contact sales office.
- <sup>(1)</sup> Also available in tubes, do not put "T" on the end.



## Optocoupler, Phototransistor Output, Vishay Semiconductors Dual Channel

| <b>ABSOLUTE MAXIMUM RATINGS</b> ( $T_{amb} = 25\text{ }^{\circ}\text{C}$ , unless otherwise specified) |   |            |                  |                        |
|--|---|------------|------------------|------------------------|
| PARAMETER  | TEST CONDITION  | SYMBOL     | VALUE            | UNIT                   |
| <b>INPUT</b>   |   |            |                  |                        |
| Rated forward current, DC  |   |            | 60               | mA                     |
| Peak forward current, DC   | 1.0 $\mu\text{s}$ pulse, 300 pps                                  | $I_{FM}$   | 3.0              | A                      |
| Power dissipation  |   | $P_{diss}$ | 100              | mW                     |
| Derate linearly from 25 $^{\circ}\text{C}$   |   |            | 1.3              | mW/ $^{\circ}\text{C}$ |
| <b>OUTPUT</b>  |   |            |                  |                        |
| Collector current  |   | $I_C$      | 30               | mA                     |
| Collector emitter breakdown voltage  |   | $BV_{CEO}$ | 30               | V                      |
| Power dissipation  |   | $P_{diss}$ | 150              | mW                     |
| Derate linearly from 25 $^{\circ}\text{C}$   |   |            | 2.0              | mW/ $^{\circ}\text{C}$ |
| <b>COUPLER</b>   |   |            |                  |                        |
| Isolation test voltage   |   | $V_{ISO}$  | 5300             | $V_{RMS}$              |
| Isolation resistance   | $V_{IO} = 500\text{ V}$ , $T_{amb} = 25\text{ }^{\circ}\text{C}$  | $R_{IO}$   | $M \geq 10^{12}$ | $\Omega$               |
|  | $V_{IO} = 500\text{ V}$ , $T_{amb} = 100\text{ }^{\circ}\text{C}$ | $R_{IO}$   | $\geq 10^{11}$   | $\Omega$               |
| Creepage distance  |   |            | $\geq 7.0$       | mm                     |
| Clearance distance   |   |            | $\geq 7.0$       | mm                     |
| Total package dissipation  |   | $P_{tot}$  | 400              | mW                     |
| Derate linearly from 25 $^{\circ}\text{C}$   |   |            | 5.33             | mW/ $^{\circ}\text{C}$ |
| Storage temperature  |   | $T_{stg}$  | - 55 to + 150    | $^{\circ}\text{C}$     |
| Operating temperature  |   | $T_{amb}$  | - 55 to + 100    | $^{\circ}\text{C}$     |
| Lead soldering time at 260 $^{\circ}\text{C}$  |   |            | 10               | s                      |

**Note**

- Stresses in excess of the absolute maximum ratings can cause permanent damage to the device. Functional operation of the device is not implied at these or any other conditions in excess of those given in the operational sections of this document. Exposure to absolute maximum ratings for extended periods of the time can adversely affect reliability.

| <b>ELECTRICAL CHARACTERISTICS</b> ( $T_{amb} = 25\text{ }^{\circ}\text{C}$ , unless otherwise specified) |   |             |      |      |      |               |
|--|---|-------------|------|------|------|---------------|
| PARAMETER  | TEST CONDITION  | SYMBOL      | MIN. | TYP. | MAX. | UNIT          |
| <b>INPUT</b>   |   |             |      |      |      |               |
| Forward voltage  | $I_F = 20\text{ mA}$  | $V_F$       |      | 1.25 | 1.50 | V             |
| Reverse current  | $V_R = 3.0\text{ V}$  | $I_R$       |      | 0.1  | 10   | $\mu\text{A}$ |
| Junction capacitance   | $V_F = 0\text{ V}$  | $C_j$       |      | 25   |      | pF            |
| <b>OUTPUT</b>  |   |             |      |      |      |               |
| Collector emitter breakdown voltage  | $I_C = 1.0\text{ }\mu\text{A}$ , $I_E = 10\text{ }\mu\text{A}$                | $BV_{CEO}$  | 30   | 65   |      | V             |
| Emitter collector breakdown voltage  | $I_C = 10\text{ }\mu\text{A}$ , $I_E = 10\text{ }\mu\text{A}$                 | $BV_{ECO}$  | 7.0  | 10   |      | V             |
| Collector emitter leakage current  | $V_{CE} = 10\text{ V}$  | $I_{CEO}$   |      | 1.0  | 100  | nA            |
| Collector emitter capacitance  | $V_{CE} = 0\text{ V}$   | $C_{CE}$    |      | 8.0  |      | pF            |
| <b>COUPLER</b>   |   |             |      |      |      |               |
| Saturation voltage, collector emitter  | $I_C = 2.0\text{ mA}$ , $I_F = 16\text{ mA}$                                  | $V_{CEsat}$ |      |      | 0.40 | V             |
| Capacitance (input to output)  | $f = 1.0\text{ MHz}$  | $C_{IO}$    |      | 0.5  |      | pF            |
| Capacitance between channels   | $f = 1.0\text{ MHz}$  |             |      | 0.4  |      | pF            |
| Bandwidth  | $I_C = 2.0\text{ mA}$ , $V_{CC} = 10\text{ V}$ ,<br>$R_L = 100\text{ }\Omega$ |             |      | 150  |      | kHz           |

**Note**

- Minimum and maximum values are testing requirements. Typical values are characteristics of the device and are the result of engineering evaluation. Typical values are for information only and are not part of the testing requirements.

| <b>CURRENT TRANSFER RATIO</b> ( $T_{amb} = 25\text{ }^{\circ}\text{C}$ , unless otherwise specified) |   |            |      |      |      |      |
|--|---|------------|------|------|------|------|
| PARAMETER  | TEST CONDITION                                | SYMBOL     | MIN. | TYP. | MAX. | UNIT |
| DC current transfer ratio  | $I_F = 10\text{ mA}$ , $V_{CE} = 10\text{ V}$ | $CTR_{DC}$ | 20   | 50   |      | %    |

| <b>SWITCHING CHARACTERISTICS</b> ( $T_{amb} = 25\text{ }^{\circ}\text{C}$ , unless otherwise specified) |   |                      |      |      |      |               |
|---|---|----------------------|------|------|------|---------------|
| PARAMETER   | TEST CONDITION  | SYMBOL               | MIN. | TYP. | MAX. | UNIT          |
| Switching times, output transistor  | $I_C = 2.0\text{ mA}$ , $R_L = 100\text{ }\Omega$ , $V_{CE} = 5\text{ V}$ | $t_{on}$ , $t_{off}$ |      | 3.0  |      | $\mu\text{s}$ |

### TYPICAL CHARACTERISTICS ( $T_{amb} = 25\text{ }^{\circ}\text{C}$ , unless otherwise specified)

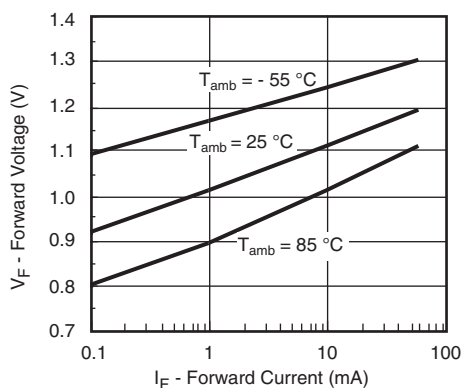

iiict6\_01

Fig. 1 - Forward Voltage vs. Forward Current

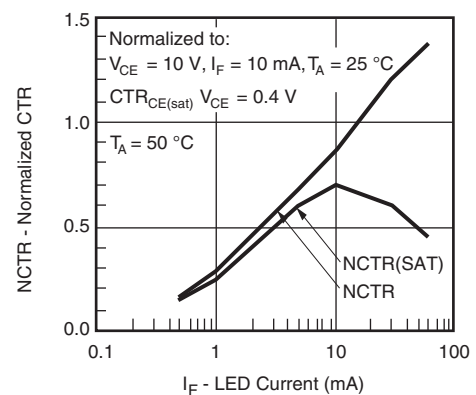

iiict6\_03

Fig. 3 - Normalized Non-Saturated and Saturated CTR vs. LED Current

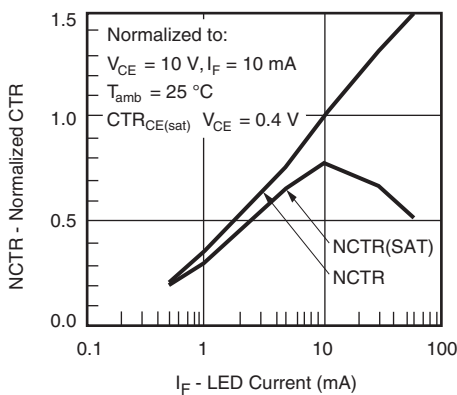

iiict6\_02

Fig. 2 - Normalized Non-Saturated and Saturated CTR vs. LED Current

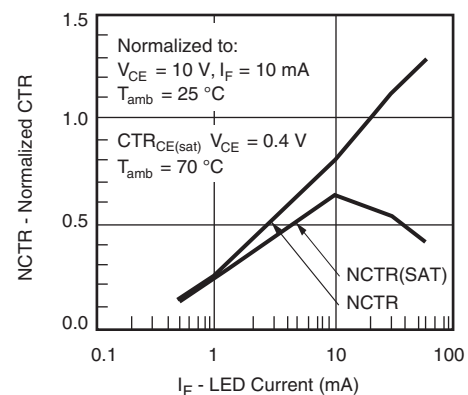

iiict6\_04

Fig. 4 - Normalized Non-Saturated and Saturated CTR vs. LED Current

# Optocoupler, Phototransistor Output, Vishay Semiconductors Dual Channel

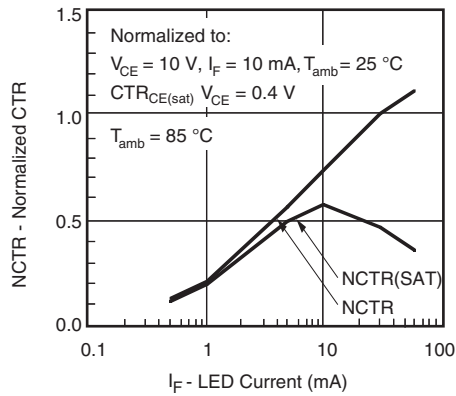

iilct6\_05

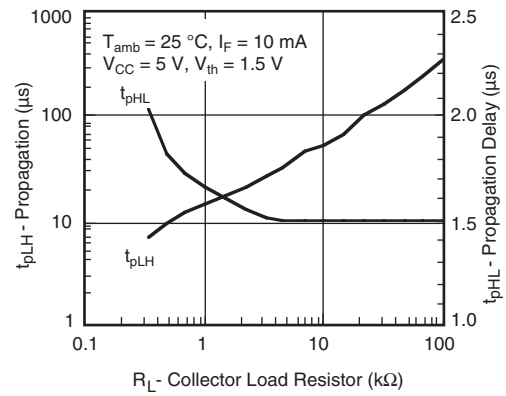
**Fig. 5 - Normalized Non-Saturated and Saturated CTR vs. LED Current**

iilct6\_08

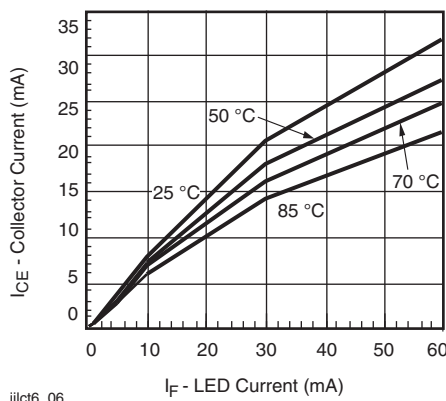
**Fig. 8 - Propagation Delay vs. Collector Load Resistor**

iilct6\_06

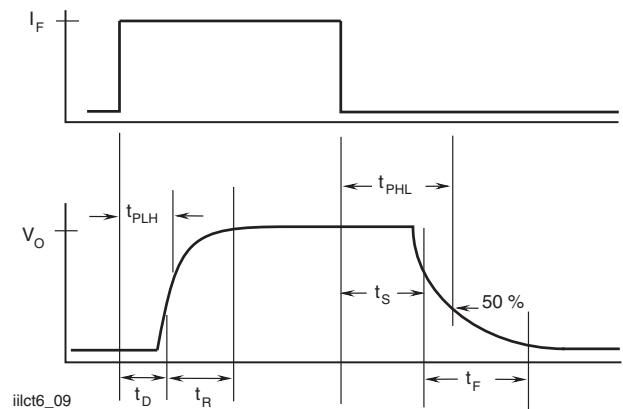
**Fig. 6 - Collector Emitter Current vs. Temperature and LED Current**

iilct6\_09

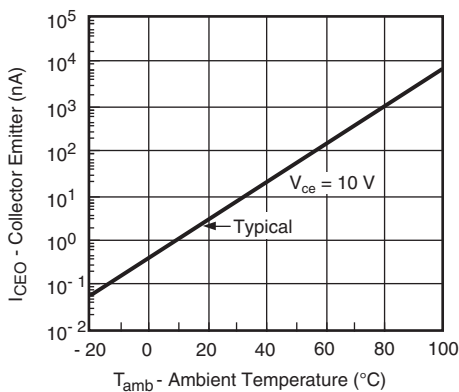
**Fig. 9 - Switching Timing**

iilct6\_07

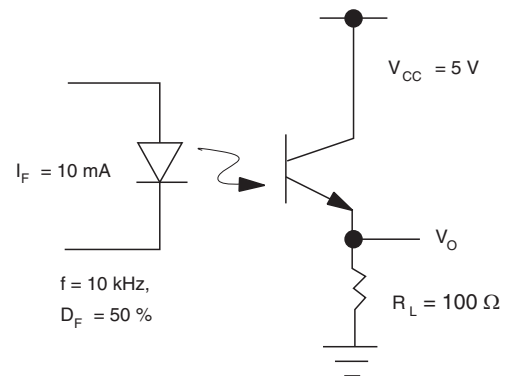
**Fig. 7 - Collector Emitter Leakage Current vs. Temperature**

iilct6\_10

**Fig. 10 - Switching Schematic**

# MCT6

Vishay Semiconductors Optocoupler, Phototransistor Output,  
Dual Channel



## PACKAGE DIMENSIONS in millimeters

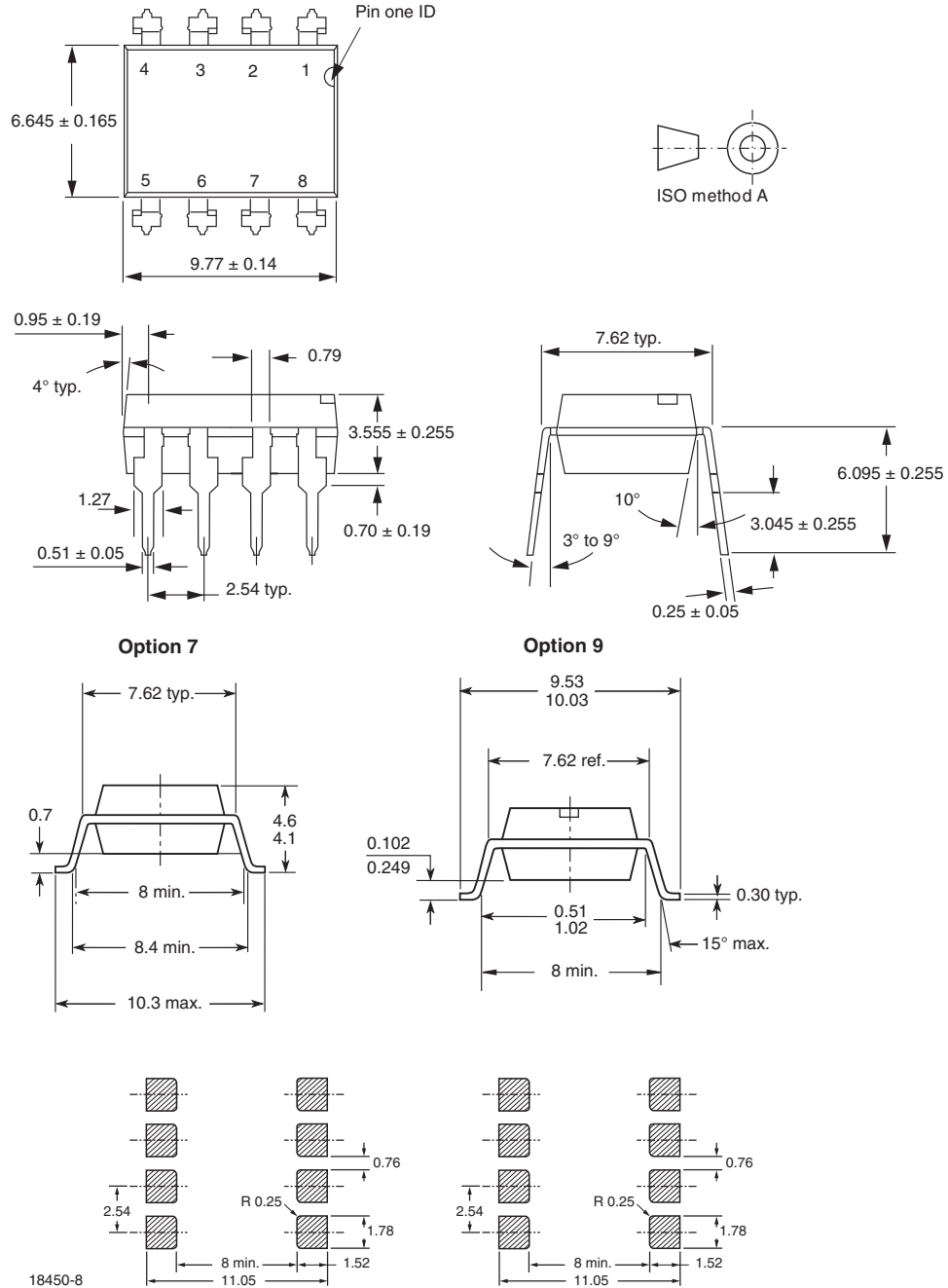

## PACKAGE MARKING

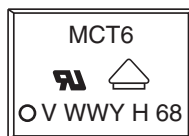

## Notes

- Only options 1 and 7 reflected in the package marking
- The VDE logo is only marked on option 1 parts
- Tape and reel suffix (T) is not part of the package marking



## **Disclaimer**

ALL PRODUCT, PRODUCT SPECIFICATIONS AND DATA ARE SUBJECT TO CHANGE WITHOUT NOTICE TO IMPROVE RELIABILITY, FUNCTION OR DESIGN OR OTHERWISE.

Vishay Intertechnology, Inc., its affiliates, agents, and employees, and all persons acting on its or their behalf (collectively, "Vishay"), disclaim any and all liability for any errors, inaccuracies or incompleteness contained in any datasheet or in any other disclosure relating to any product.

Vishay makes no warranty, representation or guarantee regarding the suitability of the products for any particular purpose or the continuing production of any product. To the maximum extent permitted by applicable law, Vishay disclaims (i) any and all liability arising out of the application or use of any product, (ii) any and all liability, including without limitation special, consequential or incidental damages, and (iii) any and all implied warranties, including warranties of fitness for particular purpose, non-infringement and merchantability.

Statements regarding the suitability of products for certain types of applications are based on Vishay's knowledge of typical requirements that are often placed on Vishay products in generic applications. Such statements are not binding statements about the suitability of products for a particular application. It is the customer's responsibility to validate that a particular product with the properties described in the product specification is suitable for use in a particular application. Parameters provided in datasheets and / or specifications may vary in different applications and performance may vary over time. All operating parameters, including typical parameters, must be validated for each customer application by the customer's technical experts. Product specifications do not expand or otherwise modify Vishay's terms and conditions of purchase, including but not limited to the warranty expressed therein.

Except as expressly indicated in writing, Vishay products are not designed for use in medical, life-saving, or life-sustaining applications or for any other application in which the failure of the Vishay product could result in personal injury or death. Customers using or selling Vishay products not expressly indicated for use in such applications do so at their own risk. Please contact authorized Vishay personnel to obtain written terms and conditions regarding products designed for such applications.

No license, express or implied, by estoppel or otherwise, to any intellectual property rights is granted by this document or by any conduct of Vishay. Product names and markings noted herein may be trademarks of their respective owners.