

TECHNICAL
SPECIFICATIONS

Product Code	PM060-HI22-SCH
Dimension (mm) W x L x H	50x50x10,6
Material	PMMA
Fastening	Screw
Beam Angle	60°
Type	4 in 1
Optical Efficiency	%93
Rohs Complaint	Yes

MATERIALS

PMMA clear, Non-yellowing for 10 years.
Yellowness Index (YI) according to the test standarts for Arizona/Florida outdoor exposure testing:
-YI 6 under hot/dry conditions
-YI 8 under hot/wet conditions

INSTRUCTIONS FOR USE &
MAINTENANCE

Working Temperature : -40° C ~ +100° C
Storage Temperature : -40° C ~ +100° C
Please handle or install lenses with wearing gloves.
Skin oils may damage lens or its optical characteristic.
Never use any commercial cleaning solvents on lenses , like alcohol.
If necessary, clean lenses wiht mild soap, water and soft cloth.

SAMSUNG LH351B

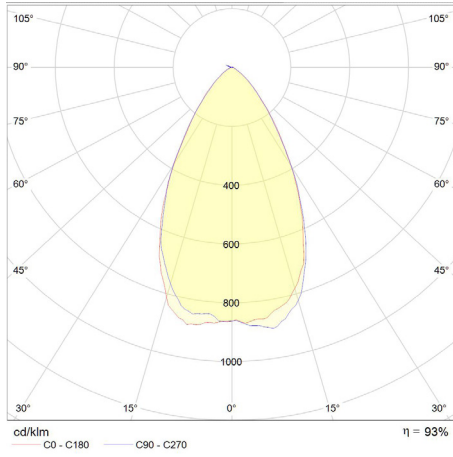

CREE XPG3

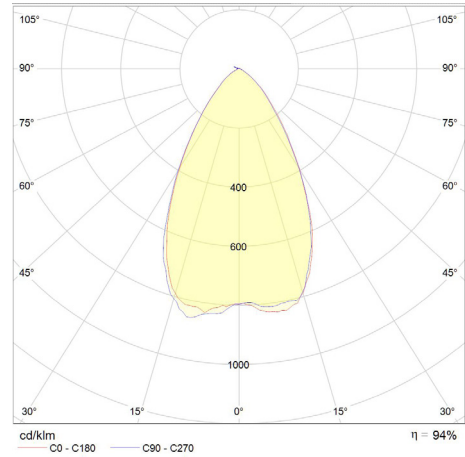

NICHIA NVSW219D

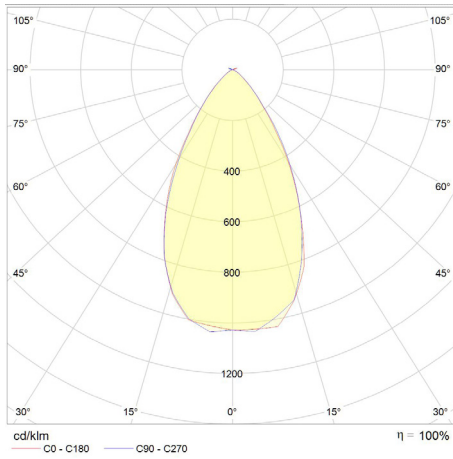

OSRAM OSLON SQUARE

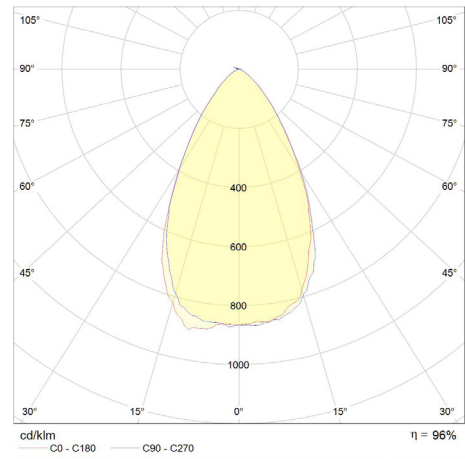

CREE XTE

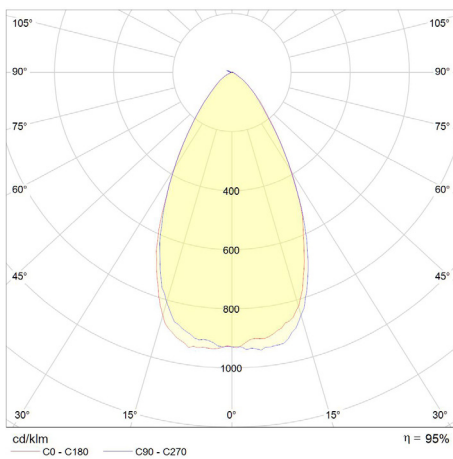

SEOUL Z5-M3

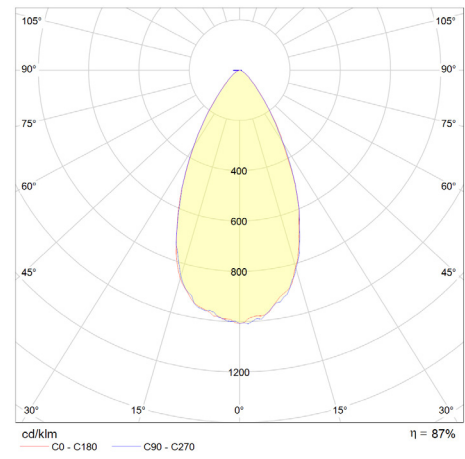

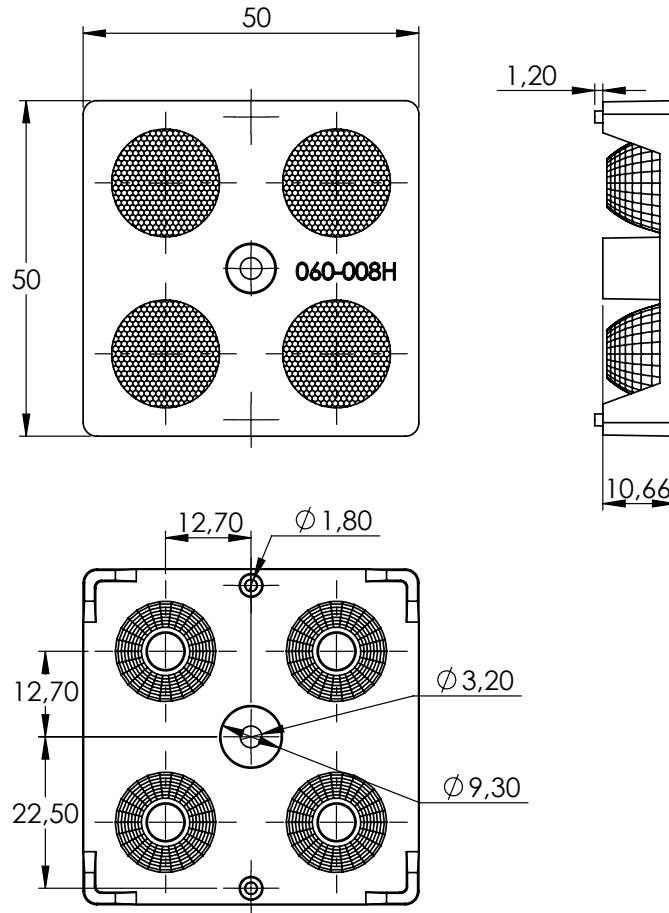

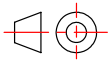
EMAGE [®]	UNIT mm	PART NO: PM060-HI22-SCH	 GENERAL TOLERANCES $\pm 0,2$ MM	
	MATERIAL	PMMA	REV.	REVISION
	WEIGHT	11,21 g	1	
	DATE	22.06.2020	2	
			3	
		PAGE 1 / 1	FORM	A4 SCALE 1:1

Box Size (mm) W x L x H	370x300x225
Box Weight	6,1 Kg
Box Quantity	600 pcs

