



## UT2316

Power MOSFET

### N-CHANNEL ENHANCEMENT MODE

#### DESCRIPTION

The UTC **UT2316** is N-channel enhancement mode Power MOSFET, designed in serried ranks with fast switching speed, low on-resistance and favorable stabilization.

Used in commercial and industrial surface mount applications and suited for low voltage applications such as DC/DC converters.

#### SYMBOL

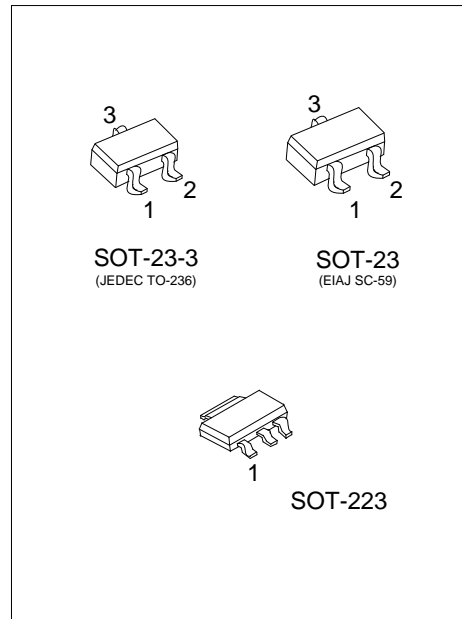
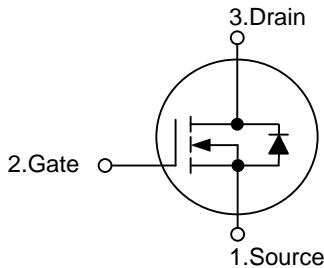

#### ORDERING INFORMATION

Ordering Number		Package	Pin Assignment			Packing
Lead Free	Halogen Free		1	2	3	
UT2316L-AA3-R	UT2316G-AA3-R	SOT-223	G	D	S	Tape Reel
UT2316L-AE2-R	UT2316G-AE2-R	SOT-23-3	G	S	D	Tape Reel
UT2316L-AE3-R	UT2316G-AE3-R	SOT-23	G	S	D	Tape Reel

Note: Pin Assignment: G: Gate D: Drain S: Source

<p>UT2316G-AA3-R</p> <p>(1) Packing Type</p> <p>(2) Package Type</p> <p>(3) Green Package</p>	<p>(1) R: Tape Reel</p> <p>(2) AA3: SOT-223, AE2: SOT-23-3, AE3: SOT-23</p> <p>(3) G: Halogen Free and Lead Free, L: Lead Free</p>
---	--

#### MARKING

SOT-23	SOT-223

### ■ ABSOLUTE MAXIMUM RATINGS (T<sub>A</sub> =25°C, unless otherwise specified)

PARAMETER	SYMBOL	RATING	UNIT
Drain-Source Voltage	V <sub>DS</sub>	30	V
Gate-Source Voltage	V <sub>GS</sub>	±20	V
Continuous Drain Current (Note 3)	I <sub>D</sub>	3.6	A
Pulsed Drain Current (Note 1, 2)	I <sub>DM</sub>	16	A
Total Power Dissipation (T <sub>A</sub> =25°C)	SOT-23-3	0.5	W
	SOT-23	0.6	W
	SOT-223	1	W
Junction Temperature	T <sub>J</sub>	+150	°C
Storage Temperature	T <sub>STG</sub>	-55 ~ +150	°C

Note: Absolute maximum ratings are those values beyond which the device could be permanently damaged. Absolute maximum ratings are stress ratings only and functional device operation is not implied.

### ■ THERMAL DATA

PARAMETER	SYMBOL	RATINGS	UNIT
Junction to Ambient (Note 3)	SOT-23-3	250	°C/W
	SOT-23	208	°C/W
	SOT-223	125	°C/W

Note: Device mounted on FR-4 substrate PC board, 2oz copper, with 1inch square copper plate.

### ■ ELECTRICAL CHARACTERISTICS (T<sub>J</sub> =25°C, unless otherwise specified)

PARAMETER	SYMBOL	TEST CONDITIONS	MIN	TYP	MAX	UNIT
<b>OFF CHARACTERISTICS</b>						
Drain-Source Breakdown Voltage	BV <sub>DSS</sub>	V <sub>GS</sub> =0V, I <sub>D</sub> =250μA	30			V
Drain-Source Leakage Current	I <sub>DSS</sub>	V <sub>DS</sub> =24V, V <sub>GS</sub> =0V			1	μA
Gate-Source Leakage Current	I <sub>GSS</sub>	V <sub>DS</sub> =0V, V <sub>GS</sub> =±20V			±100	nA
<b>ON CHARACTERISTICS</b>						
Gate Threshold Voltage	V <sub>GS(TH)</sub>	V <sub>DS</sub> =V <sub>GS</sub> , I <sub>D</sub> =250μA	0.8			V
On-State Drain Current	I <sub>D(ON)</sub>	V <sub>DS</sub> = 4.5V, V <sub>GS</sub> = 10V	6			A
		V <sub>DS</sub> = 4.5V, V <sub>GS</sub> = 4.5V	4			A
Drain-Source On-State Resistance (Note 2)	R <sub>DS(ON)</sub>	V <sub>GS</sub> =10V, I <sub>D</sub> =3.4A		42	50	mΩ
		V <sub>GS</sub> =4.5V, I <sub>D</sub> =2.6A		68	85	mΩ
<b>DYNAMIC CHARACTERISTICS</b>						
Input Capacitance	C <sub>ISS</sub>	V <sub>DS</sub> =15V, V <sub>GS</sub> =0V, f=1.0MHz		215		pF
Output Capacitance	C <sub>OSS</sub>			90		pF
Reverse Transfer Capacitance	C <sub>RSS</sub>			55		pF
<b>SWITCHING CHARACTERISTICS</b>						
Total Gate Charge	Q <sub>G</sub>	V <sub>DS</sub> =15V, V <sub>GS</sub> =10V, I <sub>D</sub> =3.6A		4.3	7	nC
Gate-Source Charge	Q <sub>GS</sub>			0.65		nC
Gate-Drain Charge	Q <sub>GD</sub>			1.2		nC
Turn-ON Delay Time	t <sub>D(ON)</sub>	V <sub>DD</sub> =15V, V <sub>GS</sub> =10V, I <sub>D</sub> =1A, R <sub>G</sub> =6Ω, R <sub>L</sub> =15Ω		9	15	ns
Turn-ON Rise Time	t <sub>R</sub>			9	15	ns
Turn-OFF Delay Time	t <sub>D(OFF)</sub>			14	20	ns
Turn-OFF Fall Time	t <sub>F</sub>			6	12	ns
<b>SOURCE- DRAIN DIODE RATINGS AND CHARACTERISTICS</b>						
Maximum Continuous Drain-Source Diode Forward Current	I <sub>S</sub>	V <sub>D</sub> =V <sub>G</sub> =0V, V <sub>S</sub> =1.2V		0.8		A
Drain-Source Diode Forward Voltage(Note2)	V <sub>SD</sub>	V <sub>GS</sub> =0V, I <sub>S</sub> =0.8A		0.88	1.2	V

Notes: 1. Repetitive Rating: Pulse width limited by maximum junction temperature.

2. Pulse width ≤300us, duty cycle ≤2%.

## TYPICAL CHARACTERISTICS

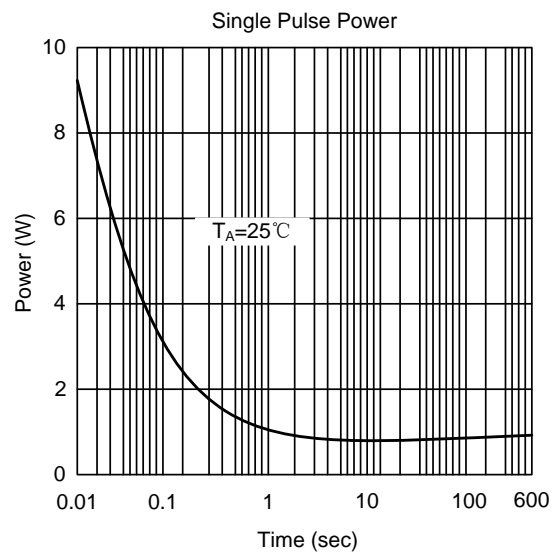
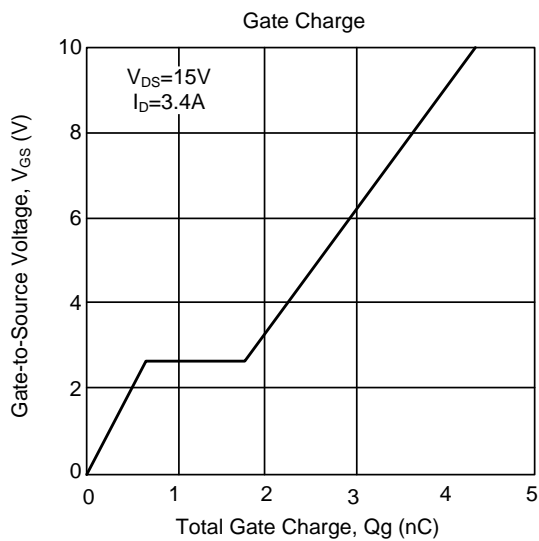
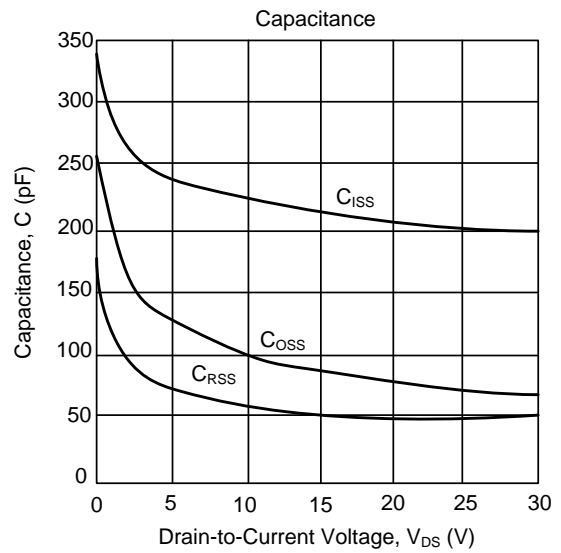
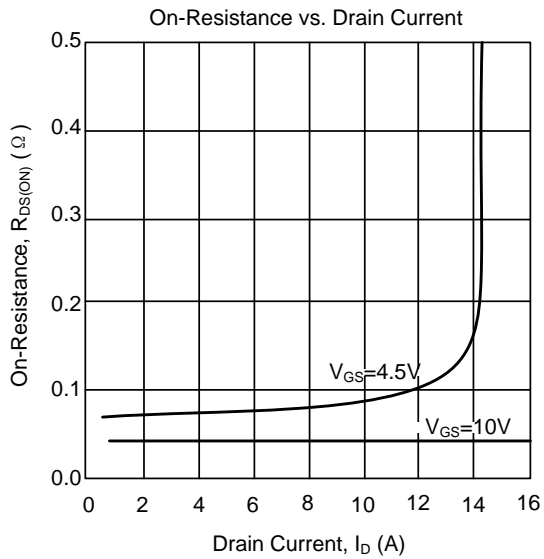
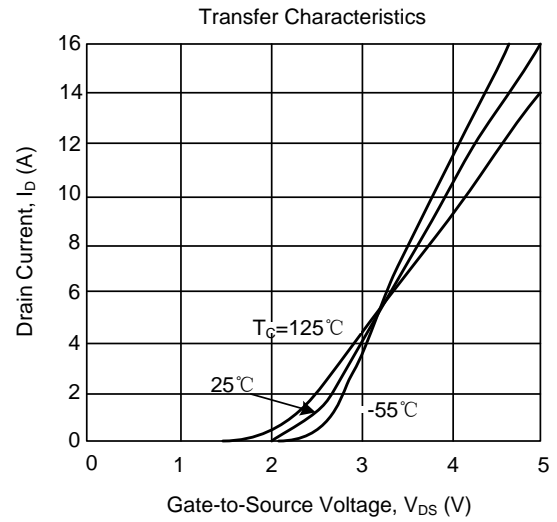
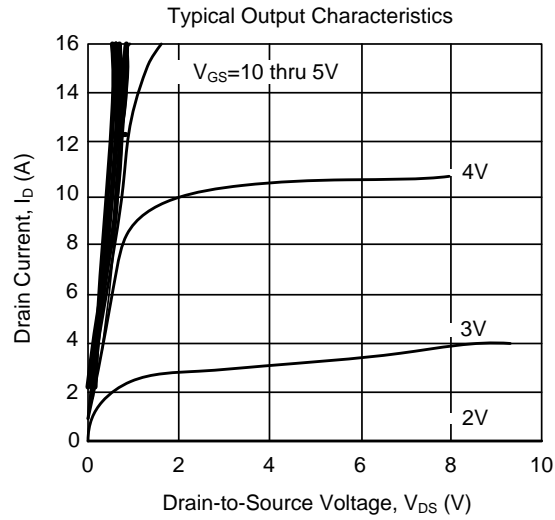

■ TYPICAL CHARACTERISTICS (Cont.)

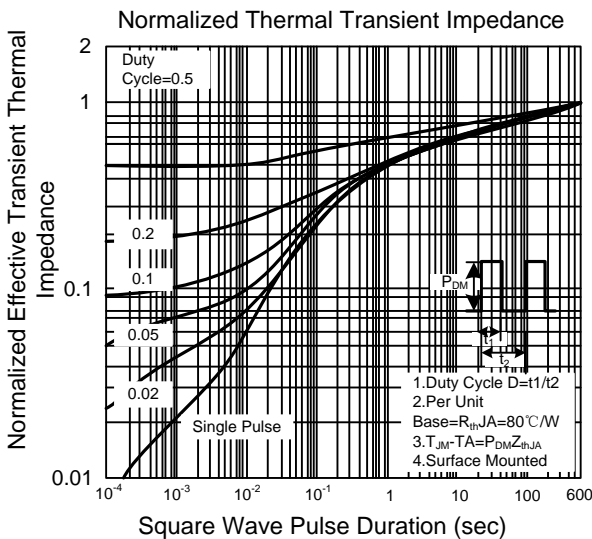
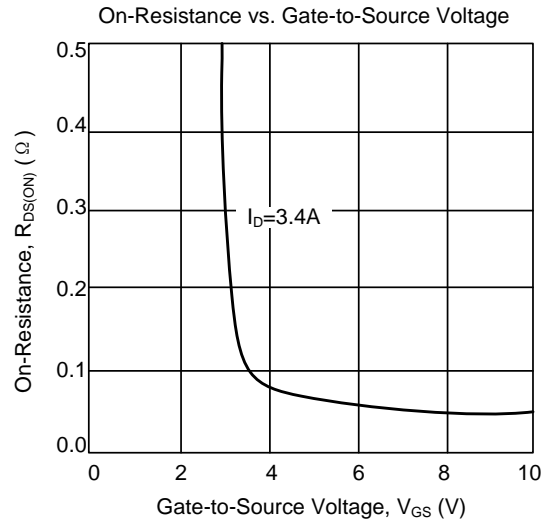
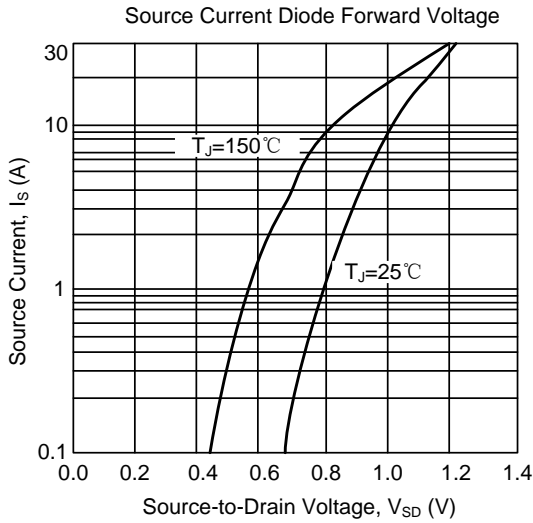

UTC assumes no responsibility for equipment failures that result from using products at values that exceed, even momentarily, rated values (such as maximum ratings, operating condition ranges, or other parameters) listed in products specifications of any and all UTC products described or contained herein. UTC products are not designed for use in life support appliances, devices or systems where malfunction of these products can be reasonably expected to result in personal injury. Reproduction in whole or in part is prohibited without the prior written consent of the copyright owner. UTC reserves the right to make changes to information published in this document, including without limitation specifications and product descriptions, at any time and without notice. This document supersedes and replaces all information supplied prior to the publication hereof.