

HF165FD

MINIATURE HIGH POWER RELAY



File No.: E134517



File No.: 40043143



File No.: CQC15002130956
CQC18002199524



Features

- 30A switching capability
- Breakdown voltage (between contact and coil): 4kV
- Creepage distance: 5.5mm(high voltage)
- Plastic sealed and flux proofed types available
- Product in accordance to IEC 60335-1 available
- UL insulation system: Class F

RoHS compliant

CONTACT DATA

Contact arrangement	1A	1B	1C	
Contact resistance ¹⁾	100mΩ max. (at 1A 6VDC)			
Contact material	AgSnO ₂			
Contact rating (Res. load)	30A 277VAC	15A 277VAC	20A 277VAC	10A 277VAC
Max. switching voltage	277VAC			
Max. switching current	30A	30A	30A	15A
Max. switching power	8310VA	8310VA	8310VA	4155VA
Mechanical endurance	1 x 10 ⁷ OPS			
Electrical endurance ²⁾	1 x 10 ⁵ OPS (NO: 30A 277VAC, Resistive load, Room temp., 1s on 9s off)			

Notes: 1) The data shown above are initial values.
2) For plastic sealed type, the venting-hole should be opened in electrical endurance test.

CHARACTERISTICS

Insulation resistance	1000MΩ (at 500VDC)	
Dielectric strength	Between open contacts	1500VAC 1min
	Between coil & contacts	2500VAC 1min(Standard) 4000VAC 1min(V Type)
Surge voltage	6kV (1.2/50μs)	
Operate time (at rated. volt.)	15ms max.	
Release time (at rated. volt.)	10ms max.	
Shock resistance	Functional	98m/s ²
	Destructive	980m/s ²
Vibration resistance	10Hz to 55Hz 1.5mm DA	
Humidity	5% to 85% RH	
Ambient temperature	-40°C to 85°C	
Termination	PCB	
Unit weight	Approx. 25g	
Construction	Plastic sealed	
	Flux proofed	

Notes: 1) The data shown above are initial values.

COIL

Coil power Approx. 900mW

COIL DATA

at 23°C

Nominal Voltage VDC	Pick-up Voltage VDC max ¹⁾	Drop-out Voltage VDC min ¹⁾	Max. Voltage VDC ²⁾	Coil Resistance Ω
5	3.75	0.5	6.5	27 x (1±10%)
6	4.50	0.6	7.8	40 x (1±10%)
9	6.75	0.9	11.7	97 x (1±10%)
12	9.00	1.2	15.6	155 x (1±10%)
15	11.25	1.5	19.5	256 x (1±10%)
18	13.50	1.8	23.4	380 x (1±10%)
24	18.00	2.4	31.2	660 x (1±10%)
48 ³⁾	36.00	4.8	62.4	2560 x (1±10%)
70 ³⁾	52.50	7.0	91.0	5500 x (1±10%)
110 ³⁾	82.50	11.0	143.0	13450 x (1±10%)

Notes: 1) The data shown above are initial values.
2) Maximum voltage refers to the maximum voltage which relay coil could endure in a short period of time.
3) For products with rated voltage ≥ 48V, measures should be taken to prevent coil overvoltage in order to protect coil in test and application (eg. Connect diodes in parallel).

SAFETY APPROVAL RATINGS

UL/CUL	NO	30A 277VAC at 85°C 20A 277VAC at 105°C 2HP 240VAC/1HP 120VAC at 40°C 96LRA 30FLA 277VAC at 40°C TV-8 125VAC at 40°C
		VDE
CO	30A 250VAC at 60°C 20A 250VAC at 85°C	
	15A 250VAC at 85°C 20A/10A 250VAC at 85°C	

Notes: 1) All values unspecified are at room temperature.
2) Only typical loads are listed above. Other load specifications can be available upon request.



HONGFA RELAY

ISO9001、ISO/TS16949、ISO14001、OHSAS18001、IECQC QC 080000 CERTIFIED

2019 Rev. 1.00

ORDERING INFORMATION

Type	HF165FD /12 -H Y1 S T F V (XXX)						
Coil voltage	5, 6, 9, 12, 15, 18, 24, 48, 70, 110						
Contact arrangement	H: 1 Form A D: 1 Form B Z: 1 Form C						
Termination	Y1: Without Pin NO.6			Y2: With Pin NO.6			
Construction ¹⁾	S: Plastic sealed			Nil: Flux proofed			
Contact material	T: AgSnO ₂						
Insulation standard	F: Class F						
Dielectric strength standard	Nil: Standard product(2500VAC Between coil & contacts)						
	V : High Dielectric strength(Only for Y1 Termination) (4000VAC Between coil & contacts)						
Special code ²⁾	XXX: Customer special requirement			Nil: Standard			

Notes: 1) We recommend flux proofed types for a clean environment (free from contaminations like H₂S, SO₂, NO₂, dust, etc.). We suggest to choose plastic sealed types and validate it in real application for an unclean environment (with contaminations like H₂S, SO₂, NO₂, dust, etc.).
2) The customer special requirement express as special code after evaluating by Hongfa. e.g.(335) stands for product in accordance to IEC 60335-1 (GWT).

OUTLINE DIMENSIONS, WIRING DIAGRAM AND PC BOARD LAYOUT

Unit: mm

Outline Dimensions

PCB Layout (Bottom view)

HF165FD/□□-HY1□□□□

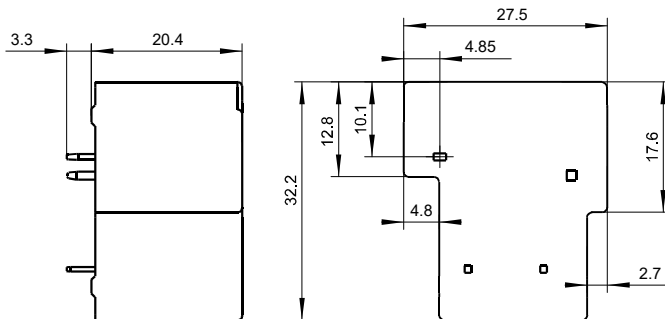

HF165FD/□□-HY1□□□□

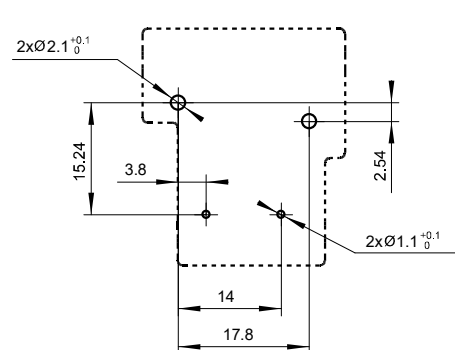

HF165FD/□□-HY2□□□□

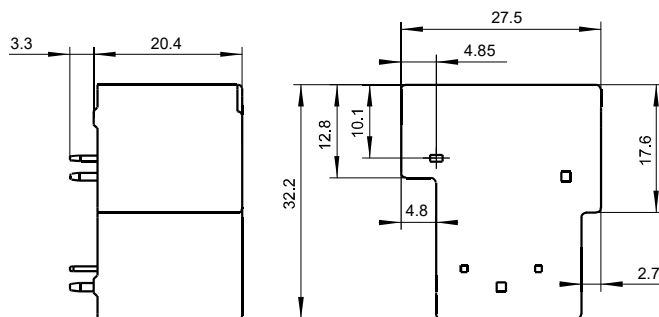

HF165FD/□□-HY2□□□□

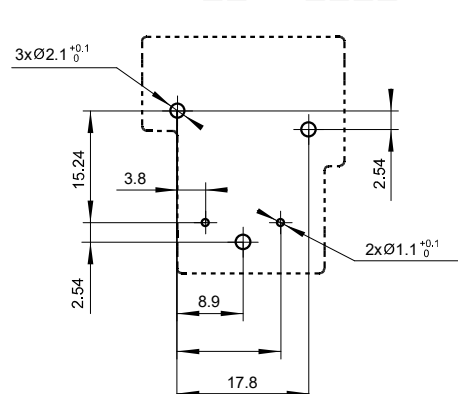

OUTLINE DIMENSIONS, WIRING DIAGRAM AND PC BOARD LAYOUT

Unit: mm

Outline Dimensions

HF165FD/□□-DY1□□□□

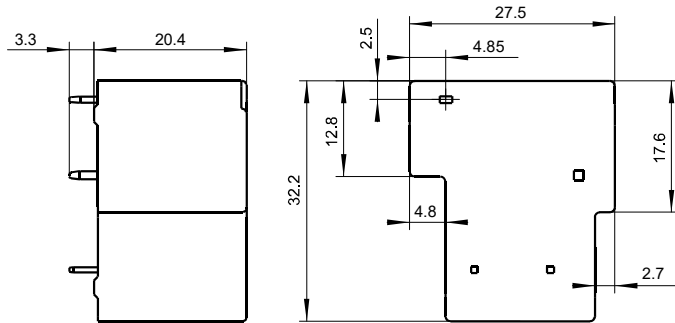

PCB Layout (Bottom view)

HF165FD/□□-DY1□□□□

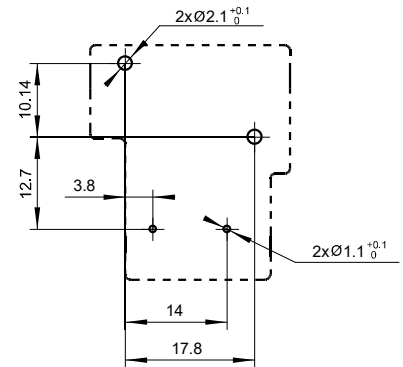

HF165FD/□□-DY2□□□□

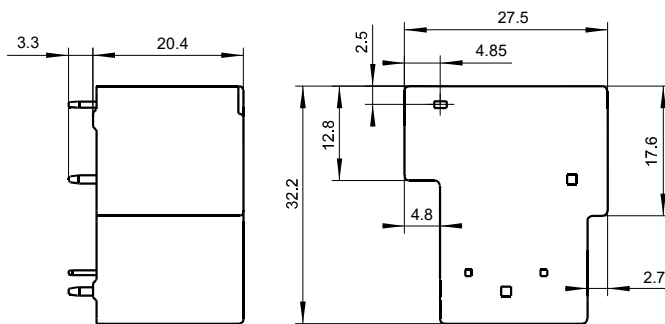

HF165FD/□□-DY2□□□□

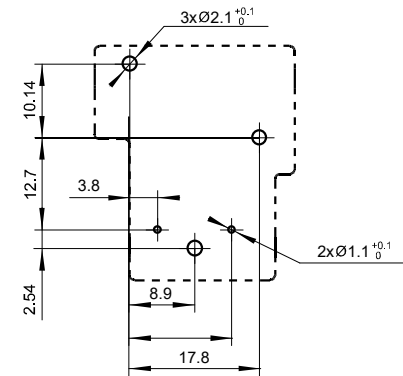

HF165FD/□□-ZY1□□□□

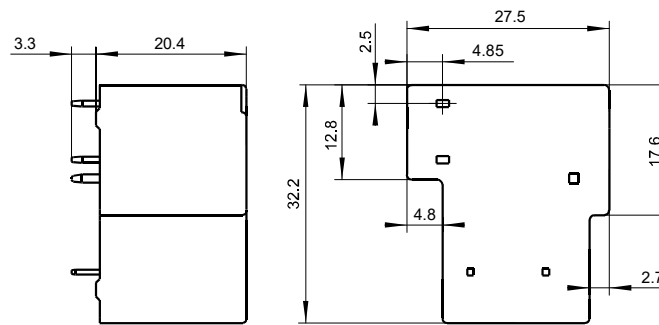

HF165FD/□□-ZY1□□□□

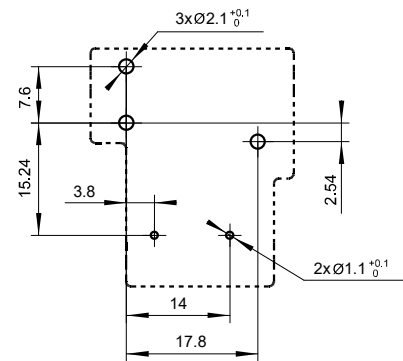

HF165FD/□□-ZY2□□□□

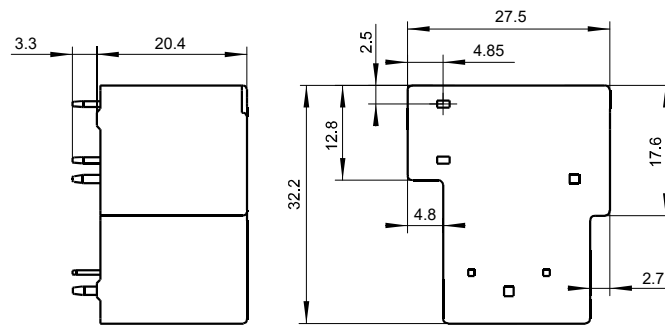

HF165FD/□□-ZY2□□□□

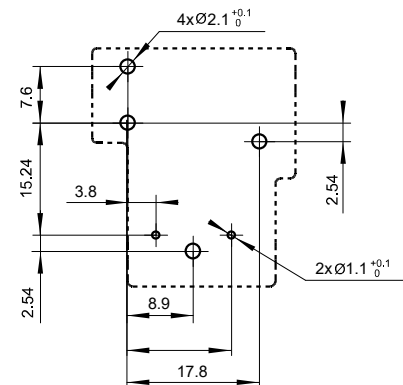

OUTLINE DIMENSIONS, WIRING DIAGRAM AND PC BOARD LAYOUT

Unit: mm

Wiring Diagram (Bottom view)

HF165FD/□□-HY1□□□□

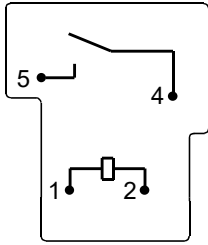

HF165FD/□□-DY1□□□□

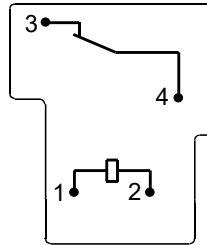

HF165FD/□□-ZY1□□□□

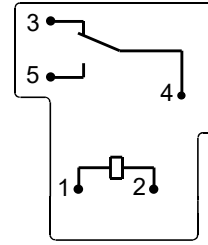

HF165FD/□□-HY2□□□□

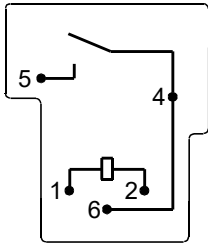

HF165FD/□□-DY2□□□□

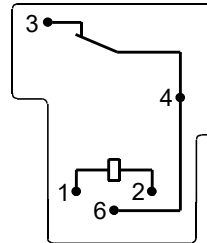

HF165FD/□□-ZY2□□□□

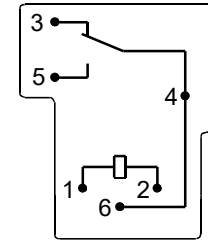

- Remark: 1) In case of no tolerance shown in outline dimension: outline dimension $\leq 1\text{mm}$, tolerance should be $\pm 0.2\text{mm}$; outline dimension $> 1\text{mm}$ and $\leq 5\text{mm}$, tolerance should be $\pm 0.3\text{mm}$; outline dimension $> 5\text{mm}$, tolerance should be $\pm 0.4\text{mm}$.
 2) The tolerance without indicating for PCB layout is always $\pm 0.1\text{mm}$.
 3) The width of the gridding is 2.5mm.

CHARACTERISTIC CURVES

MAXIMUM SWITCHING POWER

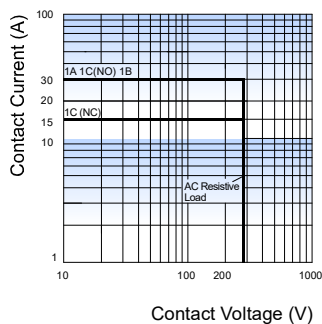

ENDURANCE CURVE

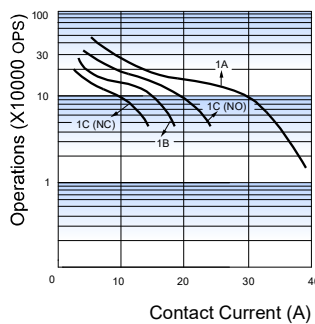

COIL OPERATING RANGE (AC)

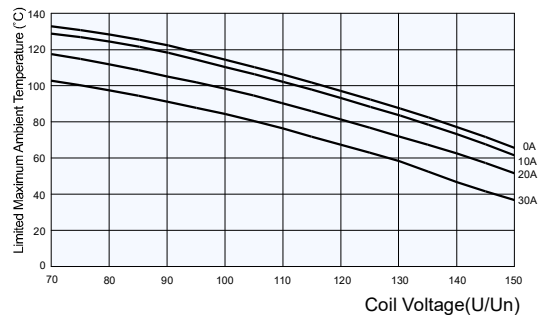

Test conditions:
 Flux proofed, Room temp.,
 1s on 9s off.

Disclaimer

The specification is for reference only. See to "Terminology and Guidelines" for more information. Specifications subject to change without notice. We could not evaluate all the performance and all the parameters for every possible application. Thus the user should be in a right position to choose the suitable product for their own application. If there is any query, please contact Hongfa for the technical service. However, it is the user's responsibility to determine which product should be used only.

© Xiamen Hongfa Electroacoustic Co., Ltd. All rights of Hongfa are reserved.