



**DC COMPONENTS CO., LTD.**  
RECTIFIER SPECIALISTS

**SMDJ5.0  
THRU  
SMDJ440CA**

**TECHNICAL SPECIFICATIONS OF TRANSIENT VOLTAGE SUPPRESSOR**  
**VOLTAGE RANGE - 5.0 to 440Volts    PEAK PULSE POWER - 3000 Watts**

**FEATURES**

- \* Glass passivated junction
- \* 3000 Watts Peak Pulse Power capability on 10/1000  $\mu$ s waveform
- \* Excellent clamping capability
- \* Low zener impedance
- \* Fast response time

**MECHANICAL DATA**

- \* Case: Molded plastic
- \* Epoxy: UL 94V-0 rate flame retardant
- \* Terminals: Solder plated solderable per MIL-STD-750, Method 2026
- \* Polarity: As marked
- \* Mounting position: Any
- \* Weight: 0.24 gram

**MAXIMUM RATINGS AND ELECTRICAL CHARACTERISTICS**

Ratings at 25°C ambient temperature unless otherwise specified.  
Single phase, half wave, 60 Hz, resistive or inductive load,  
For capacitive load, derate current by 20%.



**SMC(DO-214AB)**

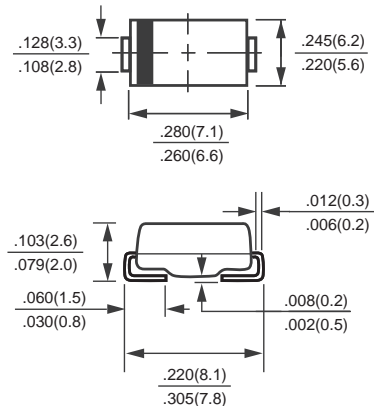

**DEVICES FOR BIPOLAR APPLICATIONS**

For Bidirectional use C or CA suffix (e.g. SMDJ5.0C, SMDJ440CA).

Electrical characteristics apply in both directions

	SYMBOL	VALUE	UNITS
Peak Pulse Power Dissipation on 10/1000 $\mu$ s waveform (Note 1, FIG. 1)	PPPM	Minimum 3000	Watts
Steady State Power Dissipation at T = 75°C Lead Lengths .375"(9.5mm) (Note 2)	P <sub>M(AV)</sub>	6.0	Watts
Peak Forward Surge Current, 8.3ms single half sine-wave superimposed on rated load(JEDEC Method) (Note 3)	I <sub>FSM</sub>	300	Amps
Maximum Instantaneous Forward Voltage at 50A for Unidirectional only	V <sub>F</sub>	3.5	Volts
Operating and Storage Temperature Range	T <sub>J</sub> , T <sub>STG</sub>	-55 to + 175	°C

- NOTES : 1. Non-repetitive current pulse, per Fig.5 and derated above TA = 25°C per Fig. 1.  
2. 8.3ms single half sine-wave or equivalent square wave, duty cycle = 4 pulses per minute maximum.  
3. VF<3.5V for devices of VBR<200V and VF<5.0V for devices of VBR>201V

# RATING AND CHARACTERISTIC CURVES (SMDJ5.0 THRU SMDJ440CA)

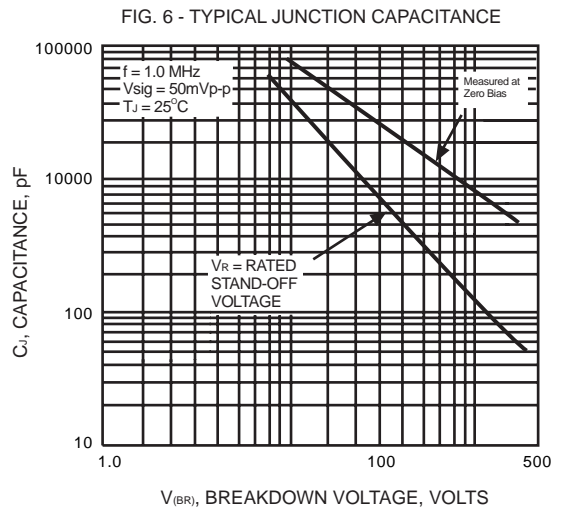
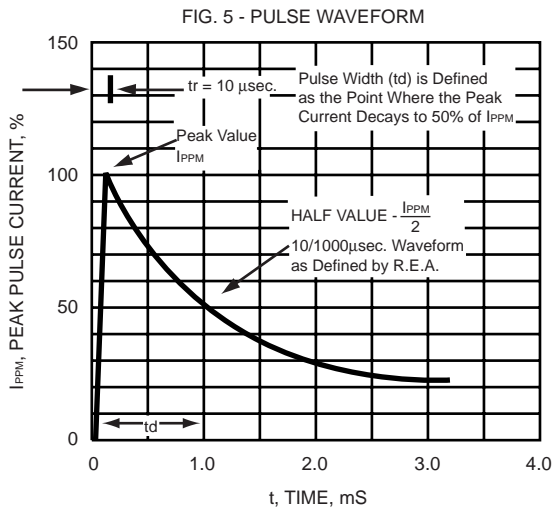
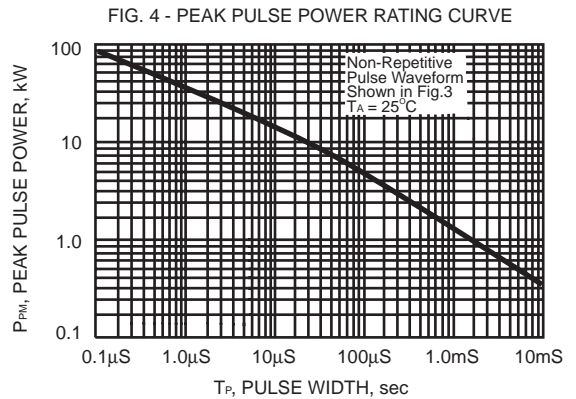
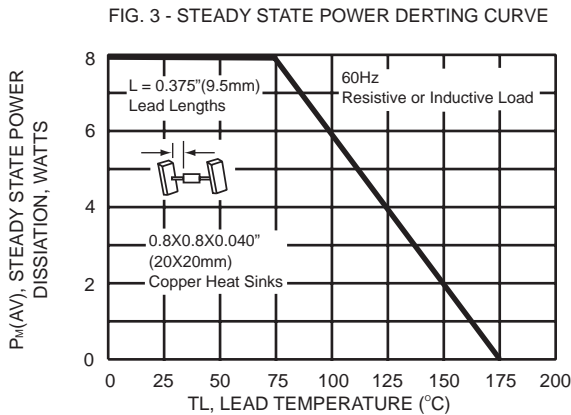
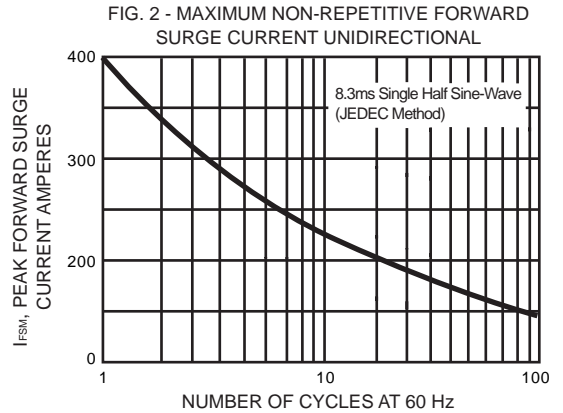
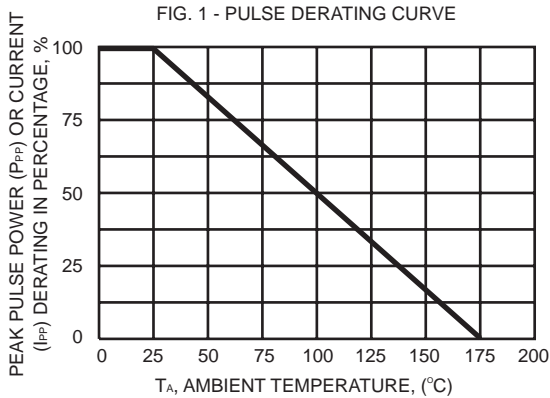

## SMDJ (3000W) SERIES TRANSIENT VOLTAGE SUPPRESSORS

TYPE	Reverse Stand-off Voltage	Breakdown Voltage @ I <sub>T</sub>		Test Current	Maximum Reverse Leakage @ V <sub>RWM</sub>		Maximum Clamping Voltage @ I <sub>PP</sub>	Maximum Peak Pulse Current	
		V <sub>BR</sub>			I <sub>T</sub>	I <sub>R</sub>			
		Min.	Max.			UNI-			BI-
	V <sub>RWM</sub>	V	V	mA	μA	μA	V <sub>C</sub>	I <sub>PP</sub>	
	V	V	V	mA	μA	μA	V	A	
SMDJ5.0	5.0	6.40	7.30	10	1000	2000	9.6	312.50	
SMDJ5.0A	5.0	6.40	7.00	10	1000	2000	9.2	326.09	
SMDJ6.0	6.0	6.67	8.15	10	1000	2000	11.4	263.16	
SMDJ6.0A	6.0	6.67	7.37	10	1000	2000	10.3	291.26	
SMDJ6.5	6.5	7.22	8.82	10	500	1000	12.3	243.90	
SMDJ6.5A	6.5	7.22	7.98	10	500	1000	11.2	267.86	
SMDJ7.0	7.0	7.78	9.51	10	200	400	13.3	225.56	
SMDJ7.0A	7.0	7.78	8.60	10	200	400	12.0	250.00	
SMDJ7.5	7.5	8.33	10.20	1	100	200	14.3	209.79	
SMDJ7.5A	7.5	8.33	9.21	1	100	100	15.0	232.56	
SMDJ8.0	8.0	8.89	10.90	1	50	100	15.0	200.00	
SMDJ8.0A	8.0	8.89	9.83	1	50	100	13.6	220.59	
SMDJ8.5	8.5	9.44	11.50	1	25	50	15.9	188.68	
SMDJ8.5A	8.5	9.44	10.40	1	25	50	14.4	208.33	
SMDJ9.0	9.0	10.00	12.20	1	10	20	16.9	177.51	
SMDJ9.0A	9.0	10.00	11.10	1	10	20	15.4	194.81	
SMDJ10	10	11.10	13.60	1	5	5	18.8	159.57	
SMDJ10A	10	11.10	12.30	1	5	5	17.0	176.47	
SMDJ11	11	12.20	14.90	1	5	5	20.1	149.25	
SMDJ11A	11	12.20	13.50	1	5	5	18.2	164.84	
SMDJ12	12	13.30	16.30	1	5	5	22.0	136.36	
SMDJ12A	12	13.30	14.70	1	5	5	19.9	150.75	
SMDJ13	13	14.40	17.60	1	5	5	23.8	126.05	
SMDJ13A	13	14.40	15.90	1	5	5	21.5	139.53	
SMDJ14	14	15.60	19.10	1	5	5	25.8	116.28	
SMDJ14A	14	15.60	17.20	1	5	5	23.2	129.31	
SMDJ15	15	16.70	20.40	1	5	5	26.9	111.52	
SMDJ15A	15	16.70	18.50	1	5	5	24.4	122.95	
SMDJ16	16	17.80	21.80	1	5	5	28.8	104.17	
SMDJ16A	16	17.80	19.70	1	5	5	26.0	115.38	
SMDJ17	17	18.90	23.10	1	5	5	30.5	98.36	
SMDJ17A	17	18.90	20.90	1	5	5	27.6	108.70	
SMDJ18	18	20.00	24.40	1	5	5	32.2	93.17	
SMDJ18A	18	20.00	22.10	1	5	5	29.2	102.74	
SMDJ19	19	21.13	25.76	1	5	5	34.0	88.21	
SMDJ19A	19	21.13	23.30	1	5	5	30.8	97.47	
SMDJ20	20	22.20	27.10	1	5	5	35.8	83.80	
SMDJ20A	20	22.20	24.50	1	5	5	32.4	92.59	
SMDJ22	22	24.40	29.80	1	5	5	39.4	76.14	
SMDJ22A	22	24.40	26.90	1	5	5	35.5	84.51	
SMDJ24	24	26.70	32.60	1	5	5	43.0	69.77	
SMDJ24A	24	26.70	29.50	1	5	5	38.9	77.12	
SMDJ26	26	28.90	35.30	1	5	5	46.6	64.38	
SMDJ26A	26	28.90	31.90	1	5	5	42.1	71.26	
SMDJ28	28	31.10	38.00	1	5	5	50.0	60.00	
SMDJ28A	28	31.10	34.40	1	5	5	45.4	66.08	
SMDJ30	30	33.30	40.70	1	5	5	53.5	56.07	
SMDJ30A	30	33.30	36.80	1	5	5	48.4	61.98	
SMDJ33	33	36.70	44.90	1	5	5	59.0	50.85	
SMDJ33A	33	36.70	40.60	1	5	5	53.3	56.29	
SMDJ36	36	40.00	48.90	1	5	5	64.3	46.66	
SMDJ36A	36	40.00	44.20	1	5	5	58.1	51.64	

## SMDJ (3000W) SERIES TRANSIENT VOLTAGE SUPPRESSORS

TYPE	Reverse Stand-off Voltage	Breakdown Voltage @ $I_T$		Test Current	Maximum Reverse Leakage @ $V_{RWM}$		Maximum Clamping Voltage @ $I_{PP}$	Maximum Peak Pulse Current
	$V_{RWM}$	$V_{BR}$		$I_T$	$I_R$		$V_C$	$I_{PP}$
		Min.	Max.		UNI-	BI-		
		V	V		$\mu A$	$\mu A$		
V	V	V	mA	$\mu A$	$\mu A$	V	A	
SMDJ40	40	44.40	54.30	1	5		71.4	42.02
SMDJ40A	40	44.40	49.10	1	5		64.5	46.51
SMDJ43	43	47.80	58.40	1	5		76.7	39.11
SMDJ43A	43	47.80	52.80	1	5		69.4	43.23
SMDJ45	45	50.00	61.10	1	5		80.3	37.36
SMDJ45A	45	50.00	55.30	1	5		72.7	41.27
SMDJ48	48	53.30	65.10	1	5		85.5	35.09
SMDJ48A	48	53.30	58.90	1	5		77.4	38.76
SMDJ51	51	56.70	69.30	1	5		91.1	32.93
SMDJ51A	51	56.70	62.70	1	5		82.4	36.41
SMDJ54	54	60.00	73.30	1	5		96.3	31.15
SMDJ54A	54	60.00	66.30	1	5		87.1	34.44
SMDJ58	58	64.40	78.70	1	5		103	29.13
SMDJ58A	58	64.40	71.20	1	5		93.6	32.05
SMDJ60	60	66.70	81.50	1	5		107	28.04
SMDJ60A	60	66.70	73.70	1	5		96.8	30.99
SMDJ64	64	71.10	86.90	1	5		114	26.32
SMDJ64A	64	71.70	78.60	1	5		103	29.13
SMDJ70	70	77.80	95.10	1	5		125	24.00
SMDJ70A	70	77.80	86.00	1	5		113	26.55
SMDJ75	75	83.30	102	1	5		134	22.39
SMDJ75A	75	83.30	92.10	1	5		121	24.79
SMDJ78	78	86.70	106	1	5		139	21.58
SMDJ78A	78	86.70	95.80	1	5		126	23.81
SMDJ80	80	88.80	108	1	5		143.2	20.95
SMDJ80A	80	88.80	97.60	1	5		129.6	21.15
SMDJ85	85	94.40	115	1	5		151	19.87
SMDJ85A	85	94.40	104	1	5		137	21.90
SMDJ90	90	100	122	1	5		160	18.75
SMDJ90A	90	100	111	1	5		146	20.55
SMDJ100	100	111	136	1	5		179	16.76
SMDJ100A	100	111	123	1	5		162	18.52
SMDJ110	110	122	149	1	5		196	15.31
SMDJ110A	110	122	135	1	5		177	16.95
SMDJ120	120	133	163	1	5		214	14.02
SMDJ120A	120	133	147	1	5		193	15.54
SMDJ130	130	144	176	1	5		231	12.99
SMDJ130A	130	144	159	1	5		209	14.35
SMDJ140	140	155	190.4	1	5		250.6	11.97
SMDJ140A	140	155	171	1	5		226.8	13.23
SMDJ150	150	167	204	1	5		268	11.19
SMDJ150A	150	167	185	1	5		243	12.35
SMDJ160	160	178	218	1	5		287	10.45
SMDJ160A	160	178	197	1	5		259	11.58
SMDJ170	170	189	231	1	5		304	9.87
SMDJ170A	170	189	209	1	5		275	10.91
SMDJ180	180	200	244.8	1	5		322.2	9.31
SMDJ180A	180	200	220	1	5		291.6	10.29
SMDJ190	190	211	258.4	1	5		340.1	8.82
SMDJ190A	190	211	232	1	5		307.8	9.75

## SMDJ (3000W) SERIES TRANSIENT VOLTAGE SUPPRESSORS

TYPE	Reverse Stand-off Voltage	Breakdown Voltage @ I <sub>T</sub>		Test Current	Maximum Reverse Leakage @ V <sub>RWM</sub>		Maximum Clamping Voltage @ I <sub>PP</sub>	Maximum Peak Pulse Current
					I <sub>R</sub>			
	V <sub>RWM</sub>	V <sub>BR</sub>		I <sub>T</sub>	UNI-	BI-	V <sub>C</sub>	I <sub>PP</sub>
		Min.	Max.		μA	μA		
V	V	V	mA	μA	μA	V	A	
SMDJ200A	200	224	247	1	5		324	9.26
SMDJ220A	220	246	272	1	5		356	8.43
SMDJ250A	250	279	309	1	5		405	7.41
SMDJ300A	300	335	371	1	5		486	6.17
SMDJ350A	350	391	432	1	5		567	5.29
SMDJ400A	400	447	494	1	5		648	4.63
SMDJ440A	440	492	534	1	5		713	4.21

NOTES: 1. V<sub>BR</sub> measured after I<sub>T</sub> applied for 300μs. I<sub>T</sub>= Square Wave Pulse or equivalent.

2. For bidirectional use "C" or "CA" suffixes for all types (e.g.: SMDJ5.0C, SMDJ5.0CA, SMDJ440C, SMDJ440CA).  
Electrical characteristics apply in both directions.

3. For bidirectional types having V<sub>RWM</sub> of 10 volts and less, the I<sub>D</sub> limit is doubled.

## Disclaimer

Any Customer or user of this document or products described herein in such applications shall assume all risks of such use and will agree to hold *DC COMPONENTS* harmless against all damages.

*DC COMPONENTS* disclaims any and all liability arising out of the application or use of any product, including consequential or incidental damages. Statement regarding the suitability of products for certain types of applications are based on *DC COMPONENTS*'s knowledge of typical requirements that are often placed on *DC COMPONENTS* products in generic applications. Such statements are not binding statements about the suitability of products for a particular application. It is the customer's responsibility to validate that a particular product with the properties described in the product specification is suitable for use in a particular application.

*DC COMPONENTS* reserve the right to make modifications, enhancements, improvements, corrections or other changes without further notice to this document and any product described herein, and disclaim any and all liability for any errors, inaccuracies or incompleteness contained in any datasheet or in any other disclosure relating to any product. Parameters provided in datasheets and specifications may vary in different applications and performance may vary over time. All operating parameters, including typical parameters, must be validated for each customer application by the customer's technical experts. Product specifications do not expand or otherwise modify *DC COMPONENTS*'s terms and conditions of purchase, including but not limited to the warranty expressed therein.

Unless otherwise in writing, *DC COMPONENTS* products are intended for use as general electronic components in standard applications ( eg: Consumer electronic, Computer equipment, Office equipment, etc.), and not recommended for use in a high specific application where a failure or malfunction of the device could result in human injury or death ( eg: Aerospace equipment, Submarine cables, Combustion equipment, Safety devices, Life support systems, etc.)

Customers using or selling *DC COMPONENTS* products not expressly indicated for use in such applications do so at their own risk. If customer intended to use *DC COMPONENTS* standard quality grade devices for applications not envisioned by *DC COMPONENTS*, please contact our sales representatives in advance.



*DC COMPONENTS CO., LTD.*