

MUN5213DW1, NSBC144EDXV6, NSBC144EDP6

Dual NPN Bias Resistor Transistors

R1 = 47 kΩ, R2 = 47 kΩ

NPN Transistors with Monolithic Bias Resistor Network

This series of digital transistors is designed to replace a single device and its external resistor bias network. The Bias Resistor Transistor (BRT) contains a single transistor with a monolithic bias network consisting of two resistors; a series base resistor and a base-emitter resistor. The BRT eliminates these individual components by integrating them into a single device. The use of a BRT can reduce both system cost and board space.

Features

- Simplifies Circuit Design
- Reduces Board Space
- Reduces Component Count
- S and NSV Prefix for Automotive and Other Applications Requiring Unique Site and Control Change Requirements; AEC-Q101 Qualified and PPAP Capable*
- These Devices are Pb-Free, Halogen Free/BFR Free and are RoHS Compliant

MAXIMUM RATINGS

(T_A = 25°C, common for Q₁ and Q₂, unless otherwise noted)

Rating	Symbol	Max	Unit
Collector-Base Voltage	V _{CBO}	50	Vdc
Collector-Emitter Voltage	V _{CEO}	50	Vdc
Collector Current – Continuous	I _C	100	mAdc
Input Forward Voltage	V _{IN(fwd)}	40	Vdc
Input Reverse Voltage	V _{IN(rev)}	10	Vdc

Stresses exceeding those listed in the Maximum Ratings table may damage the device. If any of these limits are exceeded, device functionality should not be assumed, damage may occur and reliability may be affected.

ORDERING INFORMATION

Device	Package	Shipping†
MUN5213DW1T1G, SMUN5213DW1T1G*	SOT-363	3,000 / Tape & Reel
MUN5213DW1T3G, NSVMUN5213DW1T3G*	SOT-363	10,000 / Tape & Reel
NSBC144EDXV6T1G	SOT-563	4,000 / Tape & Reel
NSBC144EDXV6T5G	SOT-563	8,000 / Tape & Reel
NSBC144EDP6T5G	SOT-963	8,000 / Tape & Reel

†For information on tape and reel specifications, including part orientation and tape sizes, please refer to our Tape and Reel Packaging Specifications Brochure, BRD8011/D.



ON Semiconductor®

www.onsemi.com

PIN CONNECTIONS

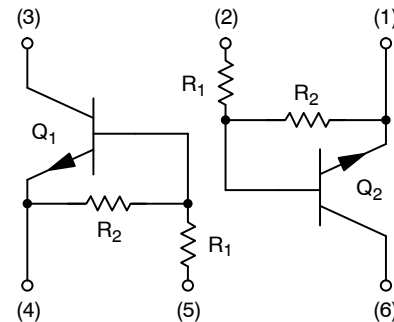

MARKING DIAGRAMS

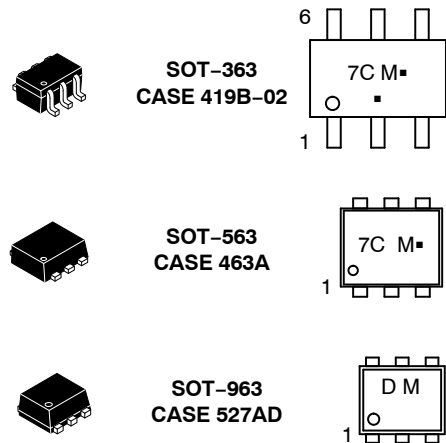

7C/D = Specific Device Code
M = Date Code*
■ = Pb-Free Package

(Note: Microdot may be in either location)

*Date Code orientation may vary depending upon manufacturing location.

MUN5213DW1, NSBC144EDXV6, NSBC144EDP6

THERMAL CHARACTERISTICS

Characteristic	Symbol	Max	Unit
----------------	--------	-----	------

MUN5213DW1 (SOT-363) ONE JUNCTION HEATED

Total Device Dissipation $T_A = 25^\circ\text{C}$ (Note 13) (Note 14) Derate above 25°C (Note 13) (Note 14)	P_D	187 256 1.5 2.0	mW mW/ $^\circ\text{C}$
Thermal Resistance, Junction to Ambient (Note 13) (Note 14)	$R_{\theta JA}$	670 490	$^\circ\text{C/W}$

MUN5213DW1 (SOT-363) BOTH JUNCTION HEATED (Note 15)

Total Device Dissipation $T_A = 25^\circ\text{C}$ (Note 13) (Note 14) Derate above 25°C (Note 13) (Note 14)	P_D	250 385 2.0 3.0	mW mW/ $^\circ\text{C}$
Thermal Resistance, Junction to Ambient (Note 13) (Note 14)	$R_{\theta JA}$	493 325	$^\circ\text{C/W}$
Thermal Resistance, Junction to Lead (Note 13) (Note 14)	$R_{\theta JL}$	188 208	$^\circ\text{C/W}$
Junction and Storage Temperature Range	T_J, T_{stg}	-55 to +150	$^\circ\text{C}$

NSBC144EDXV6 (SOT-563) ONE JUNCTION HEATED

Total Device Dissipation $T_A = 25^\circ\text{C}$ (Note 13) Derate above 25°C (Note 13)	P_D	357 2.9	mW mW/ $^\circ\text{C}$
Thermal Resistance, Junction to Ambient (Note 13)	$R_{\theta JA}$	350	$^\circ\text{C/W}$

NSBC144EDXV6 (SOT-563) BOTH JUNCTION HEATED (Note 15)

Total Device Dissipation $T_A = 25^\circ\text{C}$ (Note 13) Derate above 25°C (Note 13)	P_D	500 4.0	mW mW/ $^\circ\text{C}$
Thermal Resistance, Junction to Ambient (Note 13)	$R_{\theta JA}$	250	$^\circ\text{C/W}$
Junction and Storage Temperature Range	T_J, T_{stg}	-55 to +150	$^\circ\text{C}$

NSBC144EDP6 (SOT-963) ONE JUNCTION HEATED

Total Device Dissipation $T_A = 25^\circ\text{C}$ (Note 16) (Note 17) Derate above 25°C (Note 16) (Note 17)	P_D	231 269 1.9 2.2	MW mW/ $^\circ\text{C}$
Thermal Resistance, Junction to Ambient (Note 16) (Note 17)	$R_{\theta JA}$	540 464	$^\circ\text{C/W}$

NSBC144EDP6 (SOT-963) BOTH JUNCTION HEATED (Note 15)

Total Device Dissipation $T_A = 25^\circ\text{C}$ (Note 16) (Note 17) Derate above 25°C (Note 16) (Note 17)	P_D	339 408 2.7 3.3	MW mW/ $^\circ\text{C}$
Thermal Resistance, Junction to Ambient (Note 16) (Note 17)	$R_{\theta JA}$	369 306	$^\circ\text{C/W}$
Junction and Storage Temperature Range	T_J, T_{stg}	-55 to +150	$^\circ\text{C}$

13. FR-4 @ Minimum Pad.

14. FR-4 @ 1.0 x 1.0 Inch Pad.

15. Both junction heated values assume total power is sum of two equally powered channels.

16. FR-4 @ 100 mm², 1 oz. copper traces, still air.

17. FR-4 @ 500 mm², 1 oz. copper traces, still air.

MUN5213DW1, NSBC144EDXV6, NSBC144EDP6

ELECTRICAL CHARACTERISTICS (T_A = 25°C, common for Q₁ and Q₂, unless otherwise noted)

Characteristic	Symbol	Min	Typ	Max	Unit
OFF CHARACTERISTICS					
Collector-Base Cutoff Current (V _{CB} = 50 V, I _E = 0)	I _{CBO}	-	-	100	nAdc
Collector-Emitter Cutoff Current (V _{CE} = 50 V, I _B = 0)	I _{CEO}	-	-	500	nAdc
Emitter-Base Cutoff Current (V _{EB} = 6.0 V, I _C = 0)	I _{EBO}	-	-	0.1	mAdc
Collector-Base Breakdown Voltage (I _C = 10 μA, I _E = 0)	V _{(BR)CBO}	50	-	-	Vdc
Collector-Emitter Breakdown Voltage (Note 18) (I _C = 2.0 mA, I _B = 0)	V _{(BR)CEO}	50	-	-	Vdc

ON CHARACTERISTICS

DC Current Gain (Note 18) (I _C = 5.0 mA, V _{CE} = 10 V)	h _{FE}	80	140	-	
Collector-Emitter Saturation Voltage (Note 18) (I _C = 10 mA, I _B = 0.3 mA)	V _{CE(sat)}	-	-	0.25	V
Input Voltage (Off) (V _{CE} = 5.0 V, I _C = 100 μA)	V _{i(off)}	-	1.2	-	Vdc
Input Voltage (On) (V _{CE} = 0.2 V, I _C = 3.0 mA)	V _{i(on)}	-	1.9	-	Vdc
Output Voltage (On) (V _{CC} = 5.0 V, V _B = 3.5 V, R _L = 1.0 kΩ)	V _{OL}	-	-	0.2	Vdc
Output Voltage (Off) (V _{CC} = 5.0 V, V _B = 0.5 V, R _L = 1.0 kΩ)	V _{OH}	4.9	-	-	Vdc
Input Resistor	R ₁	32.9	47	61.1	kΩ
Resistor Ratio	R ₁ /R ₂	0.8	1.0	1.2	

18. Pulsed Condition: Pulse Width = 300 ms, Duty Cycle ≤ 2%.

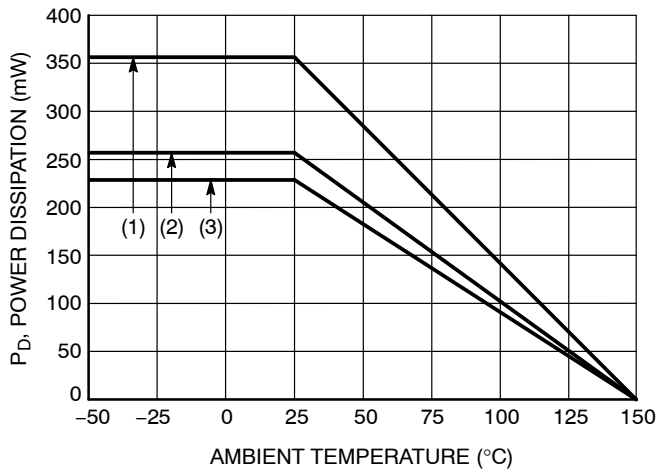

- (1) SOT-363; 1.0 × 1.0 Inch Pad
- (2) SOT-563; Minimum Pad
- (3) SOT-963; 100 mm², 1 oz. Copper Trace

Figure 33. Derating Curve

TYPICAL CHARACTERISTICS
MUN5213DW1, NSBC144EDXV6

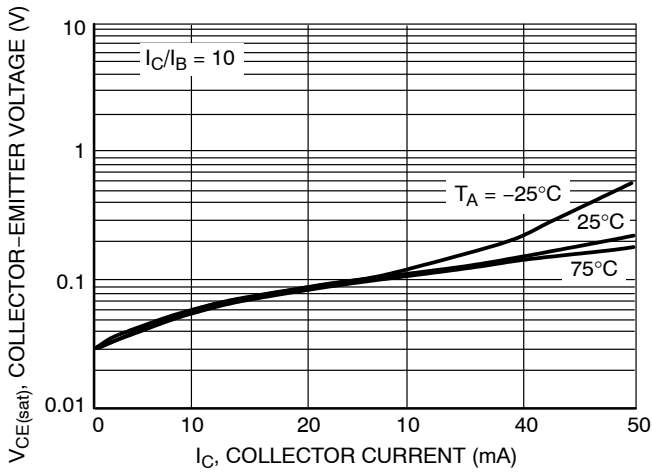

Figure 34. $V_{CE(sat)}$ vs. I_C

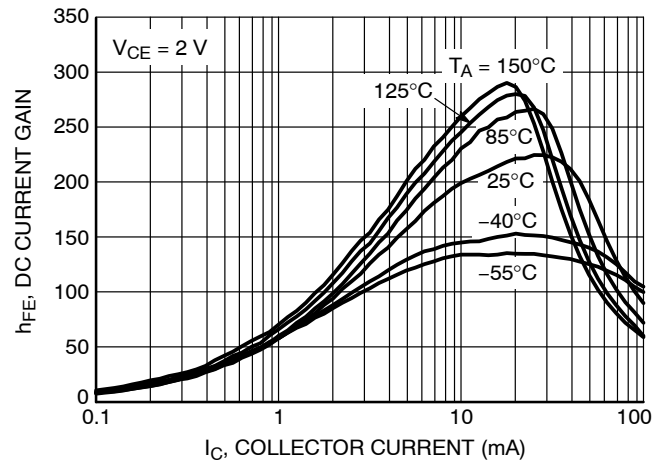

Figure 35. DC Current Gain

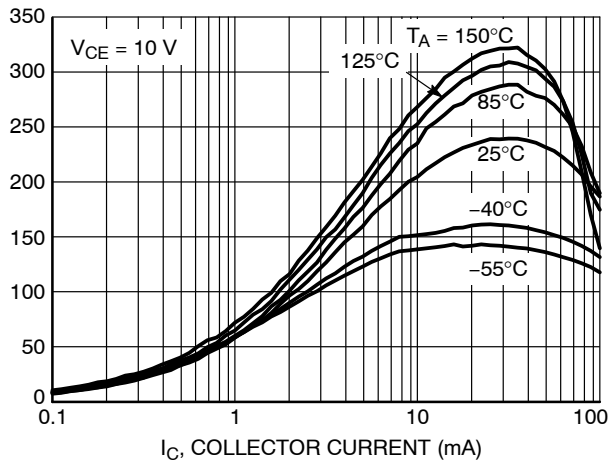

Figure 36. DC Current Gain

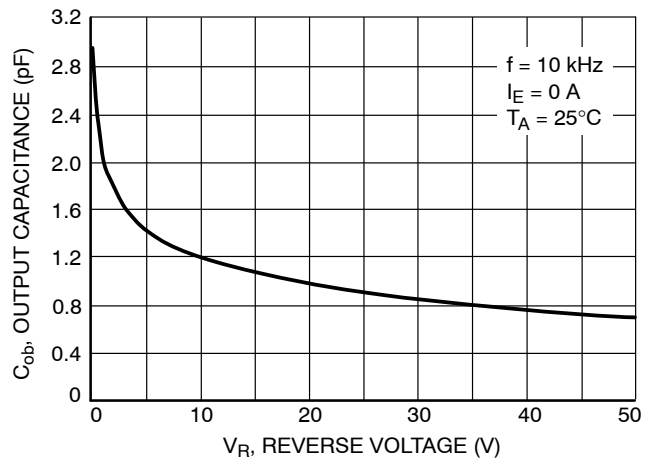

Figure 37. Output Capacitance

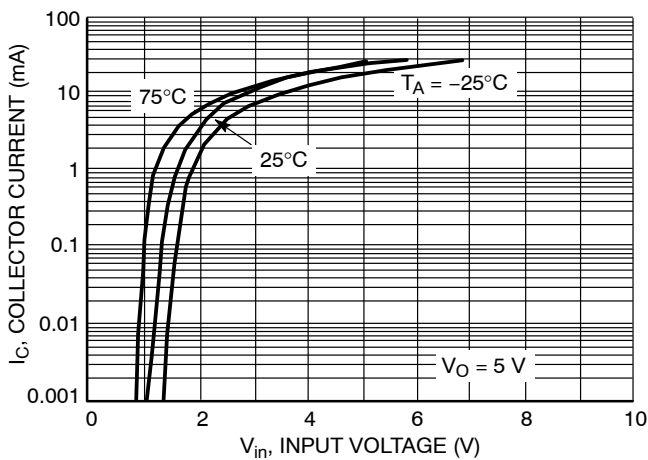

Figure 38. Output Current vs. Input Voltage

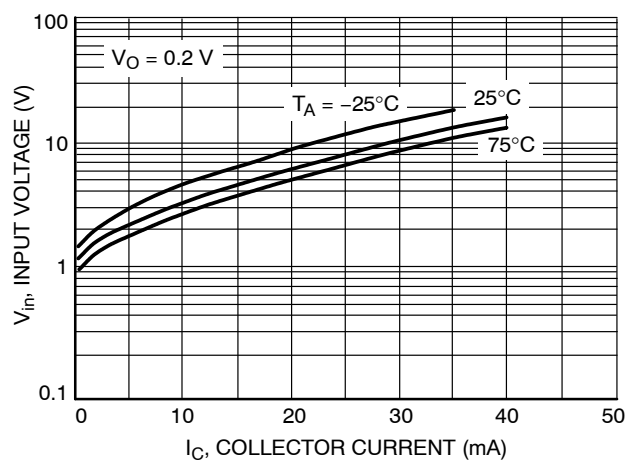

Figure 39. Input Voltage vs. Output Current

TYPICAL CHARACTERISTICS
NSBC144EDP6

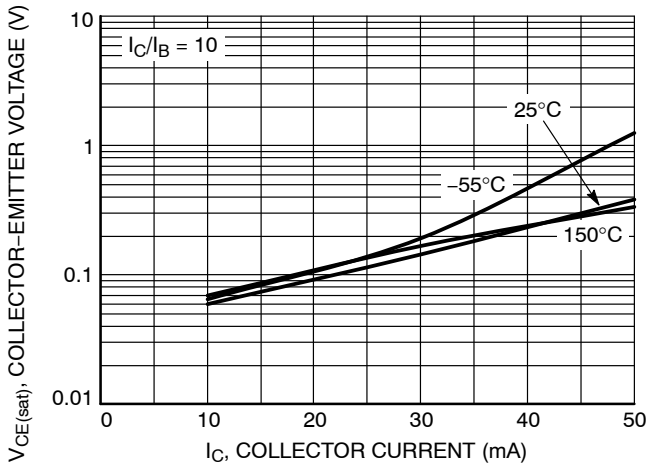

Figure 40. $V_{CE(sat)}$ vs. I_C

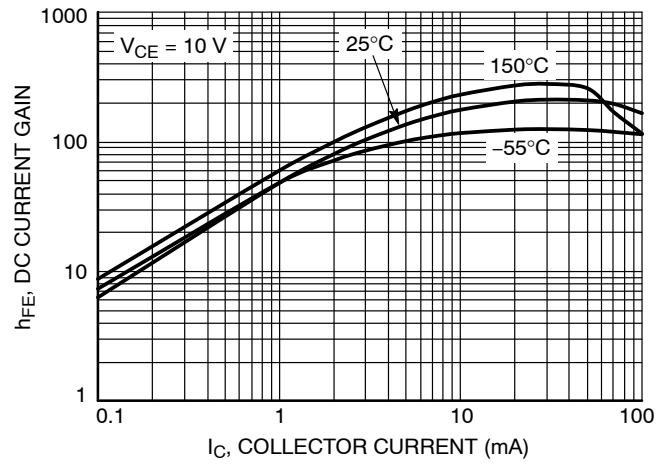

Figure 41. DC Current Gain

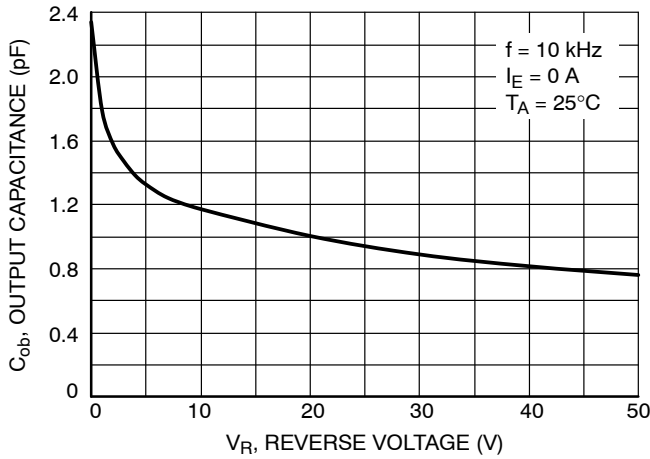

Figure 42. Output Capacitance

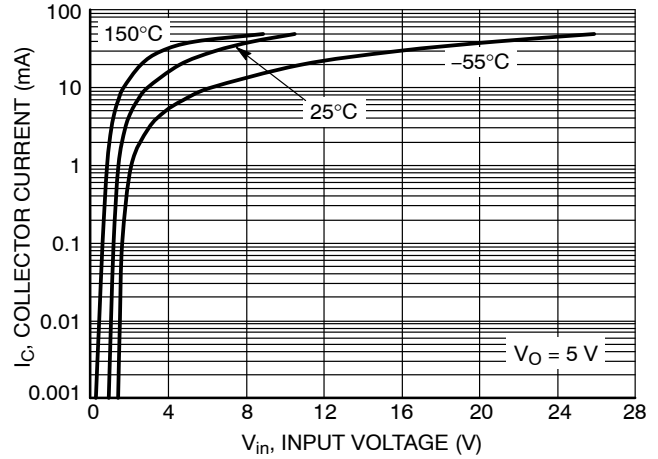

Figure 43. Output Current vs. Input Voltage

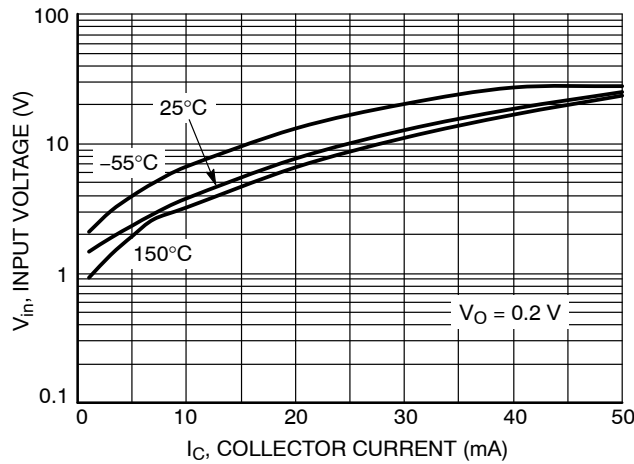

Figure 44. Input Voltage vs. Output Current



1
 SCALE 2:1

SC-88/SC70-6/SOT-363
 CASE 419B-02
 ISSUE Y

DATE 11 DEC 2012

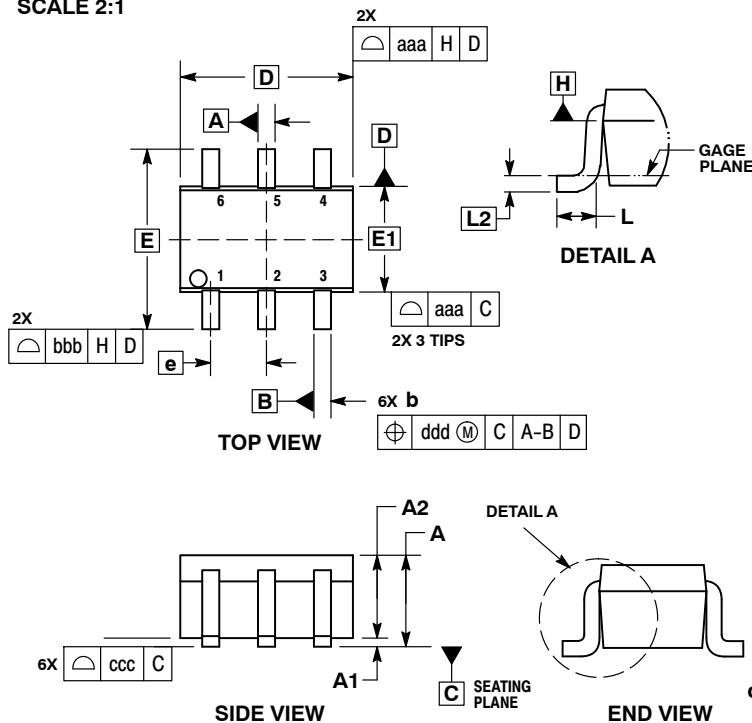

- NOTES:
1. DIMENSIONING AND TOLERANCING PER ASME Y14.5M, 1994.
 2. CONTROLLING DIMENSION: MILLIMETERS.
 3. DIMENSIONS D AND E1 DO NOT INCLUDE MOLD FLASH, PROTRUSIONS, OR GATE BURRS. MOLD FLASH, PROTRUSIONS, OR GATE BURRS SHALL NOT EXCEED 0.20 PER END.
 4. DIMENSIONS D AND E1 AT THE OUTERMOST EXTREMES OF THE PLASTIC BODY AND DATUM H.
 5. DATUMS A AND B ARE DETERMINED AT DATUM H.
 6. DIMENSIONS b AND c APPLY TO THE FLAT SECTION OF THE LEAD BETWEEN 0.08 AND 0.15 FROM THE TIP.
 7. DIMENSION b DOES NOT INCLUDE DAMBAR PROTRUSION. ALLOWABLE DAMBAR PROTRUSION SHALL BE 0.08 TOTAL IN EXCESS OF DIMENSION b AT MAXIMUM MATERIAL CONDITION. THE DAMBAR CANNOT BE LOCATED ON THE LOWER RADIUS OF THE FOOT.

DIM	MILLIMETERS			INCHES		
	MIN	NOM	MAX	MIN	NOM	MAX
A	---	---	1.10	---	---	0.043
A1	0.00	---	0.10	0.000	---	0.004
A2	0.70	0.90	1.00	0.027	0.035	0.039
b	0.15	0.20	0.25	0.006	0.008	0.010
C	0.08	0.15	0.22	0.003	0.006	0.009
D	1.80	2.00	2.20	0.070	0.078	0.086
E	2.00	2.10	2.20	0.078	0.082	0.086
E1	1.15	1.25	1.35	0.045	0.049	0.053
e	0.65 BSC			0.026 BSC		
L	0.26	0.36	0.46	0.010	0.014	0.018
L2	0.15 BSC			0.006 BSC		
aaa	0.15			0.006		
bbb	0.30			0.012		
ccc	0.10			0.004		
ddd	0.10			0.004		

GENERIC MARKING DIAGRAM*

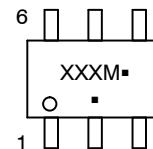

- XXX = Specific Device Code
- M = Date Code*
- = Pb-Free Package

(Note: Microdot may be in either location)

*Date Code orientation and/or position may vary depending upon manufacturing location.

*This information is generic. Please refer to device data sheet for actual part marking. Pb-Free indicator, "G" or microdot "▪", may or may not be present.

RECOMMENDED SOLDERING FOOTPRINT*

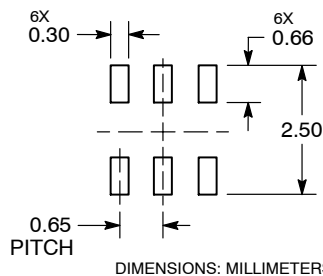

*For additional information on our Pb-Free strategy and soldering details, please download the ON Semiconductor Soldering and Mounting Techniques Reference Manual, SOLDERRM/D.

STYLES ON PAGE 2

DOCUMENT NUMBER:	98ASB42985B	Electronic versions are uncontrolled except when accessed directly from the Document Repository. Printed versions are uncontrolled except when stamped "CONTROLLED COPY" in red.
DESCRIPTION:	SC-88/SC70-6/SOT-363	PAGE 1 OF 2

ON Semiconductor and ON are trademarks of Semiconductor Components Industries, LLC dba ON Semiconductor or its subsidiaries in the United States and/or other countries. ON Semiconductor reserves the right to make changes without further notice to any products herein. ON Semiconductor makes no warranty, representation or guarantee regarding the suitability of its products for any particular purpose, nor does ON Semiconductor assume any liability arising out of the application or use of any product or circuit, and specifically disclaims any and all liability, including without limitation special, consequential or incidental damages. ON Semiconductor does not convey any license under its patent rights nor the rights of others.

SC-88/SC70-6/SOT-363
CASE 419B-02
ISSUE Y

DATE 11 DEC 2012

STYLE 1: PIN 1. EMITTER 2 2. BASE 2 3. COLLECTOR 1 4. EMITTER 1 5. BASE 1 6. COLLECTOR 2	STYLE 2: CANCELLED	STYLE 3: CANCELLED	STYLE 4: PIN 1. CATHODE 2. CATHODE 3. COLLECTOR 4. EMITTER 5. BASE 6. ANODE	STYLE 5: PIN 1. ANODE 2. ANODE 3. COLLECTOR 4. EMITTER 5. BASE 6. CATHODE	STYLE 6: PIN 1. ANODE 2 2. N/C 3. CATHODE 1 4. ANODE 1 5. N/C 6. CATHODE 2
STYLE 7: PIN 1. SOURCE 2 2. DRAIN 2 3. GATE 1 4. SOURCE 1 5. DRAIN 1 6. GATE 2	STYLE 8: CANCELLED	STYLE 9: PIN 1. EMITTER 2 2. EMITTER 1 3. COLLECTOR 1 4. BASE 1 5. BASE 2 6. COLLECTOR 2	STYLE 10: PIN 1. SOURCE 2 2. SOURCE 1 3. GATE 1 4. DRAIN 1 5. DRAIN 2 6. GATE 2	STYLE 11: PIN 1. CATHODE 2 2. CATHODE 2 3. ANODE 1 4. CATHODE 1 5. CATHODE 1 6. ANODE 2	STYLE 12: PIN 1. ANODE 2 2. ANODE 2 3. CATHODE 1 4. ANODE 1 5. ANODE 1 6. CATHODE 2
STYLE 13: PIN 1. ANODE 2. N/C 3. COLLECTOR 4. EMITTER 5. BASE 6. CATHODE	STYLE 14: PIN 1. VREF 2. GND 3. GND 4. IOUT 5. VEN 6. VCC	STYLE 15: PIN 1. ANODE 1 2. ANODE 2 3. ANODE 3 4. CATHODE 3 5. CATHODE 2 6. CATHODE 1	STYLE 16: PIN 1. BASE 1 2. EMITTER 2 3. COLLECTOR 2 4. BASE 2 5. EMITTER 1 6. COLLECTOR 1	STYLE 17: PIN 1. BASE 1 2. EMITTER 1 3. COLLECTOR 2 4. BASE 2 5. EMITTER 2 6. COLLECTOR 1	STYLE 18: PIN 1. VIN1 2. VCC 3. VOUT2 4. VIN2 5. GND 6. VOUT1
STYLE 19: PIN 1. IOUT 2. GND 3. GND 4. V CC 5. V EN 6. V REF	STYLE 20: PIN 1. COLLECTOR 2. COLLECTOR 3. BASE 4. EMITTER 5. COLLECTOR 6. COLLECTOR	STYLE 21: PIN 1. ANODE 1 2. N/C 3. ANODE 2 4. CATHODE 2 5. N/C 6. CATHODE 1	STYLE 22: PIN 1. D1 (i) 2. GND 3. D2 (j) 4. D2 (c) 5. VBUS 6. D1 (c)	STYLE 23: PIN 1. Vn 2. CH1 3. Vp 4. N/C 5. CH2 6. N/C	STYLE 24: PIN 1. CATHODE 2. ANODE 3. CATHODE 4. CATHODE 5. CATHODE 6. CATHODE
STYLE 25: PIN 1. BASE 1 2. CATHODE 3. COLLECTOR 2 4. BASE 2 5. EMITTER 6. COLLECTOR 1	STYLE 26: PIN 1. SOURCE 1 2. GATE 1 3. DRAIN 2 4. SOURCE 2 5. GATE 2 6. DRAIN 1	STYLE 27: PIN 1. BASE 2 2. BASE 1 3. COLLECTOR 1 4. EMITTER 1 5. EMITTER 2 6. COLLECTOR 2	STYLE 28: PIN 1. DRAIN 2. DRAIN 3. GATE 4. SOURCE 5. DRAIN 6. DRAIN	STYLE 29: PIN 1. ANODE 2. ANODE 3. COLLECTOR 4. EMITTER 5. BASE/ANODE 6. CATHODE	STYLE 30: PIN 1. SOURCE 1 2. DRAIN 2 3. DRAIN 2 4. SOURCE 2 5. GATE 1 6. DRAIN 1

DOCUMENT NUMBER:	98ASB42985B	Electronic versions are uncontrolled except when accessed directly from the Document Repository. Printed versions are uncontrolled except when stamped "CONTROLLED COPY" in red.
DESCRIPTION:	SC-88/SC70-6/SOT-363	PAGE 2 OF 2

ON Semiconductor and  are trademarks of Semiconductor Components Industries, LLC dba ON Semiconductor or its subsidiaries in the United States and/or other countries. ON Semiconductor reserves the right to make changes without further notice to any products herein. ON Semiconductor makes no warranty, representation or guarantee regarding the suitability of its products for any particular purpose, nor does ON Semiconductor assume any liability arising out of the application or use of any product or circuit, and specifically disclaims any and all liability, including without limitation special, consequential or incidental damages. ON Semiconductor does not convey any license under its patent rights nor the rights of others.

MECHANICAL CASE OUTLINE

PACKAGE DIMENSIONS

ON Semiconductor®



SCALE 4:1

SOT-563, 6 LEAD CASE 463A ISSUE G

DATE 23 SEP 2015

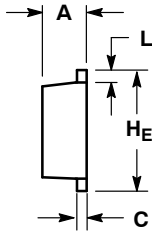
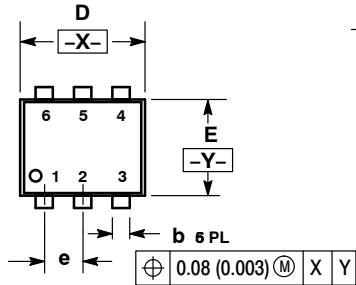

NOTES:

1. DIMENSIONING AND TOLERANCING PER ANSI Y14.5M, 1982.
2. CONTROLLING DIMENSION: MILLIMETERS
3. MAXIMUM LEAD THICKNESS INCLUDES LEAD FINISH THICKNESS. MINIMUM LEAD THICKNESS IS THE MINIMUM THICKNESS OF BASE MATERIAL.

DIM	MILLIMETERS			INCHES		
	MIN	NOM	MAX	MIN	NOM	MAX
A	0.50	0.55	0.60	0.020	0.021	0.023
b	0.17	0.22	0.27	0.007	0.009	0.011
C	0.08	0.12	0.18	0.003	0.005	0.007
D	1.50	1.60	1.70	0.059	0.062	0.066
E	1.10	1.20	1.30	0.043	0.047	0.051
e	0.5 BSC			0.02 BSC		
L	0.10	0.20	0.30	0.004	0.008	0.012
H _E	1.50	1.60	1.70	0.059	0.062	0.066

GENERIC MARKING DIAGRAM*

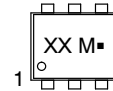

XX = Specific Device Code
M = Month Code
▪ = Pb-Free Package

*This information is generic. Please refer to device data sheet for actual part marking. Pb-Free indicator, "G" or microdot "▪", may or may not be present.

- | | | |
|---|---|---|
| <p>STYLE 1:
PIN 1. EMITTER 1
2. BASE 1
3. COLLECTOR 2
4. EMITTER 2
5. BASE 2
6. COLLECTOR 1</p> | <p>STYLE 2:
PIN 1. EMITTER 1
2. EMITTER 2
3. BASE 2
4. COLLECTOR 2
5. BASE 1
6. COLLECTOR 1</p> | <p>STYLE 3:
PIN 1. CATHODE 1
2. CATHODE 1
3. ANODE/ANODE 2
4. CATHODE 2
5. CATHODE 2
6. ANODE/ANODE 1</p> |
| <p>STYLE 4:
PIN 1. COLLECTOR
2. COLLECTOR
3. BASE
4. EMITTER
5. COLLECTOR
6. COLLECTOR</p> | <p>STYLE 5:
PIN 1. CATHODE
2. CATHODE
3. ANODE
4. ANODE
5. CATHODE
6. CATHODE</p> | <p>STYLE 6:
PIN 1. CATHODE
2. ANODE
3. CATHODE
4. CATHODE
5. CATHODE
6. CATHODE</p> |
| <p>STYLE 7:
PIN 1. CATHODE
2. ANODE
3. CATHODE
4. CATHODE
5. ANODE
6. CATHODE</p> | <p>STYLE 8:
PIN 1. DRAIN
2. DRAIN
3. GATE
4. SOURCE
5. DRAIN
6. DRAIN</p> | <p>STYLE 9:
PIN 1. SOURCE 1
2. GATE 1
3. DRAIN 2
4. SOURCE 2
5. GATE 2
6. DRAIN 1</p> |
| <p>STYLE 10:
PIN 1. CATHODE 1
2. N/C
3. CATHODE 2
4. ANODE 2
5. N/C
6. ANODE 1</p> | | |

SOLDERING FOOTPRINT*

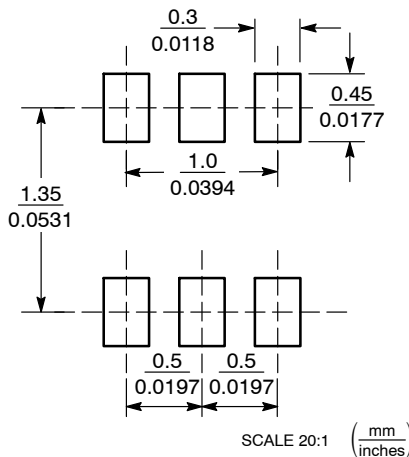

*For additional information on our Pb-Free strategy and soldering details, please download the ON Semiconductor Soldering and Mounting Techniques Reference Manual, SOLDERRM/D.

DOCUMENT NUMBER:	98AON11126D	Electronic versions are uncontrolled except when accessed directly from the Document Repository. Printed versions are uncontrolled except when stamped "CONTROLLED COPY" in red.
DESCRIPTION:	SOT-563, 6 LEAD	PAGE 1 OF 1

ON Semiconductor and ON are trademarks of Semiconductor Components Industries, LLC dba ON Semiconductor or its subsidiaries in the United States and/or other countries. ON Semiconductor reserves the right to make changes without further notice to any products herein. ON Semiconductor makes no warranty, representation or guarantee regarding the suitability of its products for any particular purpose, nor does ON Semiconductor assume any liability arising out of the application or use of any product or circuit, and specifically disclaims any and all liability, including without limitation special, consequential or incidental damages. ON Semiconductor does not convey any license under its patent rights nor the rights of others.

MECHANICAL CASE OUTLINE

PACKAGE DIMENSIONS

ON Semiconductor®



SCALE 4:1

SOT-963
CASE 527AD-01
ISSUE E

DATE 09 FEB 2010

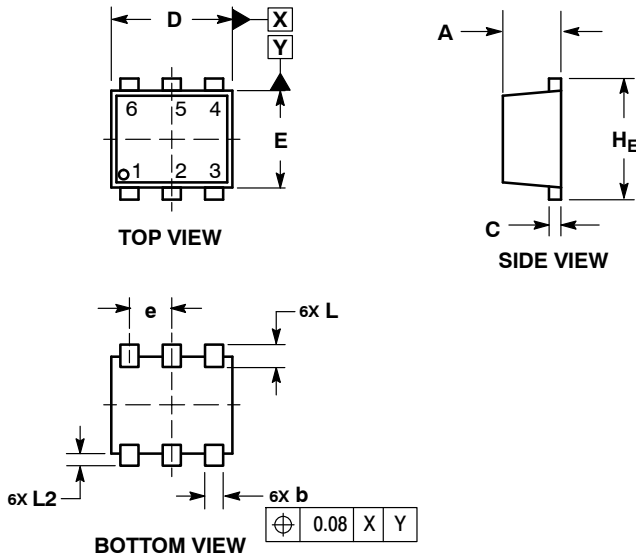

- NOTES:
1. DIMENSIONING AND TOLERANCING PER ASME Y14.5M, 1994.
 2. CONTROLLING DIMENSION: MILLIMETERS
 3. MAXIMUM LEAD THICKNESS INCLUDES LEAD FINISH THICKNESS. MINIMUM LEAD THICKNESS IS THE MINIMUM THICKNESS OF BASE MATERIAL.
 4. DIMENSIONS D AND E DO NOT INCLUDE MOLD FLASH, PROTRUSIONS, OR GATE BURRS.

MILLIMETERS			
DIM	MIN	NOM	MAX
A	0.34	0.37	0.40
b	0.10	0.15	0.20
C	0.07	0.12	0.17
D	0.95	1.00	1.05
E	0.75	0.80	0.85
e	0.35 BSC		
H _E	0.95	1.00	1.05
L	0.19 REF		
L2	0.05	0.10	0.15

GENERIC MARKING DIAGRAM*

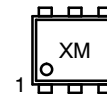

X = Specific Device Code
M = Month Code

*This information is generic. Please refer to device data sheet for actual part marking.
Pb-Free indicator, "G" or microdot "•", may or may not be present.

RECOMMENDED MOUNTING FOOTPRINT

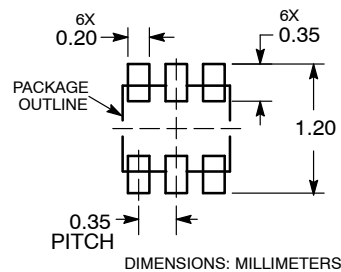

- STYLE 1:**
PIN 1. EMITTER 1
2. BASE 1
3. COLLECTOR 2
4. EMITTER 2
5. BASE 2
6. COLLECTOR 1
- STYLE 2:**
PIN 1. EMITTER 1
2. EMITTER2
3. BASE 2
4. COLLECTOR 2
5. BASE 1
6. COLLECTOR 1
- STYLE 3:**
PIN 1. CATHODE 1
2. CATHODE 1
3. ANODE/ANODE 2
4. CATHODE 2
5. CATHODE 2
6. ANODE/ANODE 1
- STYLE 4:**
PIN 1. COLLECTOR
2. COLLECTOR
3. BASE
4. EMITTER
5. COLLECTOR
6. COLLECTOR
- STYLE 5:**
PIN 1. CATHODE
2. CATHODE
3. ANODE
4. ANODE
5. CATHODE
6. CATHODE
- STYLE 6:**
PIN 1. CATHODE
2. ANODE
3. CATHODE
4. CATHODE
5. CATHODE
6. CATHODE
- STYLE 7:**
PIN 1. CATHODE
2. ANODE
3. CATHODE
4. CATHODE
5. ANODE
6. CATHODE
- STYLE 8:**
PIN 1. DRAIN
2. DRAIN
3. GATE
4. SOURCE3
5. DRAIN
6. DRAIN
- STYLE 9:**
PIN 1. SOURCE 1
2. GATE 1
3. DRAIN 2
4. SOURCE 2
5. GATE 2
6. DRAIN 1
- STYLE 10:**
PIN 1. CATHODE 1
2. N/C
3. CATHODE 2
4. ANODE 2
5. N/C
6. ANODE 1

DOCUMENT NUMBER:	98AON26456D	Electronic versions are uncontrolled except when accessed directly from the Document Repository. Printed versions are uncontrolled except when stamped "CONTROLLED COPY" in red.
DESCRIPTION:	SOT-963, 1X1, 0.35P	PAGE 1 OF 1

ON Semiconductor and are trademarks of Semiconductor Components Industries, LLC dba ON Semiconductor or its subsidiaries in the United States and/or other countries. ON Semiconductor reserves the right to make changes without further notice to any products herein. ON Semiconductor makes no warranty, representation or guarantee regarding the suitability of its products for any particular purpose, nor does ON Semiconductor assume any liability arising out of the application or use of any product or circuit, and specifically disclaims any and all liability, including without limitation special, consequential or incidental damages. ON Semiconductor does not convey any license under its patent rights nor the rights of others.

ON Semiconductor and  are trademarks of Semiconductor Components Industries, LLC dba ON Semiconductor or its subsidiaries in the United States and/or other countries. ON Semiconductor owns the rights to a number of patents, trademarks, copyrights, trade secrets, and other intellectual property. A listing of ON Semiconductor's product/patent coverage may be accessed at www.onsemi.com/site/pdf/Patent-Marking.pdf. ON Semiconductor reserves the right to make changes without further notice to any products herein. ON Semiconductor makes no warranty, representation or guarantee regarding the suitability of its products for any particular purpose, nor does ON Semiconductor assume any liability arising out of the application or use of any product or circuit, and specifically disclaims any and all liability, including without limitation special, consequential or incidental damages. Buyer is responsible for its products and applications using ON Semiconductor products, including compliance with all laws, regulations and safety requirements or standards, regardless of any support or applications information provided by ON Semiconductor. "Typical" parameters which may be provided in ON Semiconductor data sheets and/or specifications can and do vary in different applications and actual performance may vary over time. All operating parameters, including "Typicals" must be validated for each customer application by customer's technical experts. ON Semiconductor does not convey any license under its patent rights nor the rights of others. ON Semiconductor products are not designed, intended, or authorized for use as a critical component in life support systems or any FDA Class 3 medical devices or medical devices with a same or similar classification in a foreign jurisdiction or any devices intended for implantation in the human body. Should Buyer purchase or use ON Semiconductor products for any such unintended or unauthorized application, Buyer shall indemnify and hold ON Semiconductor and its officers, employees, subsidiaries, affiliates, and distributors harmless against all claims, costs, damages, and expenses, and reasonable attorney fees arising out of, directly or indirectly, any claim of personal injury or death associated with such unintended or unauthorized use, even if such claim alleges that ON Semiconductor was negligent regarding the design or manufacture of the part. ON Semiconductor is an Equal Opportunity/Affirmative Action Employer. This literature is subject to all applicable copyright laws and is not for resale in any manner.

PUBLICATION ORDERING INFORMATION

LITERATURE FULFILLMENT:

Email Requests to: orderlit@onsemi.com

ON Semiconductor Website: www.onsemi.com

TECHNICAL SUPPORT

North American Technical Support:
Voice Mail: 1 800-282-9855 Toll Free USA/Canada
Phone: 011 421 33 790 2910

Europe, Middle East and Africa Technical Support:

Phone: 00421 33 790 2910

For additional information, please contact your local Sales Representative