

ACPDQC3V3T-HF

High-Reliability and High-Performance

RoHS Device

Halogen Free



Features

- Bi-directional ESD protection.
- IEC 61000-4-2 ±30kV(Contact).
- ESD Rating of Class 3 per Human Body Model.
- ESD Rating of Class 4 per Machine Model.
- Surface mount package.
- Ultra small SMD package:0402
- High component density.
- AEC-Q101 Qualified.

Mechanical data

- Case: 0402C/SOD-923 Standard package, molded plastic.
- Terminals: Gold plated, solderable per MIL-STD-750, method 2026.
- Mounting position: Any.
- Weight: 0.001 grams (approx.).

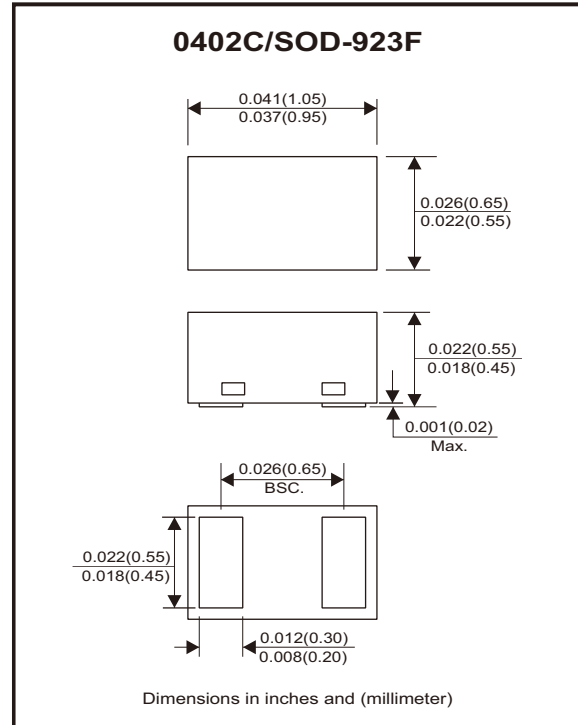

Circuit Diagram



Maximum Rating (at TA=25°C unless otherwise noted)

Parameter	Conditions	Symbol	Value	Unit
Peak pulse power	$T_P = 8/20\mu s$	P_{PP}	180	W
Peak pulse current	$T_P = 8/20\mu s$	I_{PP}	17	A
ESD capability	IEC 61000-4-2(air)	ESD	±30	kV
	IEC 61000-4-2(contact)	ESD	±30	
Operating temperature range		T_j	-40~+125	°C
Storage temperature range		T_{STG}	-55~+150	°C

Electrical Characteristics (at TA=25°C unless otherwise noted)

Parameter	Conditions	Symbol	Min	Typ	Max	Unit
Working peak reverse voltage		V_{RWM}			3.3	V
Breakdown voltage	$I_r = 1mA$	V_{BR}	3.6	4.1	4.6	V
Reverse leakage current	$V_{RWM} = 3.3V$	I_R		<0.02	0.5	μA
Clamping voltage	$I_{PP} = 1A, T_P = 8/20\mu s$	V_C		4.2	4.7	V
	$I_{PP} = 17A, T_P = 8/20\mu s$			8.6	10.6	
Clamping voltage	$I_{PP} = 8A, T_P = 100ns$	V_{CL}		5		V
	$I_{PP} = 16A, T_P = 100ns$			6.2		
Dynamic resistance		R_{DYN}		0.15		Ω
Junction capacitance	$V_R = 0V, f = 1MHz$	C_J		20	25	pF

RATING AND CHARACTERISTIC CURVES (ACPDQC3V3T-HF)

Fig.1 - 8/20 μ s Peak Pulse Current Waveform ACC. IEC 61000-4-5

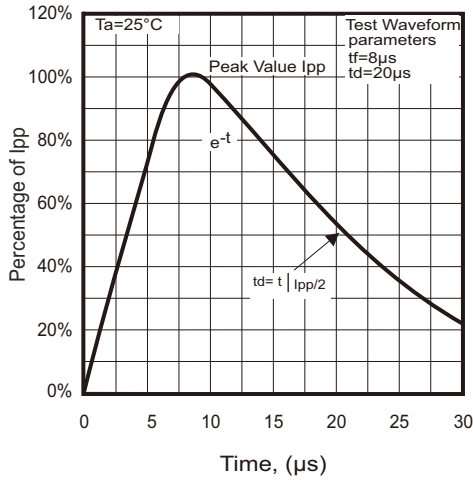

Fig.2 - Capacitance Between Terminals Characteristics

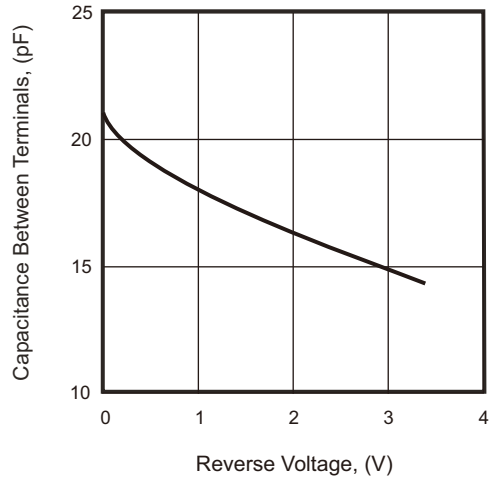

Fig.3 - Clamping Voltage Vs. Peak Pulse Current

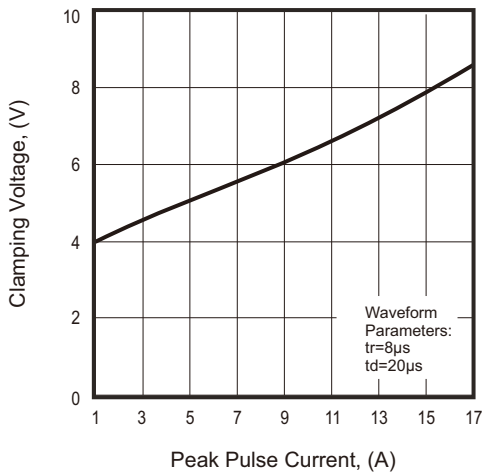

Fig.4 - Power Rating Derating Curve

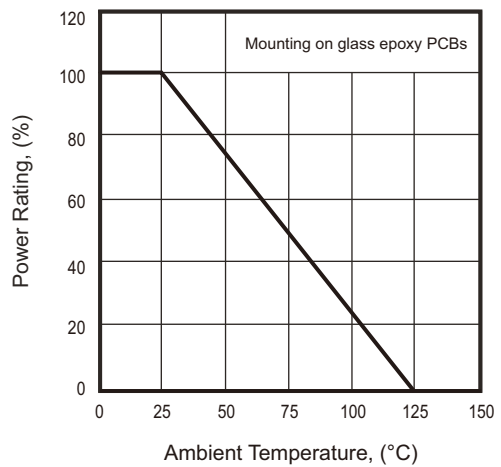
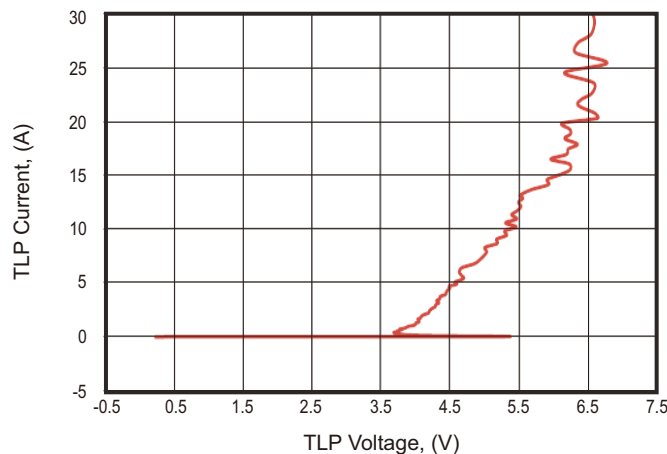
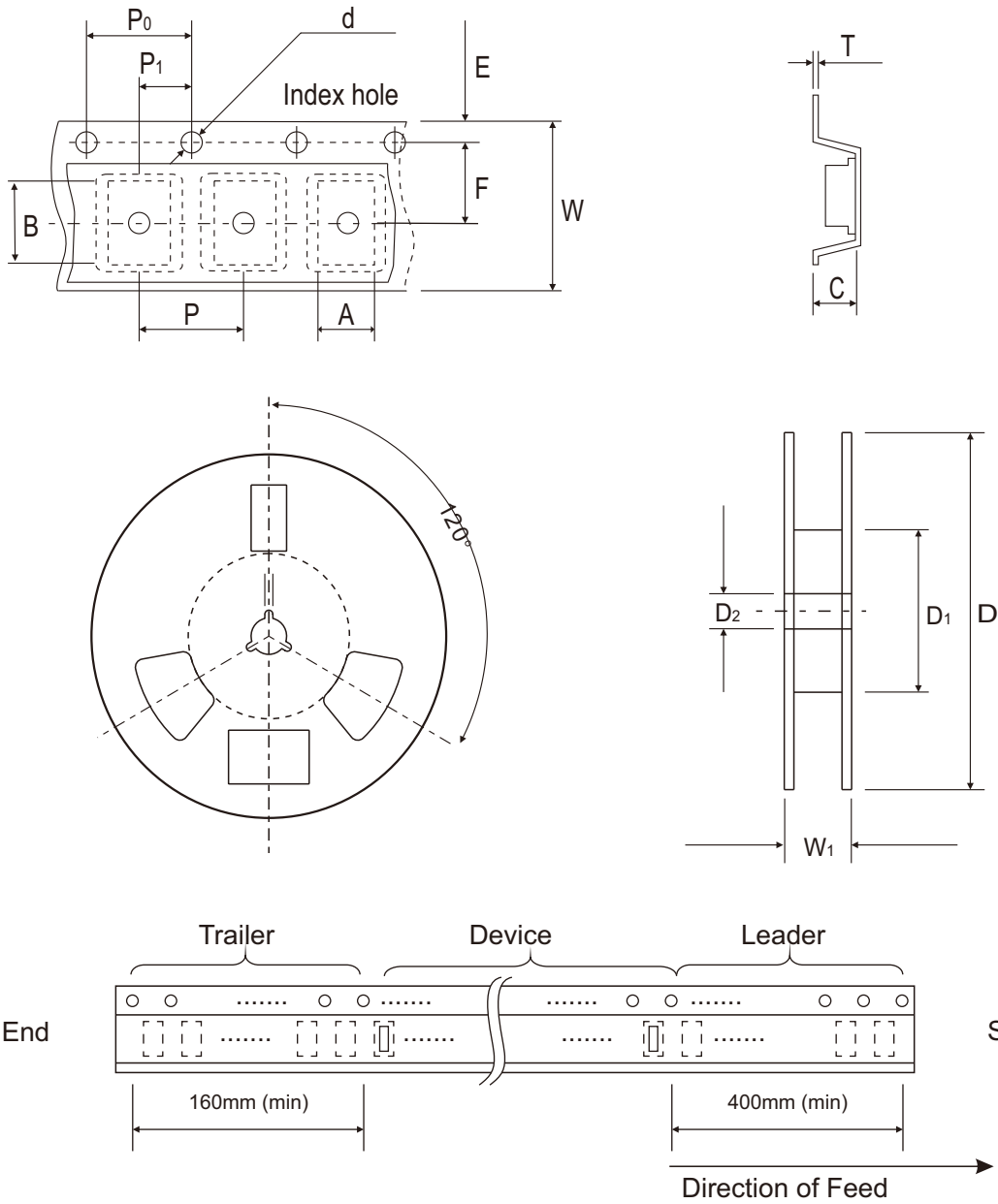

Fig. 5 - Positive TLP IV Curve



Reel Taping Specification



0402C (SOD-923F)	SYMBOL	A	B	C	d	D	D ₁	D ₂
	(mm)	0.75 ± 0.05	1.17 ± 0.05	0.65 ± 0.05	1.50 + 0.10 - 0	178.00 ± 1.00	60.00 ± 0.50	13.50 ± 0.20
	(inch)	0.030 ± 0.002	0.046 ± 0.002	0.026 ± 0.002	0.059 + 0.004 - 0	7.008 ± 0.039	2.362 ± 0.020	0.531 ± 0.008

0402C (SOD-923F)	SYMBOL	E	F	P	P ₀	P ₁	T	W	W ₁
	(mm)	1.75 ± 0.10	3.50 ± 0.10	4.00 ± 0.10	4.00 ± 0.10	2.00 ± 0.10	0.20 + 0.02 - 0.05	8.00 ± 0.20	12.00 + 0.50 - 0
	(inch)	0.069 ± 0.004	0.138 ± 0.004	0.157 ± 0.004	0.157 ± 0.004	0.079 ± 0.004	0.008 + 0.001 - 0.002	0.315 ± 0.008	0.472 + 0.020 - 0

Company reserves the right to improve product design, functions and reliability without notice.

REV:C

Marking Code

Part Number	Marking Code
ACPDQC3V3T-HF	E3



Suggested PAD Layout

SIZE	0402C/SOD-923F	
	(mm)	(inch)
A	0.70	0.028
B	0.40	0.016
C	0.60	0.024
D	1.10	0.043
E	0.30	0.012

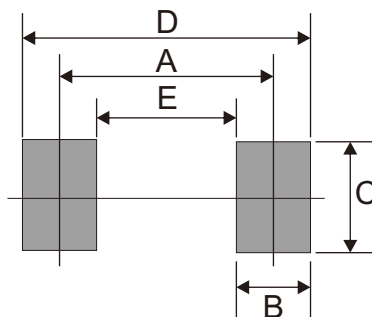

Standard Packaging

Case Type	REEL PACK	
	REEL (pcs)	Reel Size (inch)
0402C/SOD-923F	5,000	7