

REV.	DESCRIPTION	DRAWN	DATE
1	INITIAL RELEASE	TIM	2018/08/01
2	Add Packaging Notes	Fros	2019/04/29
3	ECR1900010, 1000pcs/reel	Fros	2019/06/24

**SPECIFICATION:**

1. ELECTRICAL
  - 1.1 Current Rating:  
Signal (Pin1,2,3,4,5): 1.0A  
Power (Pin1,5): 1.8A ,Other: 0.5A
  - 1.2 Voltage Rating: 250V max
  - 1.3 Contact Resistance: 40mΩ max
  - 1.4 Insulation Resistance: 1000MΩ
  - 1.5 Dielectric Withstanding Voltage: 100VAC
2. MECHANICAL
  - 2.1 Durability: 10,000 Cycle
  - 2.2 Insertion Force: 35N max.
  - 2.3 Extraction Force: 8~20N max.
3. ENVIRONMENTAL
  - 3.1 Operating temperature range: -25°C~+85°C
  - 3.2 Storage temperature range: -20°C~+85°C
  - 3.3 Wasterproof Level: IPX7
4. SOLDER ABILITY
  - 4.1 Recommended IR Reflow Temperature: 260°C +0/-5°C

5	O-RING	Silicon
4	HOLDDOWN	Brass C2680, Matte Tin plating
3	SHELL	Stainless steel SUS301, Matte Tin plating
2	CONTACT	Phosphor Bronze C5191, Contact area: 10u" gold, Solder tail: gold flash
1	HOUSING	LCP, UL94V-0, Black
NO.	PART NAME	DESCRIPTION

UNLESS OTHERWISE SPECIFIED TOLERANCE				 WWW.ATTEND.COM.TW	
UNIT:	DECIMAL	LINEAR	ANGLES		
mm	X.	±0.50	±5°		
	X.X	±0.25	±3°		
	X.XX	±0.12	±1°		
DRAWN	Tim	2018/08/01	DRAWN NAME:		
CHECKED	Fros	2018/08/01	Micro USB B Type Receptacle Waterproof , SMD, 10u" gold ,With post		
APPROVED	Ken	2018/08/01	PRODUCT NO.	207G-BD01	
SCALE	4/1	SHEET	1/3	SIZE	A4
			FILE NAME	207G-BD01_B_3	

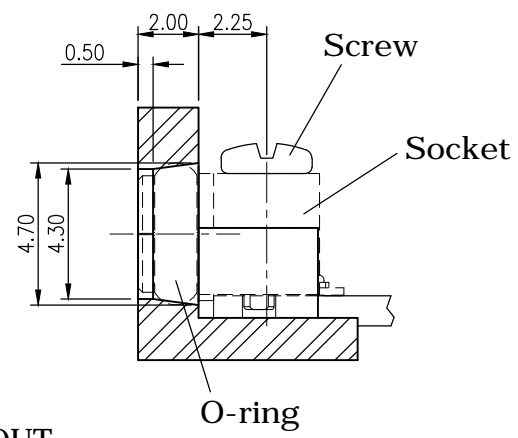
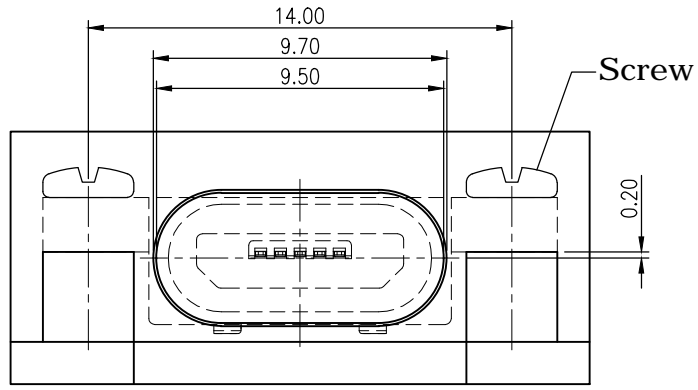

REV.	DESCRIPTION	DRAWN	DATE
	see sheet one		

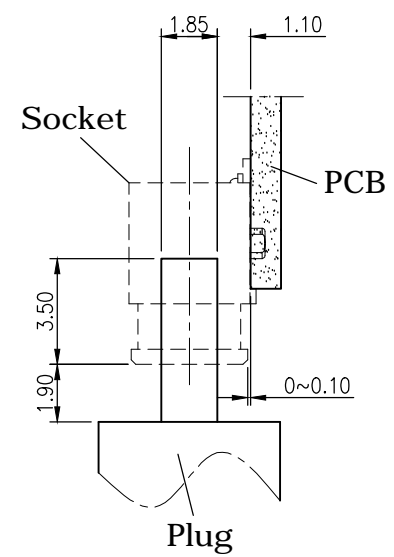
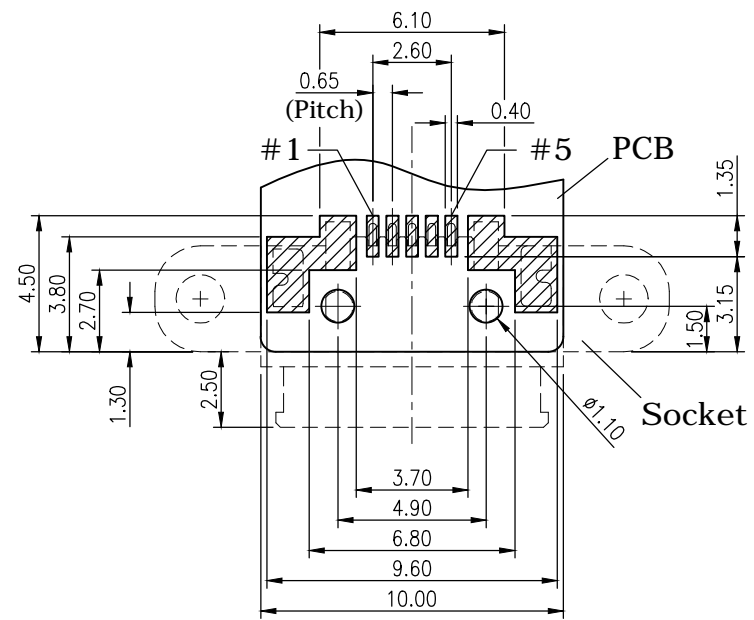

RECOMMEND CUT OUT



RECOMMEND LAYOUT  PAD

UNLESS OTHERWISE SPECIFIED TOLERANCE				 WWW.ATTEND.COM.TW
UNIT:	DECIMAL	LINEAR	ANGLES	
mm	X.	±0.50	±5°	
	X.X	±0.25	±3°	
	X.XX	±0.12	±1°	
DRAWN	Tim	2018/08/01	DRAWN NAME:	
CHECKED	Fros	2018/08/01	Micro USB B Type Receptacle Waterproof , SMD, 10u" gold ,With post	
APPROVED	Ken	2018/08/01	PRODUCT NO.	207G-BD01
	SCALE 4/1	SHEET 2/3	SIZE A4	FILE NAME 207G-BD01_B_3

REV.	DESCRIPTION	DRAWN	DATE
	see sheet one		

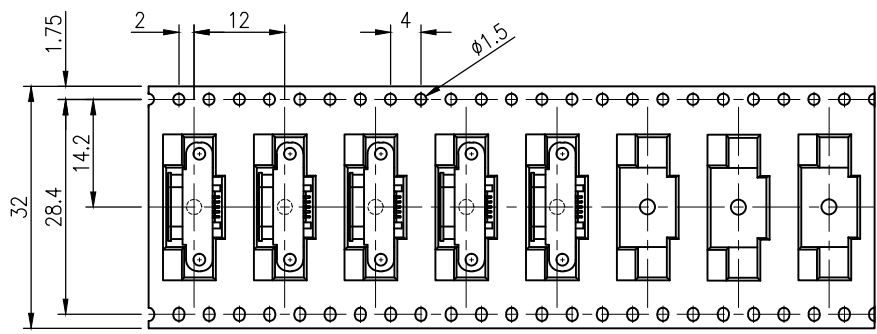
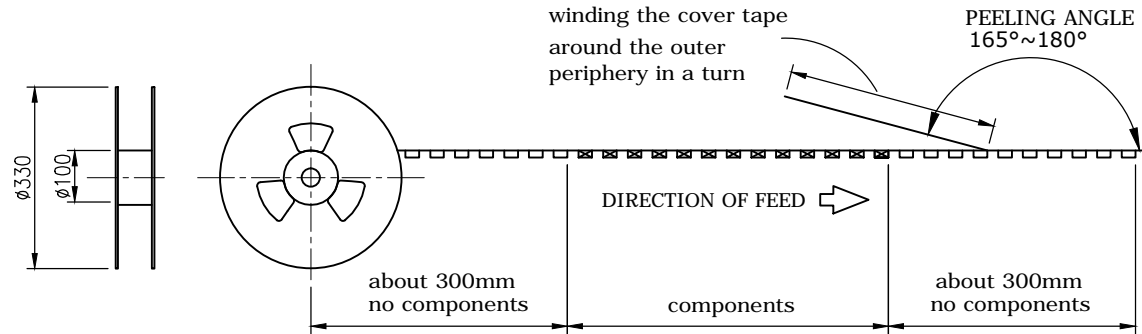

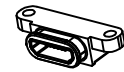



Connector

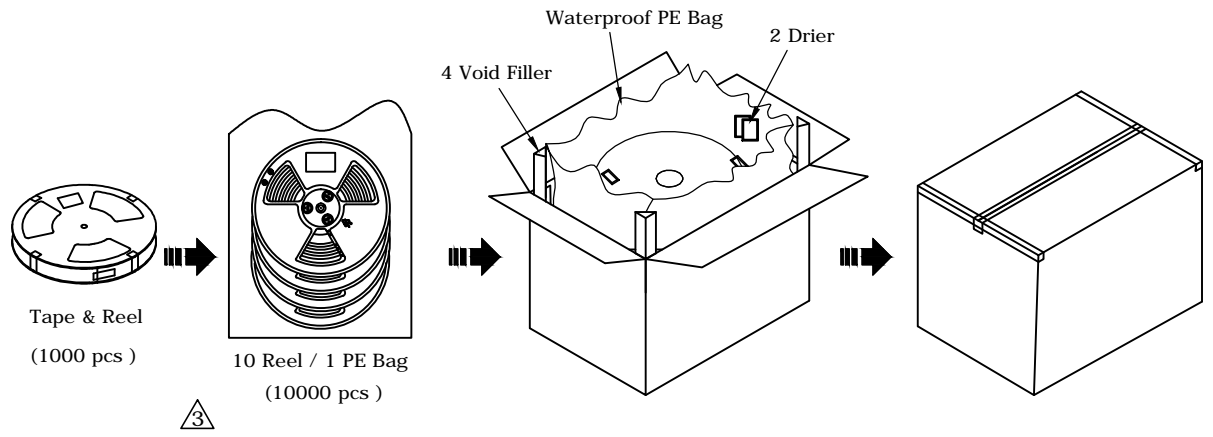
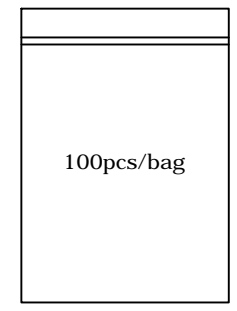

accessory

Connector is packed in reel and O-ring is packed in a zip bag.



UNLESS OTHERWISE SPECIFIED TOLERANCE				
UNIT:	DECIMAL	LINEAR	ANGLES	
mm	X.	±0.50	±5°	
	X.X	±0.25	±3°	
	X.XX	±0.12	±1°	
WWW.ATTEND.COM.TW				
DRAWN	Tim	2018/08/01	DRAWN NAME: Micro USB B Type Receptacle Waterproof , SMD, 10u" gold ,With post	
CHECKED	Fros	2018/08/01		
APPROVED	Ken	2018/08/01		
SCALE		SHEET	SIZE	FILE NAME
N/A		3/3	A4	207G-BD01_B_3