



ARM Cortex[®] -M0

32-BIT MICROCONTROLLER

NuTiny-SDK-NUC122-64P User Manual For NuMicro[™] NUC122 Series

The information described in this document is the exclusive intellectual property of Nuvoton Technology Corporation and shall not be reproduced without permission from Nuvoton.

Nuvoton is providing this document only for reference purposes of NuMicro[™] microcontroller based system design. Nuvoton assumes no responsibility for errors or omissions.

All data and specifications are subject to change without notice.

For additional information or questions, please contact: Nuvoton Technology Corporation.



1	Overview	3
2	NuTiny-SDK-NUC122-64P Introduction	3
2.1	NuTiny-SDK-NUC122-64P Jumper Description	4
2.2	Pin Assignment for Extended Connector	5
2.3	NuTiny-SDK-NUC122-64P PCB Placement.....	6
3	How to Start NuTiny-SDK-NUC122-64P on the Keil μ Vision [®] IDE	7
3.1	Keil μ Vision [®] IDE Software Download and Install	7
3.2	Nuvoton Nu-Link Driver Download and Install	7
3.3	Hardware Setup	7
3.4	Smpl_NuTiny-NUC122 Example Program	8
4	How to Start NuTiny-SDK-NUC122-64P on the IAR Embedded Workbench	9
4.1	IAR Embedded Workbench Software Download and Install.....	9
4.2	Nuvoton Nu-Link Driver Download and Install	9
4.3	Hardware Setup	9
4.4	Smpl_NuTiny-NUC122 Example Program	10
5	NuTiny-EVB-122 Schematic	11
6	Download NuMicro [™] Family Related Files from Nuvoton Website	11
6.1	Download NuMicro [™] Keil μ Vision [®] IDE Driver.....	11
6.2	Download NuMicro [™] IAR EWARM Driver.....	14
6.3	Download NuMicro [™] NUC100 Series BSP Software Library.....	16
7	Revision History.....	17

1 Overview

NuTiny-SDK-NUC122-64P is the specific development tool for NuMicro™ NUC122 series. Users can use NuTiny-SDK-NUC122-64P to develop and verify the application program easily. NuTiny-SDK-NUC122-64P includes two portions. One is NuTiny-EVB-122 and the other is Nu-Link-Me. NuTiny-EVB-122 is the evaluation board and Nu-Link-Me is its Debug Adaptor. Thus, users do not need other additional ICE or debug equipments.

2 NuTiny-SDK-NUC122-64P Introduction

NuTiny-SDK-NUC122-64P uses the NUC122RD2AN as the target microcontroller. Figure 2-1 is NuTiny-SDK-NUC122-64P for NUC122 series, the left portion is called NuTiny-EVB-122 and the right portion is Debug Adaptor called Nu-Link-Me. NuTiny-EVB-122 is similar to other development boards. Users can use it to develop and verify applications to emulate the real behavior. The on board chip covers NUC122 series features. The NuTiny-EVB-122 can be a real system controller to design users' target systems.

Nu-Link-Me is a Debug Adaptor. The Nu-Link-Me Debug Adaptor connects your PC's USB port to your target system (via Serial Wired Debug Port) and allows you to program and debug embedded programs on the target hardware. To use Nu-Link-Me Debug adaptor with IAR or Keil, please refer to "Nuvoton NuMicro™ IAR ICE driver user manual" or "Nuvoton NuMicro™ Keil ICE driver user manual" for detail. These two documents will be stored in the local hard disk when the user installs each driver.

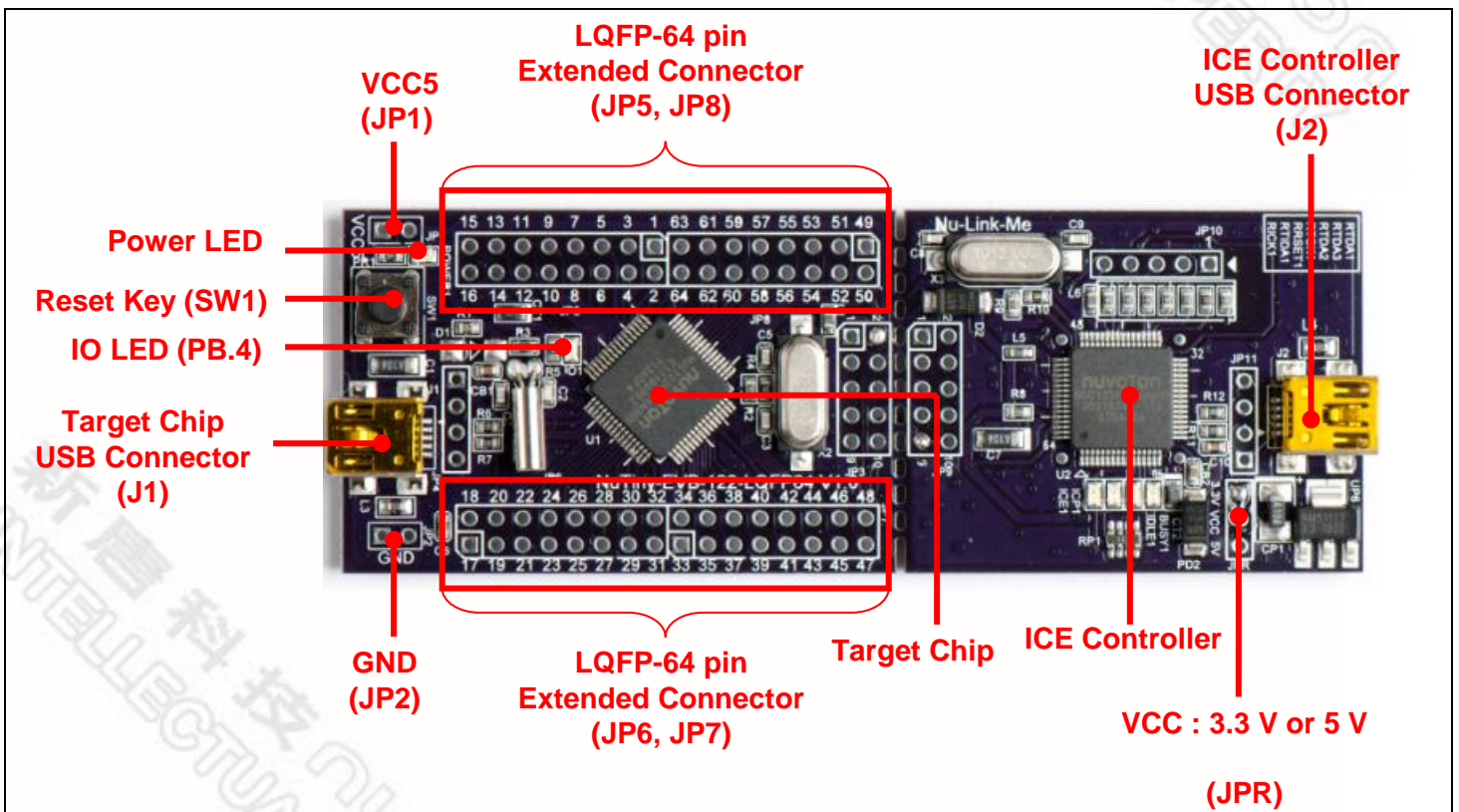

Figure 2-1 NuTiny-SDK-NUC122-64P (Purple PCB Board)

2.1 NuTiny-SDK-NUC122-64P Jumper Description

2.1.1 Power Setting

- J1: USB port in NuTiny-EVB-122
- JP1: VCC5 Voltage connector in NuTiny-EVB-122
- J2: USB port in Nu-Link-Me

POWER Model	J2 USB Port	J1 USB Port	JP1 VCC5	Target MCU Voltage
Model 1	Connect to PC	X	DC 3.3 V or 5 V output ^[1]	DC 3.3 V or 5 V ^[1]
Model 2	X	Connect to PC	DC 4.8 V or 5 V output ^[2]	DC 4.8 V or 5 V ^[2]
Model 3	X	X	DC 2.5 V ~ 5.5 V input	DC 2.5 V ~ 5.5 V that decided by JP1 VCC5 input

X: Unused.

Note 1: It is depended on the setting (VCC via connect to 3.3 V or 5 V via) at JPR jumper in Nu-Link-Me.

Note 2: It must put a diode device (4.8 V) or make the both pins short (5 V) at the D1 in NuTiny-EVB-122.

2.1.2 Debug Connector

- JP3: Connector in target board (NuTiny-EVB-122) for connecting with Nuvoton ICE adaptor (Nu-Link or Nu-Link-Me)
- JP9: Connector in ICE adaptor (Nu-Link-Me) for connecting with a target board (for example NuTiny-EVB-122)

2.1.3 USB Connector

- J1: Mini USB Connector in NuTiny-EVB-122 for application using
- J2: Mini USB Connector in Nu-Link-Me connected to a PC USB port

2.1.4 Extended Connector

- JP5, JP6, JP7 and JP8: Connect to all chip pins in NuTiny-EVB-122

2.1.5 Reset Button

- SW1: Reset button to reset the target chip in NuTiny-EVB-122

2.1.6 Power Connector

- JP1: VCC5 connector in NuTiny-EVB-122
- JP2: GND connector in NuTiny-EVB-122

2.2 Pin Assignment for Extended Connector

NuTiny-EVB-122 provides NUC122RD2AN on board and the extended connector for LQFP-64 pin. Table 2-1 is the pin assignment for NUC122RD2AN.

Pin No	Pin Name	Pin No	Pin Name
01	PB.14, /INT0	33	VSS
02	X32O	34	PC.13
03	X32I	35	PC.12
04	PA.11, I2C1SCL	36	PC.11, MOSI10
05	PA.10, I2C1SDA	37	PC.10, MISO10
06	PD.8	38	VDD
07	PD.9	39	PC.9, SPICLK1
08	PD.10	40	PC.8, SPISS10
09	PD.11	41	PA.15, PWM3
10	PB.4, RX1	42	VSS
11	PB.5, TX1	43	PA.14, PWM2
12	PB.6, RTS1	44	PA.13, PWM1
13	PB.7, CTS1	45	PA.12, PWM0
14	LDO	46	ICE_DAT
15	VDD	47	ICE_CK
16	VSS	48	AVDD
17	VBUS	49	PD.0
18	VDD33	50	PD.1
19	D-	51	PD.2
20	D+	52	PD.3
21	PB.0, RX0	53	PD.4
22	PB.1, TX0	54	PD.5
23	PB.2, RTS0	55	PB.15, /INT1
24	PB.3, CTS0	56	XT1_OUT
25	PC.5	57	XT1_IN
26	PC.4	58	/RESET
27	PC.3, MOSI00	59	VSS
28	PC.2, MISO00	60	VDD
29	PC.1, SPICLK0	61	PS2DAT
30	PC.0, SPISS00	62	PS2CLK
31	PB.10, TM2, SPISS01	63	PVSS
32	PB.9, TM1, SPISS11	64	PB.8, TM0

Table 2-1 Pin Assignment for NUC122 LQFP-64

2.3 NuTiny-SDK-NUC122-64P PCB Placement

Users can refer to Figure 2-2 for the NuTiny-SDK-NUC122-64P PCB placements.

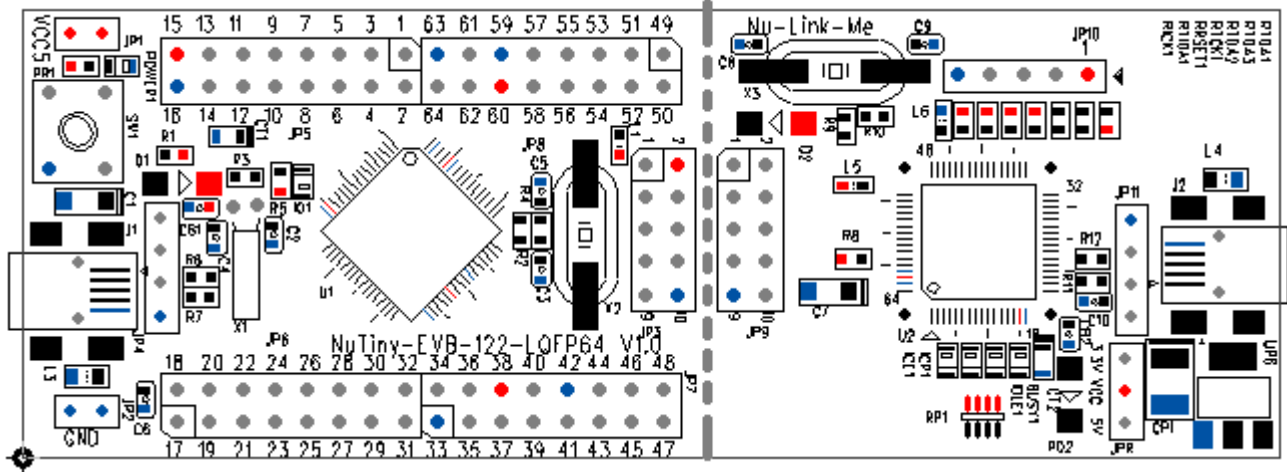

Figure 2-2 NuTiny-SDK-NUC122-64P PCB Placement

新唐科技 NUVOTON
INTELLECTUAL PROPERTY

3 How to Start NuTiny-SDK-NUC122-64P on the Keil μ Vision[®] IDE

3.1 Keil μ Vision[®] IDE Software Download and Install

Please visit the Keil company website (<http://www.keil.com>) to download the Keil μ Vision[®] IDE and install the RVMDK.

3.2 Nuvoton Nu-Link Driver Download and Install

Please visit the Nuvoton company NuMicro[™] website (<http://www.nuvoton.com/NuMicro>) to download “NuMicro[™] Keil μ Vision[®] IDE driver” file. Please refer to Chapter 6.1 for the detail download flow. When the Nu-Link driver has been well downloaded, please unzip the file and execute the “Nu-Link_Keil_Driver.exe” to install the driver.

3.3 Hardware Setup

The hardware setup is shown as Figure 3-1



Figure 3-1 NuTiny-SDK-NUC122-64P Hardware Setup

3.4 Smp1_NuTiny-NUC122 Example Program

This example demonstrates the ease of downloading and debugging an application on a NuTiny-SDK-NUC122-64P board. It can be found on Figure 3-2 list directory and downloaded from Nuvoton NuMicro™ website following on Chapter 6.3.

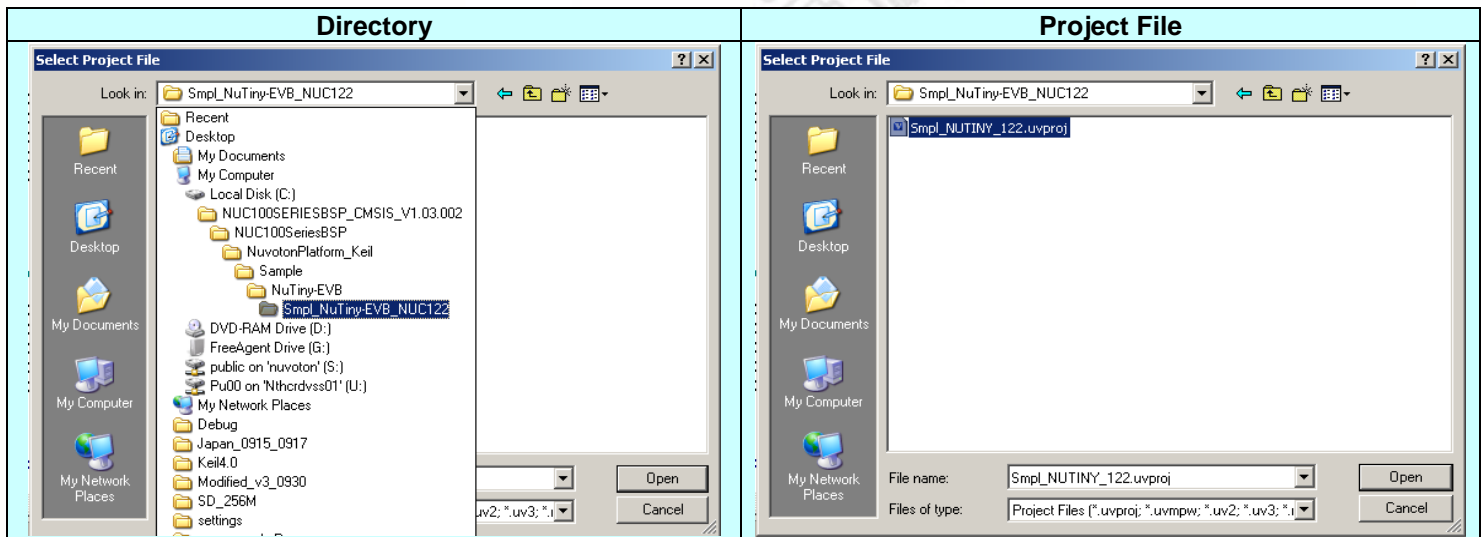









Figure 3-2 Smp1_NuTiny_122 Example Directory

To use this example:

The PB.4 LED will toggle on the NuTiny-EVB-122 board.

-  **Start µVision®**
- **Project-Open**
Open the Smp1_NuTiny_122.uvproj project file
-  **Project - Build**
Compile and link the Smp1_NuTiny-NUC122 application
-  **Flash – Download**
Program the application code into on-chip Flash ROM

-  **Start debug mode**
Using the debugger commands, you may:
 - ◆  Review variables in the watch window
 - ◆  Single step through code
 - ◆  Reset the device
 - ◆  Run the application

4 How to Start NuTiny-SDK-NUC122-64P on the IAR Embedded Workbench

4.1 IAR Embedded Workbench Software Download and Install

Please connect to IAR company website (<http://www.iar.com>) to download the IAR Embedded Workbench and install the EWARM.

4.2 Nuvoton Nu-Link Driver Download and Install

Please connect to the Nuvoton Company NuMicro™ website (<http://www.nuvoton.com/NuMicro>) to download “NuMicro™ IAR ICE driver user manual” file. Please refer to Chapter 6.2 for the detail download flow. When the Nu-Link driver has been well downloaded, please unzip the file and execute the “Nu-Link_IAR_Driver.exe” to install the driver.

4.3 Hardware Setup

The hardware setup is shown as Figure 4-1



Figure 4-1 NuTiny-SDK-NUC122-64P Hardware Setup

4.4 SmpI_NuTiny-NUC122 Example Program

This example demonstrates the ease of downloading and debugging an application on a NuTiny-SDK-NUC122-64P board. It can be found on Figure 4-2 list directory and downloaded from Nuvoton NuMicro™ website following on Chapter 6.3.

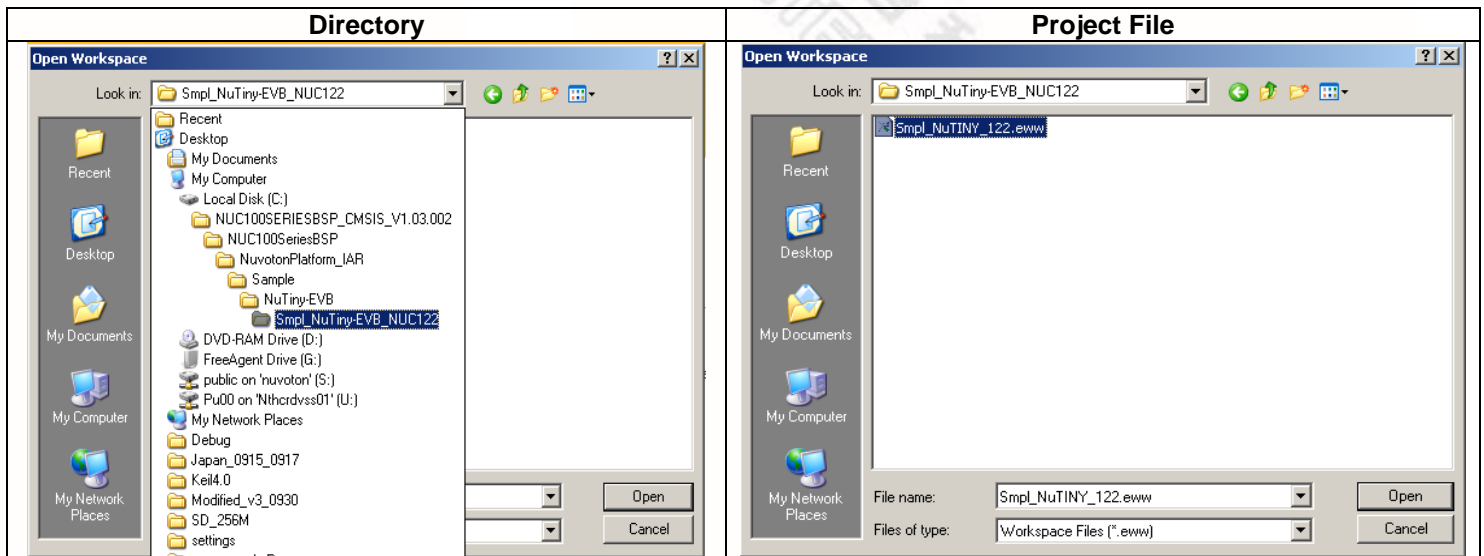







Figure 4-2 SmpI_NuTiny-NUC122 Example Directory

To use this example:

The PB.4 LED will toggle on the NuTiny-EVB-122 board.

-  **Start IAR Embedded Workbench**
- **File-Open-Workspace**
Open the SmpI_NuTiny_122.eww workspace file
-  **Project - Make**
Compile and link the SmpI_NuTiny-122 application

-  **Project – Download and Debug**
Program the application code into on-chip Flash ROM.
 - ◆  Single step through code
 - ◆  Reset the device
 - ◆  Run the application



5 NuTiny-EVB-122 Schematic

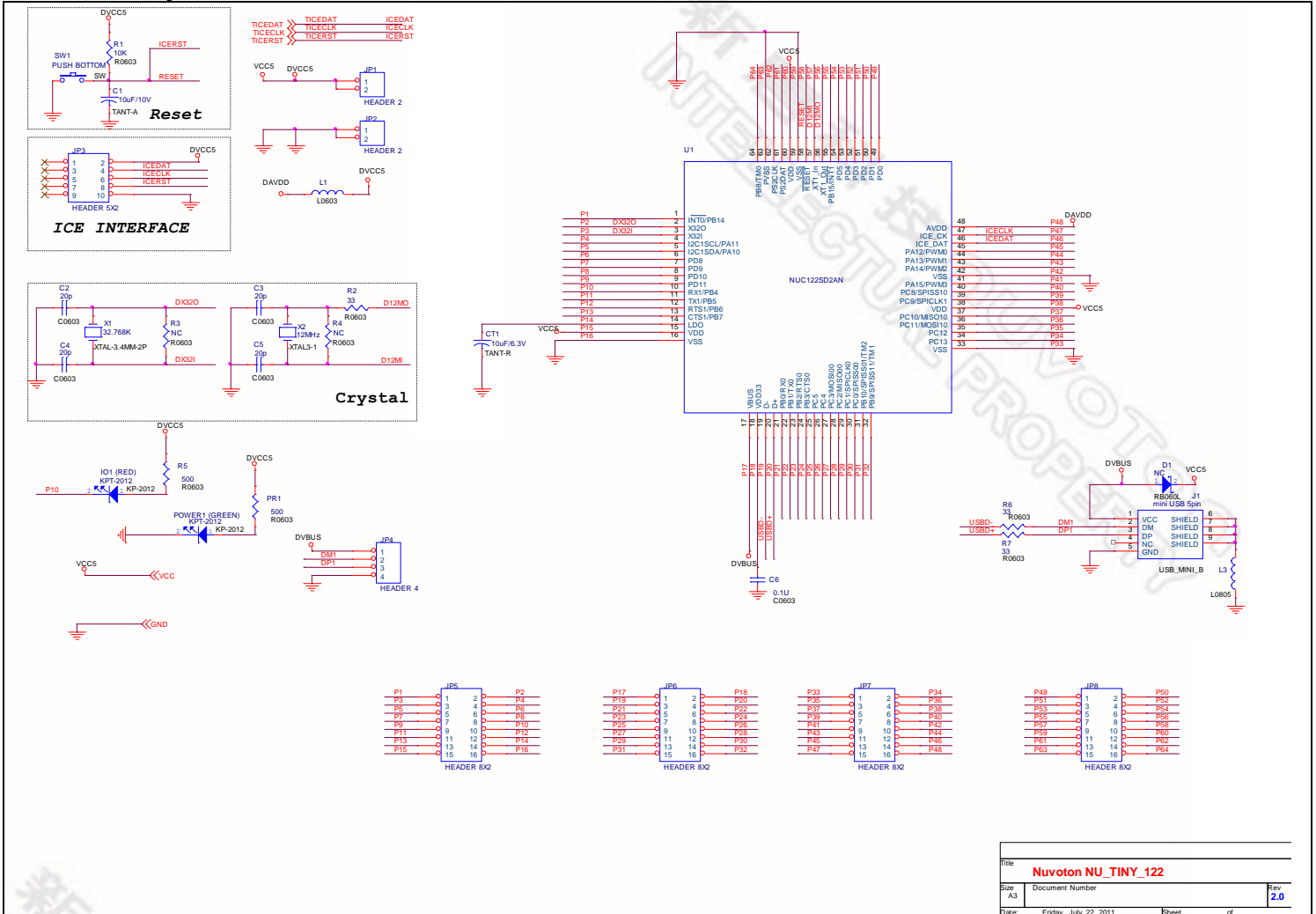

6 Download NuMicro™ Family Related Files from Nuvoton Website

6.1 Download NuMicro™ Keil µVision® IDE Driver

Step1	Visit the Nuvoton NuMicro™ website: http://www.nuvoton.com/NuMicro
--------------	---

Step4	<p>Programmer Software Tools Package</p> <table border="1"> <thead> <tr> <th>File name</th> <th>Description</th> <th>Version</th> <th>Date</th> </tr> </thead> <tbody> <tr> <td> ICP Programming Tool V1.25.6287.zip Revision History </td> <td>NuMicro ICP tool & user manual</td> <td>V1.25.6287</td> <td>2014-01-16</td> </tr> <tr> <td> ISP Programming Tool V1.44.zip Revision History </td> <td>NuMicro ISP Programming Tool & user manual</td> <td>V1.44</td> <td>2014-01-20</td> </tr> <tr> <td> NuGang Programmer V6.21.zip Revision History </td> <td>NuGang Programmer software & user manual</td> <td>V6.21</td> <td>2014-01-24</td> </tr> </tbody> </table> <p>Nu-Link Driver</p> <table border="1"> <thead> <tr> <th>File name</th> <th>Description</th> <th>Version</th> <th>Date</th> </tr> </thead> <tbody> <tr> <td> Nu-Link Driver for KeilRVMDK V1.25.6287.zip Revision History </td> <td>This driver is to support Nu-Link to work under Keil RVMDK Development Environment for all NuMicro Family Devices.</td> <td>V1.25.6287</td> <td>2014-01-16</td> </tr> <tr> <td> Nu-Link Driver for IAR EWARM V1.25.6287.zip Revision History </td> <td>This driver is to support Nu-Link to work under IAR EWARM Development Environment for all NuMicro Family Devices.</td> <td>V1.25.6287</td> <td>2014-01-16</td> </tr> </tbody> </table> <p style="text-align: center;"> </p> <p style="text-align: right;"> User Feedback ↑ TOP </p>	File name	Description	Version	Date	ICP Programming Tool V1.25.6287.zip Revision History	NuMicro ICP tool & user manual	V1.25.6287	2014-01-16	ISP Programming Tool V1.44.zip Revision History	NuMicro ISP Programming Tool & user manual	V1.44	2014-01-20	NuGang Programmer V6.21.zip Revision History	NuGang Programmer software & user manual	V6.21	2014-01-24	File name	Description	Version	Date	Nu-Link Driver for KeilRVMDK V1.25.6287.zip Revision History	This driver is to support Nu-Link to work under Keil RVMDK Development Environment for all NuMicro Family Devices.	V1.25.6287	2014-01-16	Nu-Link Driver for IAR EWARM V1.25.6287.zip Revision History	This driver is to support Nu-Link to work under IAR EWARM Development Environment for all NuMicro Family Devices.	V1.25.6287	2014-01-16
	File name	Description	Version	Date																									
ICP Programming Tool V1.25.6287.zip Revision History	NuMicro ICP tool & user manual	V1.25.6287	2014-01-16																										
ISP Programming Tool V1.44.zip Revision History	NuMicro ISP Programming Tool & user manual	V1.44	2014-01-20																										
NuGang Programmer V6.21.zip Revision History	NuGang Programmer software & user manual	V6.21	2014-01-24																										
File name	Description	Version	Date																										
Nu-Link Driver for KeilRVMDK V1.25.6287.zip Revision History	This driver is to support Nu-Link to work under Keil RVMDK Development Environment for all NuMicro Family Devices.	V1.25.6287	2014-01-16																										
Nu-Link Driver for IAR EWARM V1.25.6287.zip Revision History	This driver is to support Nu-Link to work under IAR EWARM Development Environment for all NuMicro Family Devices.	V1.25.6287	2014-01-16																										
Step5	Download the NuMicro™ Keil μVision® IDE driver.																												

新唐科技 NUVOTON
 INTELLECTUAL PROPERTY

6.2 Download NuMicro™ IAR EWARM Driver

<p>Step1</p>	<p>Visit the Nuvoton NuMicro™ website: http://www.nuvoton.com/NuMicro.</p>
<p>Step2</p>	 <p>The screenshot shows the Nuvoton website navigation menu. The 'Support' menu is open, and 'Tool & Software' is highlighted with a red dashed box. A yellow callout bubble with a red arrow points to this option, containing the text: "Click here to enter Tool & Software."</p>
<p>Step3</p>	 <p>The screenshot shows the 'Development Tool Hardware' page on the Nuvoton website. The left sidebar menu has 'Software' highlighted with a red dashed box. A yellow callout bubble with a red arrow points to this option, containing the text: "Click here to enter Device Driver and Software Library."</p>

Step4	<p>Programmer Software Tools Package</p> <table border="1"> <thead> <tr> <th>File name</th> <th>Description</th> <th>Version</th> <th>Date</th> </tr> </thead> <tbody> <tr> <td> ICP Programming Tool V1.25.6287.zip Revision History </td> <td>NuMicro ICP tool & user manual</td> <td>V1.25.6287</td> <td>2014-01-16</td> </tr> <tr> <td> ISP Programming Tool V1.44.zip Revision History </td> <td>NuMicro ISP Programming Tool & user manual</td> <td>V1.44</td> <td>2014-01-20</td> </tr> <tr> <td> NuGang Programmer V6.21.zip Revision History </td> <td>NuGang Programmer software & user manual</td> <td>V6.21</td> <td>2014-01-24</td> </tr> </tbody> </table>	File name	Description	Version	Date	ICP Programming Tool V1.25.6287.zip Revision History	NuMicro ICP tool & user manual	V1.25.6287	2014-01-16	ISP Programming Tool V1.44.zip Revision History	NuMicro ISP Programming Tool & user manual	V1.44	2014-01-20	NuGang Programmer V6.21.zip Revision History	NuGang Programmer software & user manual	V6.21	2014-01-24
	File name	Description	Version	Date													
ICP Programming Tool V1.25.6287.zip Revision History	NuMicro ICP tool & user manual	V1.25.6287	2014-01-16														
ISP Programming Tool V1.44.zip Revision History	NuMicro ISP Programming Tool & user manual	V1.44	2014-01-20														
NuGang Programmer V6.21.zip Revision History	NuGang Programmer software & user manual	V6.21	2014-01-24														
<p>Nu-Link Driver</p> <table border="1"> <thead> <tr> <th>File name</th> <th>Description</th> <th>Version</th> <th>Date</th> </tr> </thead> <tbody> <tr> <td> Nu-Link Driver for Keil RVMDK V1.25.6287.zip Revision History </td> <td>This driver is to support Nu-Link to work under Keil RVMDK Development Environment for all NuMicro Family Devices.</td> <td>V1.25.6287</td> <td>2014-01-16</td> </tr> <tr> <td> Nu-Link Driver for IAR EWARM V1.25.6287.zip Revision History </td> <td>This driver is to support Nu-Link to work under IAR EWARM Development Environment for all NuMicro Family Devices.</td> <td>V1.25.6287</td> <td>2014-01-16</td> </tr> </tbody> </table> <p style="text-align: center;"> </p> <p style="text-align: right;"> User Feedback ↑ TOP </p>	File name	Description	Version	Date	Nu-Link Driver for Keil RVMDK V1.25.6287.zip Revision History	This driver is to support Nu-Link to work under Keil RVMDK Development Environment for all NuMicro Family Devices.	V1.25.6287	2014-01-16	Nu-Link Driver for IAR EWARM V1.25.6287.zip Revision History	This driver is to support Nu-Link to work under IAR EWARM Development Environment for all NuMicro Family Devices.	V1.25.6287	2014-01-16					
File name	Description	Version	Date														
Nu-Link Driver for Keil RVMDK V1.25.6287.zip Revision History	This driver is to support Nu-Link to work under Keil RVMDK Development Environment for all NuMicro Family Devices.	V1.25.6287	2014-01-16														
Nu-Link Driver for IAR EWARM V1.25.6287.zip Revision History	This driver is to support Nu-Link to work under IAR EWARM Development Environment for all NuMicro Family Devices.	V1.25.6287	2014-01-16														
Step5	Download the NuMicro™ IAR EWARM driver.																

新唐科技 NUVOTON
 INTELLECTUAL PROPERTY

6.3 Download NuMicro™ NUC100 Series BSP Software Library

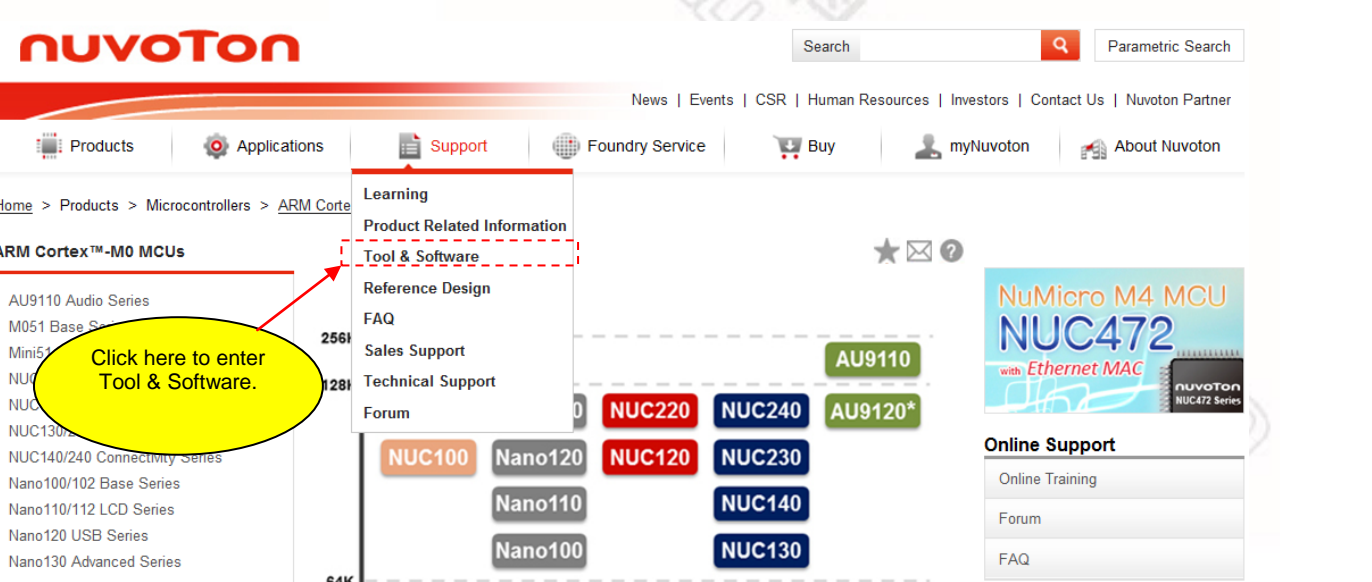
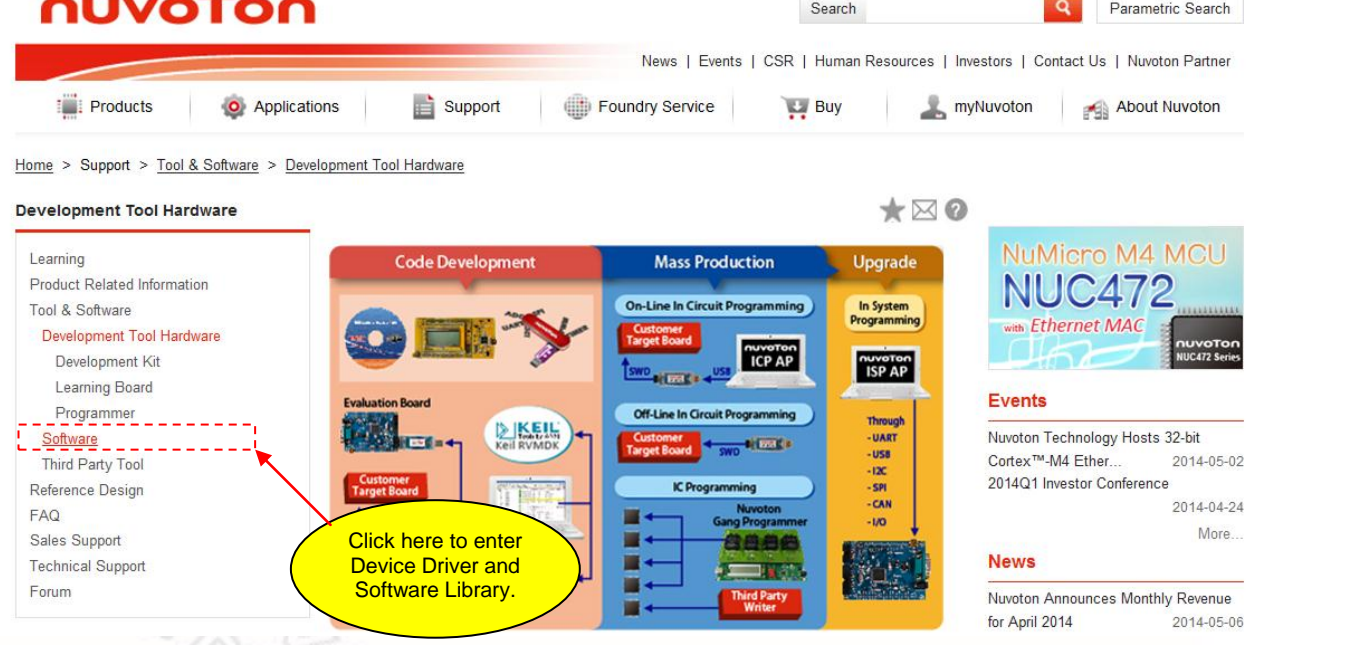
<p>Step1</p>	<p>Visit the Nuvoton NuMicro™ website: http://www.nuvoton.com/NuMicro.</p>
<p>Step2</p>	
<p>Step3</p>	
<p>Step 3</p>	<p>Download the “NUC122 BSP CMSIS”.</p>

7 Revision History

Version	Date	Page	Description
1.0	Mar. 25, 2011	--	Initial Release
1.1	July. 14, 2014	--	Update the resistor value of D+/D- on the target chip NUC122.

Important Notice

Nuvoton products are not designed, intended, authorized or warranted for use as components in systems or equipment intended for surgical implantation, atomic energy control instruments, airplane or spaceship instruments, transportation instruments, traffic signal instruments, combustion control instruments, or for other applications intended to support or sustain life. Further more, Nuvoton products are not intended for applications wherein failure of Nuvoton products could result or lead to a situation wherein personal injury, death or severe property or environmental damage could occur.

Nuvoton customers using or selling these products for use in such applications do so at their own risk and agree to fully indemnify Nuvoton for any damages resulting from such improper use or sales.

Please note that all data and specifications are subject to change without notice. All the trademarks of products and companies mentioned in this datasheet belong to their respective owners.