

---

# 规格承认书

## SPECIFICATION FOR APPROVAL

客 户

CUSTOMER:

---

客户料号

CUST' S PART NO: PSC127MT101#

---

品 名

DESCRIPTION: CDRH127-101M

---

号 码

NO. : 19-936

日 期

DATE: 2020-02-24

---

	“v”	客户签章 CUSTOMER' S SIGNATURE	备 注 NOTE
承 认 FULL APPROVED			
部分承认 CONDITIONAL APPROVED			
驳 回 REJECTED			

拟 制                      审 核                      批 准  
DESIGNED BY: 殷荣忠 EXAMINED BY: 范耀明 APPROVED BY: 范耀明

常州银河创新磁电有限公司  
CHANGZHOU GALAXY INNOVATION MAGNETOELECTRICITYCO., LTD  
技术部  
TECHNICAL DEPT

## 1. Scope:

This specification applies the Shielded construction Assembly Type SMD Power inductor CDRH127-101M

## 2. Outline:

The products are used as choke coils for DC/DC converter and consist of drum core, ring core, coil and terminals.

## 3. Safety Specification:

The products shall be used as secondary circuit parts, thus are not applied by any specific safety standards.

## 4. Specification:

### 4.1. Dimensions

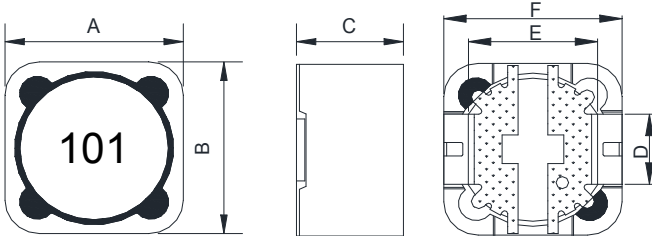

A	12.0±0.5	D	5.0 Typ.
B	12.0±0.5	E	7.6 Typ.
C	8.0 Max.	F	12.0 Typ.

### 4.2. Main parts list

No.	Part name	Material	Quantity
1	Drum Core	Ni-Zn Ferrite or Equivalent	1set
2	Ring Core	Ni-Zn Ferrite or Equivalent	1set
3	Coil	Cu/P180/Grand 1(Grand 2)/Polyurethane enameled Cooper wire or Equivalent	1set
4	Hoop	Cu C5191 or Equivalent External electrode (surface solder coating) Sn-Ag-Cu	1set
5	Solder	Sn99.3: Cu0.7 or Equivalent	0.015 g
6	Glue	Resin	0.020 g
7	Ink	Black	0.0001 g

### 4.3. Pin Connection:

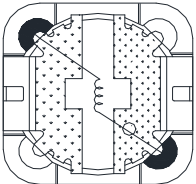

### 4.4. Recommended Land Pattern:

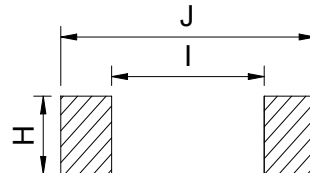

H	5.4 Ref.
I	7.0 Ref.
J	12.8 Ref.

### 4.5. Electrical Specifications:

Part Number	L (1) Rated Inductance (μH)	Test Condition	D.C.R. DC Resistance at 25°C (mΩ)	S.R.F. Self-Resonant Frequency (MHz)	Isat (2) Saturation Current (A)	Irms(3) Heat Rating Current (A)	Part Marking Designator
CDRH127-101M	100±20%	100kHz, 1.0Vrms	220 Max. 170Typ.	4.5 Typ.	2.88 Max. 3.28 Typ.	1.70 Max. 2.20 Typ.	101

(1) Open Circuit Inductance Test Parameters: 100kHz, 1.0Vrms, 0.0Adc.

(2) Isat Amperes Typical for approximately 30% roll off (@25°C)

(3) I rms: current for an approximate ΔT of 40°C without core loss s(Ta=25°C). It is recommended that the temperature of the part not

exceed 125°C. PCB layout, trace thickness and width, air-flow, and proximity of other heat generating components will affect the temperature rise. It is recommended that the temperature of the part not exceed 125°C under worst case operating conditions verified in the end application.

(4) Rated current: Isat and I rms whichever is lower.

Note: The rated current is subject to change depending on the cooling

4.6. Ordering Code & Explanation of Part Numbers:

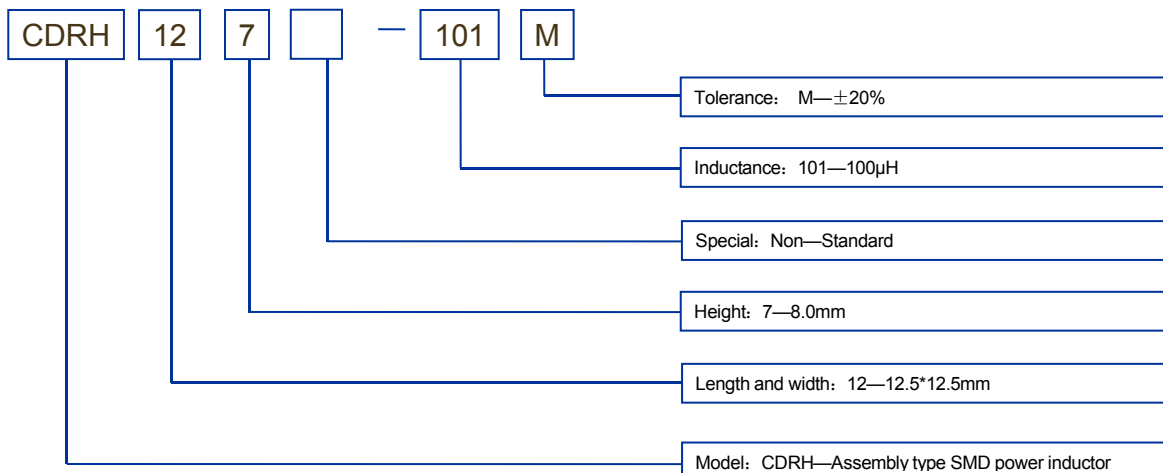

4.7. Bias Characteristic

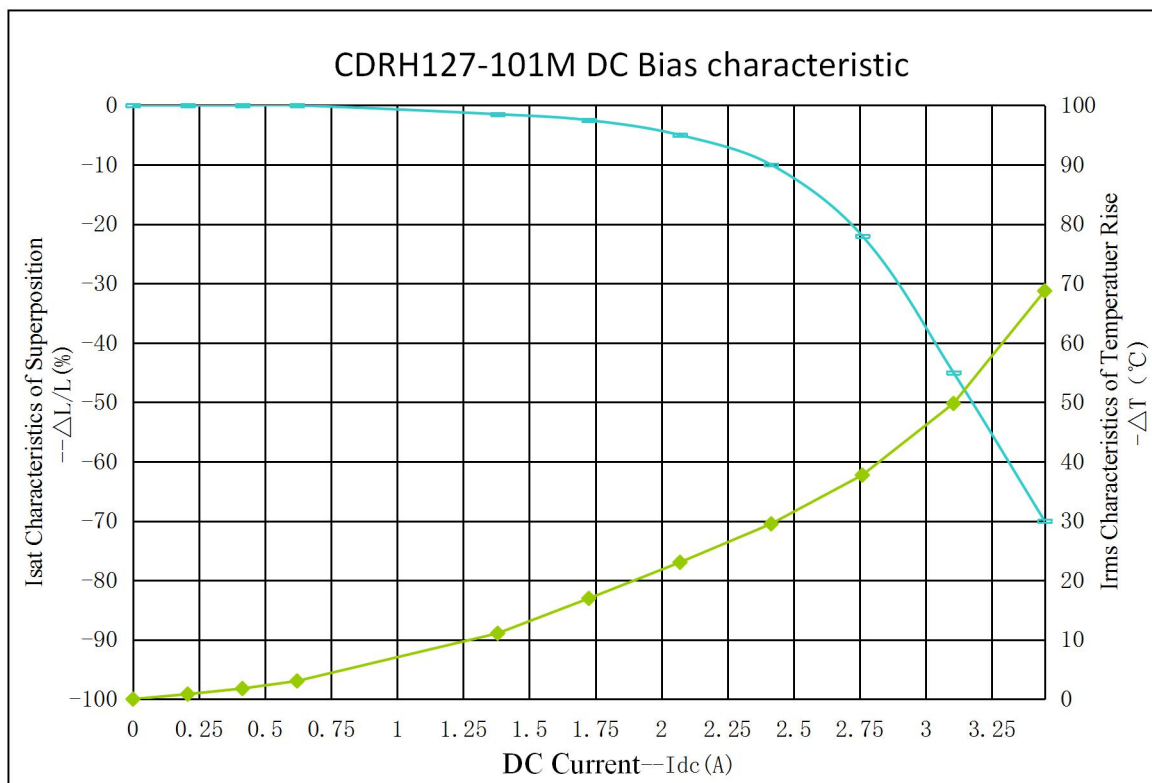

## 5.Package Specification:

### 5.1. Taping Specification:

#### 5.1.1.Reel Dimension (Unit: mm) :

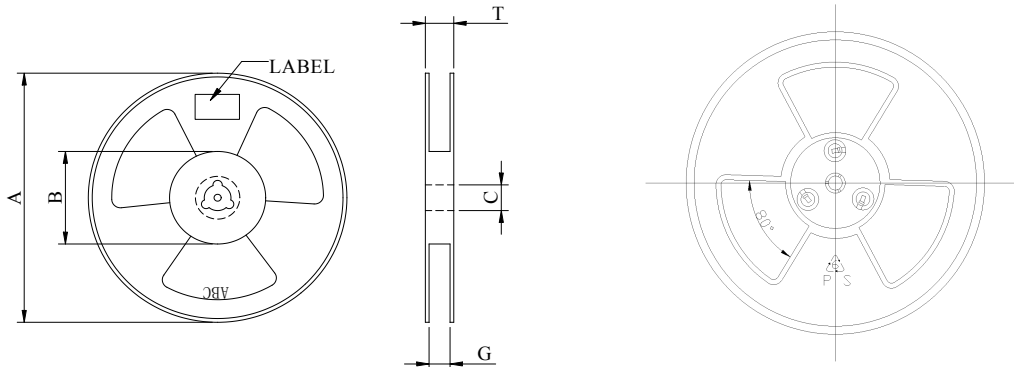

#### 5.1.2. Taping Dimension (Unit: mm) :

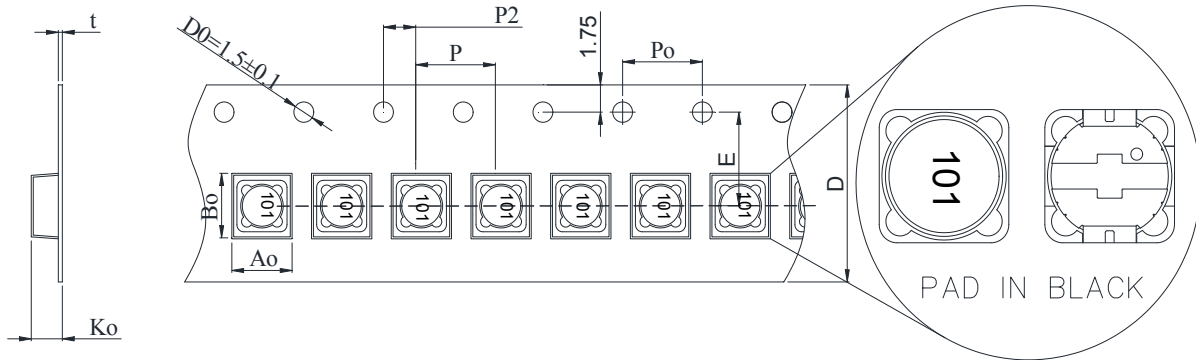

STA YLE	Q'TY (PCS)	A	B	C	D	G	T	E	A0	B0	K0	t	P	Po	P2
13"	500	330	100	13.5 ±0.2	24.0 ±0.5	24.4 ±2.0	29.4 Max	11.5 ±0.1	12.6 ±0.1	12.6 ±0.1	8.2 ±0.1	0.40 ±0.05	16.0 ±0.2	4.0 ±0.2	2.0 ±0.1

#### 5.1.3. Tensile Strength:

5.1.3.1. Plastic tape :  $\cong 10N$  ( $\cong 1.0kgf$ )

5.1.3.2. Material : PS

5.1.3.3. Cover tape :  $\cong 5N$  ( $\cong 0.5kgf$ )

#### 5.1.4. Tensile Strength of Cover Tape (Ref.):

F=0.2~0.9N

Angel of pull 0 ~ 15 ° opposite the forward direction, Velocity of pull: 300 mm/min.

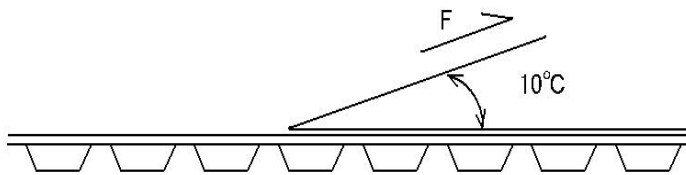

#### 5.1.5.Packing Style of Taping (Unit: mm)

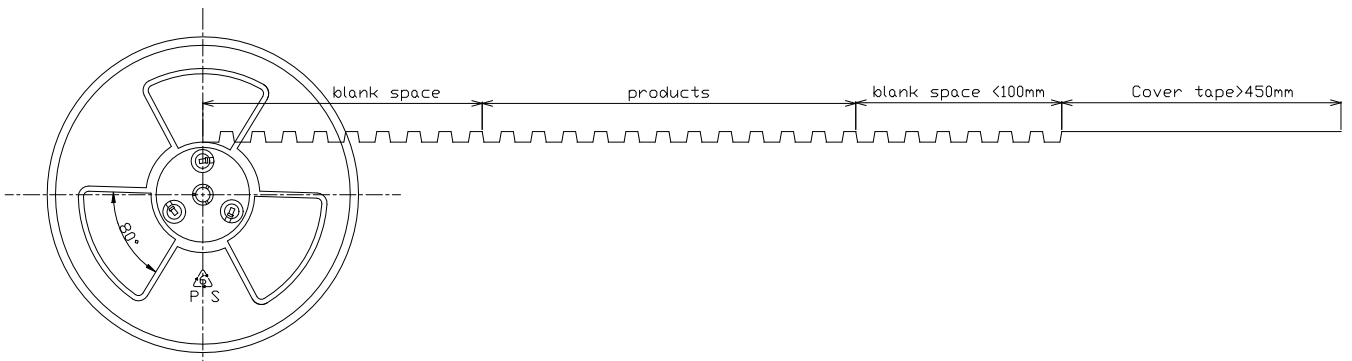

#### 5.1.6. Packaging Style of Products:

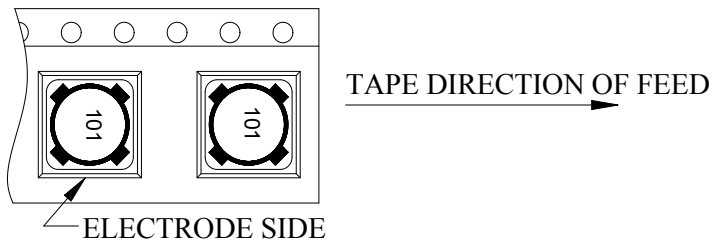

5.1.7. Packaging style of case

5.1.7.1. Packing cases are composed of the inner case and outer case.

5.1.7.2. Three inner cases are put in an outer, thus 3,000 products put in an outer case.

5.1.7.3. Paper cushion are placed on the upper and bottom side in the outer case

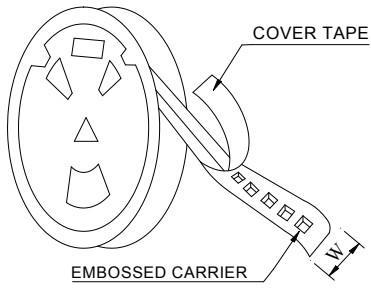

500 pcs in 1 reel (inner) case

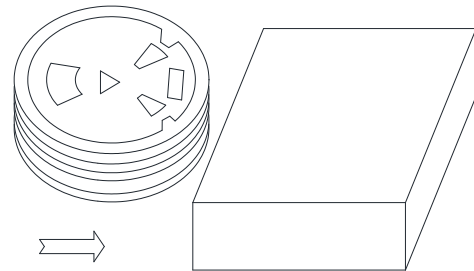

2 reels in 1 reels (inner) cases

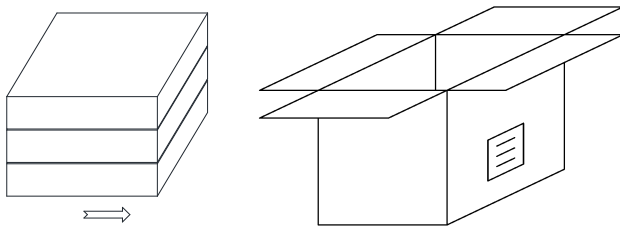

3 reels (inner) cases in 1 packaging (outer) case