

# High Power UV LED Product Specification

Updated on 2018/08/01

Approval Sheet

PU88S01 UV Emitter  
Product Specification

RoHS

<b>Product</b>	UV 3535 Emitter
<b>Part Number</b>	PU88S01
<b>Customer</b>	
<b>Issue Date</b>	2015/6/1



### ■ Feature

- ✓ 3W UV LED Emitter
- ✓ Compact dimensions: 3.45 mm × 3.45 mm × 2.10 mm
- ✓ Dice Technology : AlGaIn
- ✓ View angle:  $\theta = 125^\circ$
- ✓ High power operation
- ✓ Low thermal resistance
- ✓ Environmental friendly ; RoHS compliance

### ■ Applications

- ✓ UV curing
- ✓ Counterfeit banknote detection
- ✓ Photo catalytic purification

MAKER			CUSTOMER			
Prepared	Checked	Approved				
Taichi Wang	Vincent Chuang	KH Shen				

## Outline Dimension

PU88S01 UV Emitter  
Product Specification

### Outline Dimension

Top view

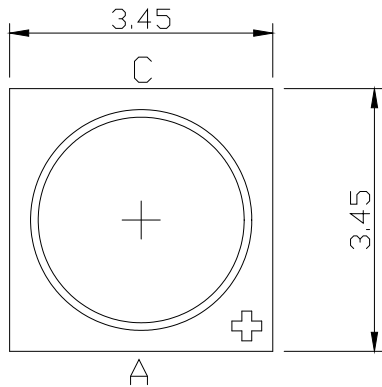

Bottom view

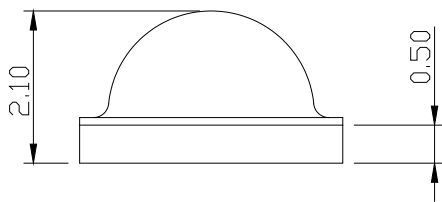
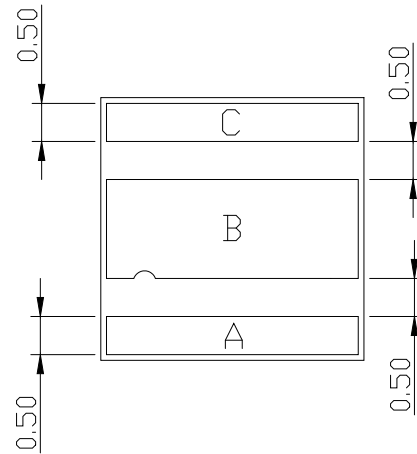

Unit:mm

A:Anode  
B:Thermal  
C:Cathode

Protection Device

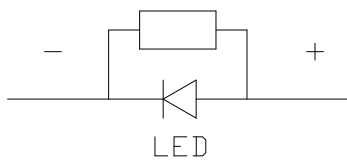

\*. Tolerance:±0.15mm

## Performance

PU88S01 UV Emitter  
 Product Specification

### Opto-Electrical Characteristics

Parameter	Symbol	Condition	Min.	Typ.	Max.	Unit	
Forward Voltage <sup>*(1)</sup>	$V_F$	$I_F = 500\text{mA}$	3.2	3.6	4.2	V	
Wavelength <sup>*(2)</sup>	$W_P$	$I_F = 500\text{mA}$	365	--	410	nm	
Thermal Resistance <sup>*(3)</sup>	$R_{th}$	$I_F = 500\text{mA}$	6	--	10	$^{\circ}\text{C}/\text{W}$	
View Angle	$\theta$	$I_F = 500\text{mA}$	--	125	--	deg	
Reverse Current	$I_R$	$V_R = 5\text{V}$			10	$\mu\text{A}$	
Radiant Power <sup>*(4)</sup>	$P_O$	$I_F = 500\text{mA}$	365nm	--	750	--	mW
			385nm	--	880	--	
			395nm	--	900	--	
			405nm	--	900	--	

(1).The Forward Voltage tolerance is  $\pm 0.1\text{V}$

(2).Peak Wavelength tolerance is  $\pm 3\text{nm}$

(3).Thermal resistance is calculated from junction to solder

(4).The Radiant Power tolerance  $\pm 10\%$

### Absolute Maximum Ratings

Parameter	Symbol	Rating	Unit
DC Forward Current	$I_F$	700	mA
Surge Forward Current <sup>*(1)</sup>	$I_{FS}$	1000	mA
ESD	$V_{ESD}$	8000	V
Power Dissipation	$P_d$	3.10	W
Soldering Temperature <sup>*(2)</sup>	$T_S$	260	$^{\circ}\text{C}$
Junction Temperature	$T_J$	120	$^{\circ}\text{C}$
Storage Temperature	$T_{Stg}$	-40~+100	$^{\circ}\text{C}$
Operation Temperature	$T_{Op}$	-30~+85	$^{\circ}\text{C}$

(1) Frequency Duty $<10\%$ ,  $t_p=100\mu\text{s}$ .

(2) JEDEC STD-020 latest version compliant.

(3) Proper current rating must be observed to maintain junction temperature below  $T_J$  max.

**Binning**

PU88S01 UVA Emitter  
 Product Specification

**Wavelength Rank (Ta=25°C)**

W <sub>P</sub> Rank	Min.	Max.	Unit	Condition
U0365	365	370	nm	I <sub>F</sub> =500mA
U0385	380	390	nm	I <sub>F</sub> =500mA
U0395	390	400	nm	I <sub>F</sub> =500mA
U0405	400	410	nm	I <sub>F</sub> =500mA

**Radiant Power Rank (Ta=25°C)**

P <sub>O</sub> Rank	Min.	Max.	Unit	Condition
01	550	600	mW	I <sub>F</sub> =500mA
02	600	650	mW	I <sub>F</sub> =500mA
03	650	700	mW	I <sub>F</sub> =500mA
04	700	750	mW	I <sub>F</sub> =500mA
05	750	800	mW	I <sub>F</sub> =500mA
06	800	850	mW	I <sub>F</sub> =500mA
07	850	900	mW	I <sub>F</sub> =500mA
08	900	950	mW	I <sub>F</sub> =500mA
09	950	1000	mW	I <sub>F</sub> =500mA
10	1000	1050	mW	I <sub>F</sub> =500mA

**Forward Voltage Rank (Ta=25°C)**

V <sub>F</sub> Rank	Min.	Max.	Unit	Condition
01	3.2	3.4	V	I <sub>F</sub> =500mA
02	3.4	3.6	V	I <sub>F</sub> =500mA
03	3.6	3.8	V	I <sub>F</sub> =500mA
04	3.8	4.0	V	I <sub>F</sub> =500mA
05	4.0	4.2	V	I <sub>F</sub> =500mA

**Bin code definition (for example)**

W <sub>P</sub> Rank	P <sub>O</sub> Rank	V <sub>F</sub> Rank
U0365	02	01

# Characteristics

PU88S01 UV Emitter  
 Product Specification

**Relative Radiant Flux vs. Forward Current**

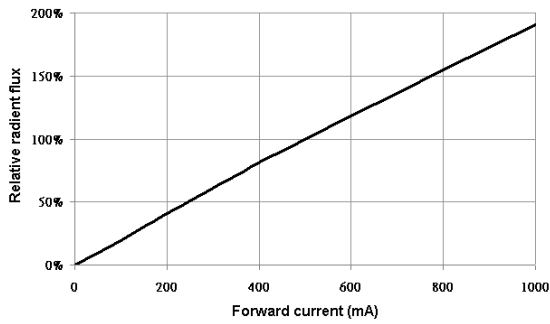

**Relative Spectral Distribution vs. Wavelength at 25°C, I<sub>F</sub>=500mA**

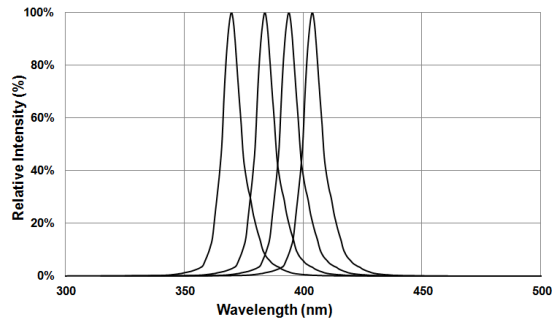

**Forward Current vs. Forward Voltage at 25°C**

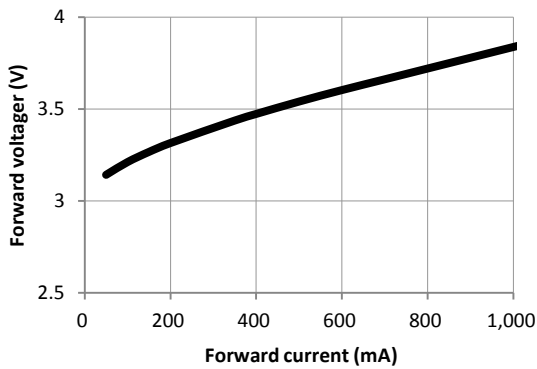

**Relative radiant flux vs. Ambient Temperature**

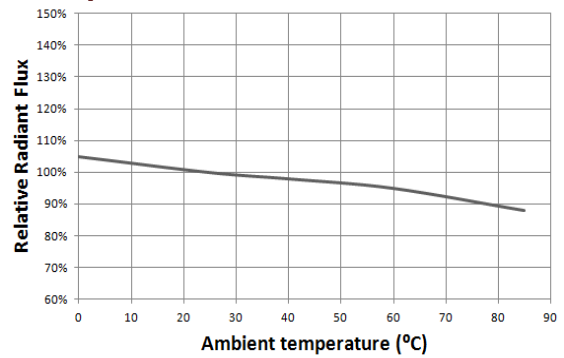

**Ambient Temperature vs. Allowable forward current**

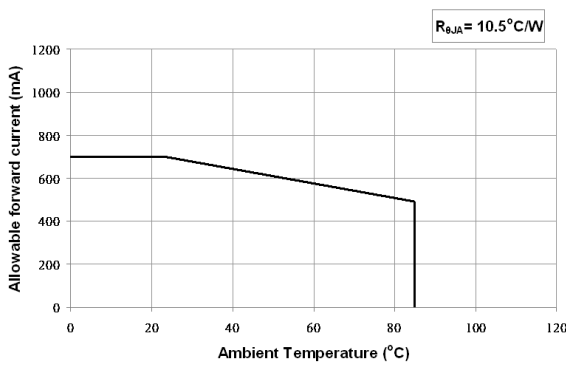

**Directivity**

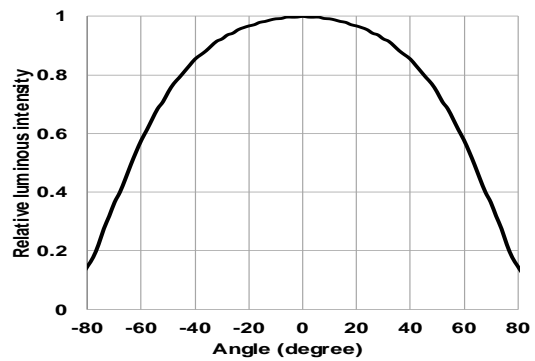

## Packing

PU88S01 UV Emitter  
Product Specification

### Label

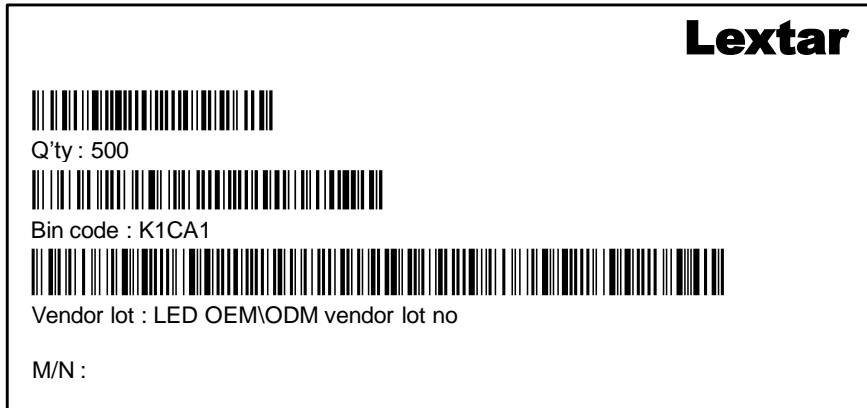

### Packing process

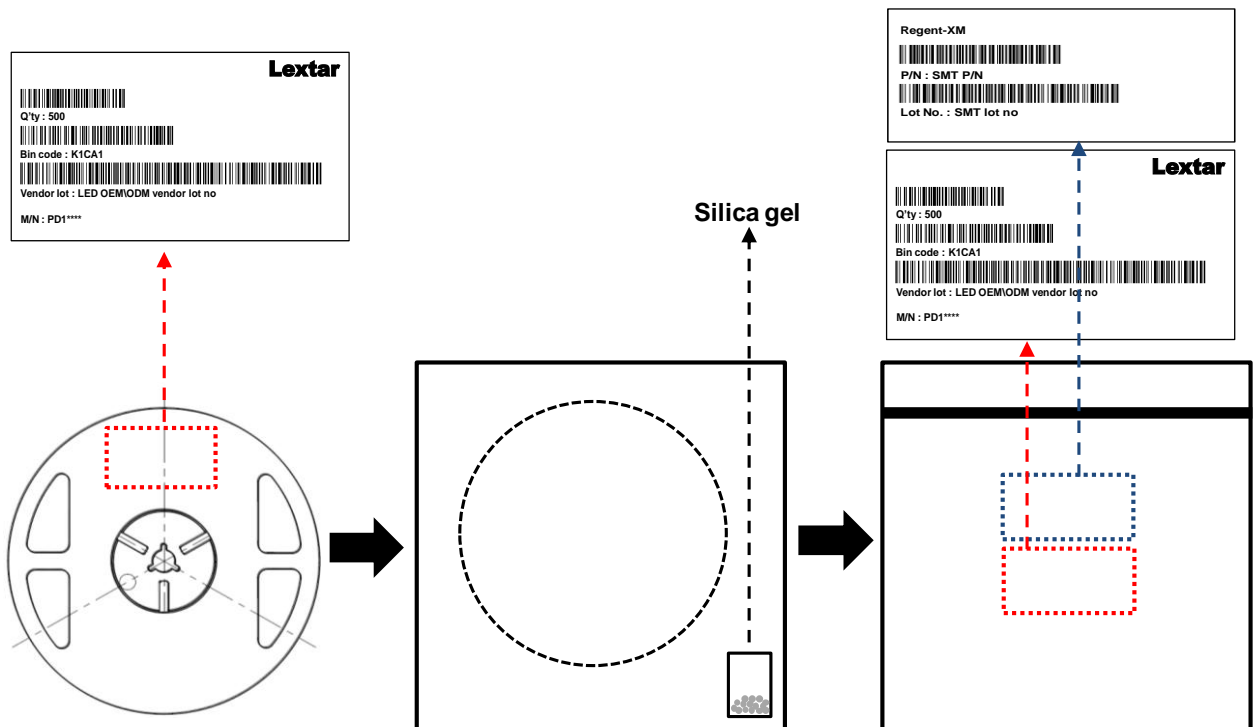

### Carrier dimensions

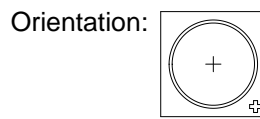
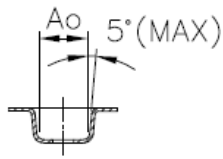
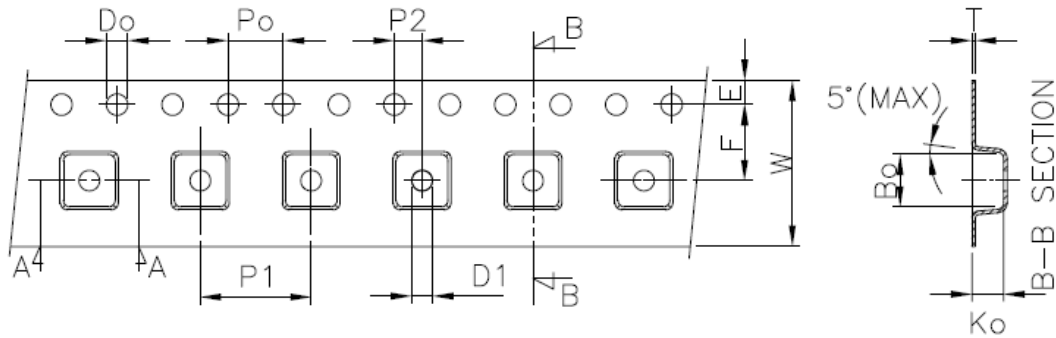

A-A SECTION

UNIT:mm

Symbol	$A_o$	$B_o$	$K_o$	$P_o$	$P_1$	$P_2$	$T$
Spec	$3.72 \pm 0.10$	$3.72 \pm 0.10$	$2.7 \pm 0.10$	$4.00 \pm 0.10$	$8.00 \pm 0.10$	$2.00 \pm 0.10$	$0.25 \pm 0.10$
Symbol	$E$	$F$	$D_o$	$D_1$	$W$	$10P_o$	--
Spec	$1.75 \pm 0.10$	$5.5 \pm 0.05$	$1.55 \pm 0.05$	$1.50 \pm 0.10$	$12.0 \pm 0.30$	$40.0 \pm 0.20$	--

USER REEL DIRECTION

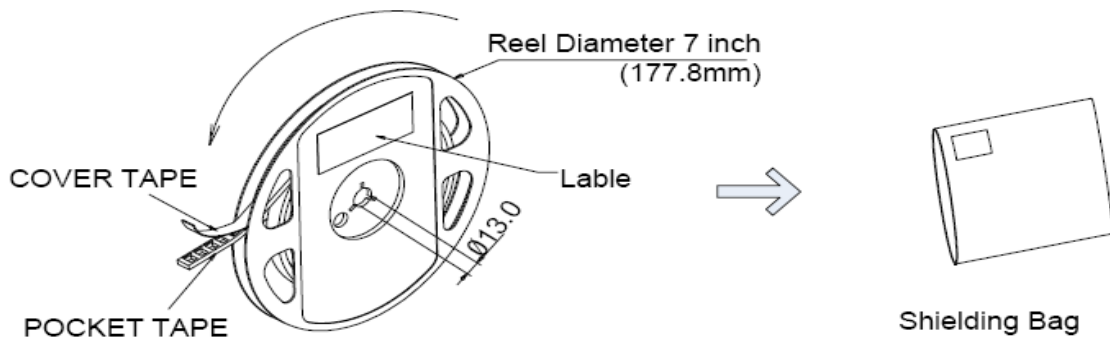

7 inch Anti-Static Reel

Max 500pcs/reel

Min 250pcs/reel



■ **Small Box**

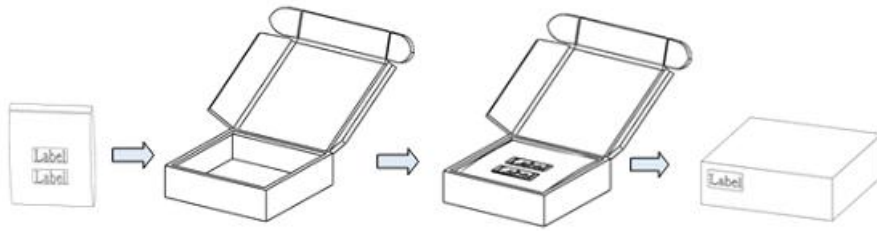

■ **Medium Box**

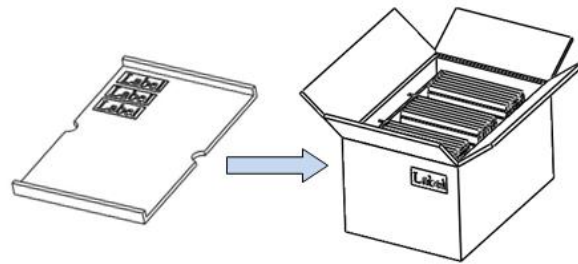
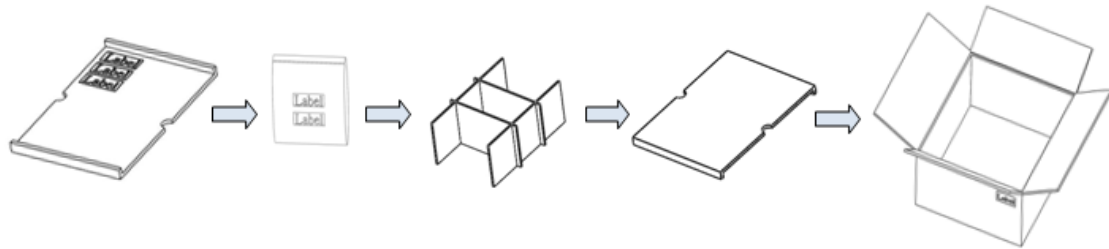

■ **Large Box**

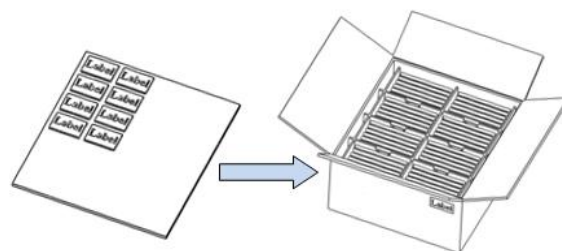
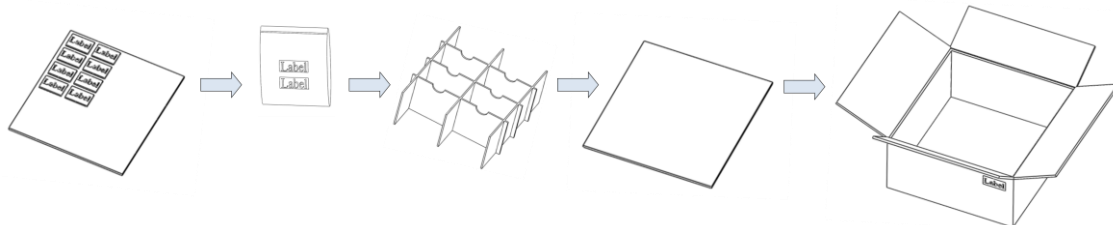

## Application Notes

PU88S01 UV Emitter  
Product Specification

### Soldering PAD Design

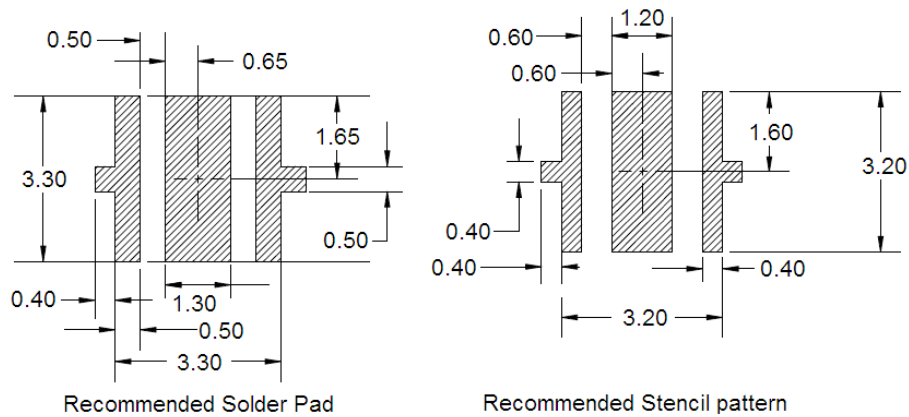

### Recommended Reflow Soldering Profile (JEDEC-STD-020 latest version compliant)

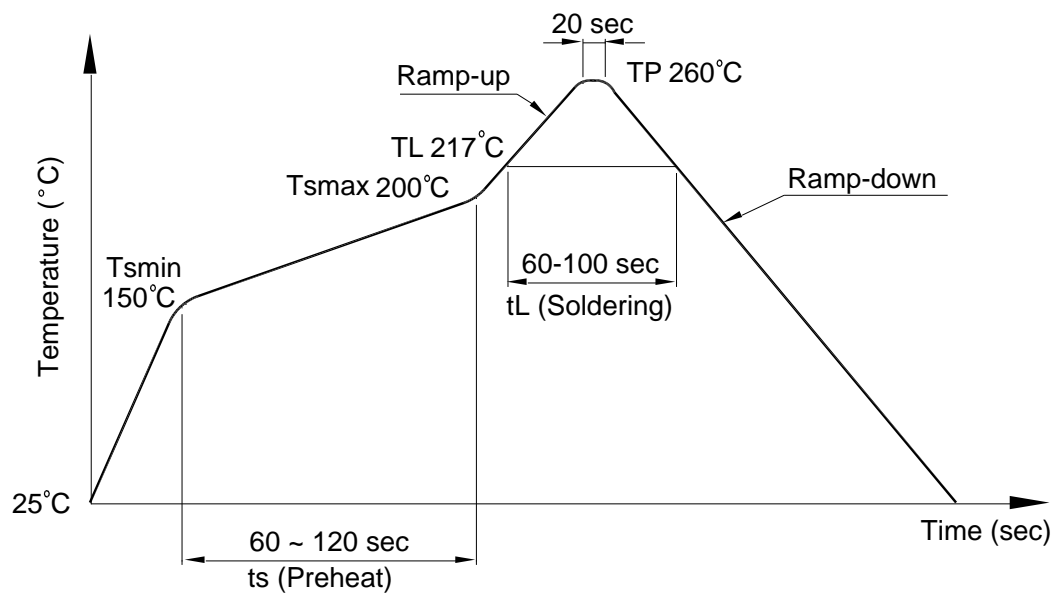

Profile Items	Conditions
Preheat	
-Temperature Min.( $T_{Smin}$ )	150°C
-Temperature Max.( $T_{Smax}$ )	200°C
-Time(Min. to Max.)( $t_S$ )	90±30 sec
Soldering Zone	
-Temperature( $T_L$ )	217°C
-Time	60~100 sec
Peak Temperature( $T_P$ )	260°C
Ramp-up rate	3°C / sec max.
Ramp-down rate	3~6°C / sec

**Note:**

1. One time soldering is recommended; do not exceed 3 times reflow process.
2. The recommended peak temperature is 245°C. The maximum soldering temperature should be controlled under 260°C.