



# PJS6631

## 20V P- MOSFET Load Switch with Level Shift & Adjustable Slew Rate

**Voltage**      **20 V**      **Current**      **2.0A**

### Features

- Vdrop = 0.2V@Vin=12V, IL=2.0A, RDS(ON)= 100mΩ
- Vdrop = 0.2V@Vin=5.0V, IL=1.8A, RDS(ON)= 110mΩ
- Vdrop = 0.2V@Vin=2.5V, IL=1.4A, RDS(ON)= 140mΩ
- Advanced Trench Process Technology
- Adjustable Turn on/off Slew Rate Control through external R1, R2 and C1.
- Lead free in compliance with EU RoHS 2011/65/EU directive.
- Green molding compound as per IEC61249 Std. (Halogen Free)

### Mechanical Data

- Case: SOT-23 6L Package
- Terminals: Solderable per MIL-STD-750, Method 2026
- Approx. Weight: 0.0005 ounces, 0.014 grams
- Marking: SL1

SOT-23 6L      Unit : inch(mm)

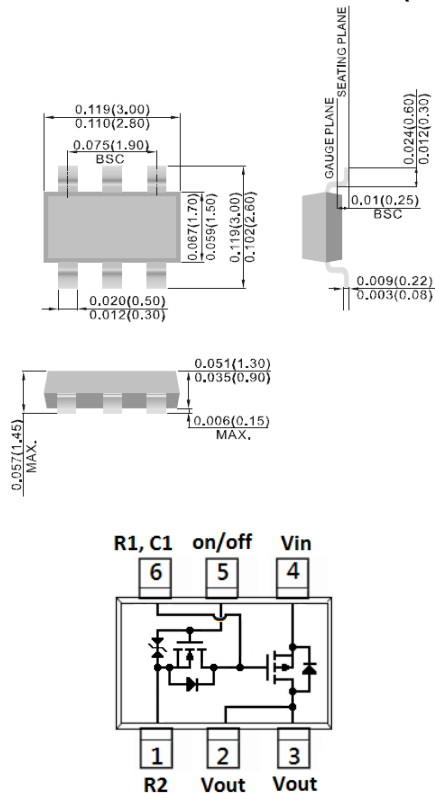

### Maximum Ratings and Thermal Characteristics (T<sub>A</sub>=25°C unless otherwise noted)

PARAMETER	SYMBOL	Ratings	UNITS
Input Voltage Range <sup>(Note 1)</sup>	V <sub>IN</sub>	20	V
On/Off Voltage Range	V <sub>ON</sub> /V <sub>OFF</sub>	12	V
Continuous Load Current t <sup>(Note 2,3)</sup>	I <sub>D</sub>	2	A
Pulsed Load Current <sup>(Note 4)</sup>	I <sub>D</sub>	8	A
Power Dissipation <sup>(Note 2)</sup>	P <sub>D</sub>	0.83	W
Operating Junction and Storage Temperature Range	T <sub>J</sub> , T <sub>STG</sub>	-55~150	°C
ESD, MIL-STD-883D HBM (100pF/1.5kohm) (Von/off pin)	V <sub>ESD</sub>	2	kV
Typical Junction to Ambient <sup>(Note 2)</sup>	R <sub>θJA</sub>	150	°C/W



# PJS6631

## Electrical Characteristics ( $T_A=25^{\circ}\text{C}$ unless otherwise noted)

PARAMETER	SYMBOL	TEST CONDITION	MIN.	TYP.	MAX.	UNITS
<b>Off Characteristics</b>						
Leakage Current	$I_{FL}$	$V_{IN}=20\text{V}, V_{ON}/V_{OFF}=0\text{V}$	-	-	1	$\mu\text{A}$
Diode Forward Voltage	$V_{SD}$	$I_S=-1.0\text{A}$	-	-0.76	-1.2	V
<b>On Characteristics</b>						
Input Voltage Range	$V_{IN}$		2.5	-	20	V
On/Off Voltage Range	$V_{ON}/V_{OFF}$		2.5	-	12	V
Drain-Source On-State Resistance ( $Q_2$ )	$R_{DS(on)}$	$V_{GS}=-12\text{V}, I_D=-2.0\text{A}$	-	84	100	m $\Omega$
		$V_{GS}=-5.0\text{V}, I_D=-1.8\text{A}$	-	90	110	
		$V_{GS}=-2.5\text{V}, I_D=-1.4\text{A}$	-	110	140	

**NOTES :**

- $V_{IN}$  Range can be up to 20V, but R1 and R2 must be scaled such that  $V_{GS}$  do not exceed 12V.
- $R_{\theta JA}$  is the sum of the junction-to-case and case-to-ambient thermal resistance where the case thermal reference is defined as the solder mounting surface of the drain pins mounted on a 1 inch FR-4 with 2oz. square pad of copper
- The maximum current rating is package limited
- Pulse test: pulse width  $\leq 300\mu\text{s}$ , duty cycle  $\leq 2\%$

## Application Circuits

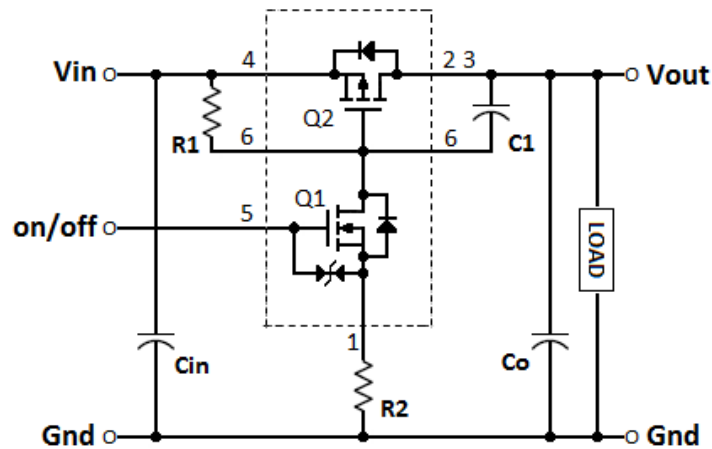

Component Table		
R1	Pull-Up Resistor	Typical 10k $\Omega$ to 1M $\Omega$
R2	Optional Slew-Rate Control	Typical 0k $\Omega$ to 100k $\Omega$
C1	Optional Slew-Rate Control	Typical 1 $\mu\text{F}$
<b>Note:</b> R1 should be at least 10 * R2 to ensure Q1 turn-on		



# PJS6631

## TYPICAL CHARACTERISTIC CURVES

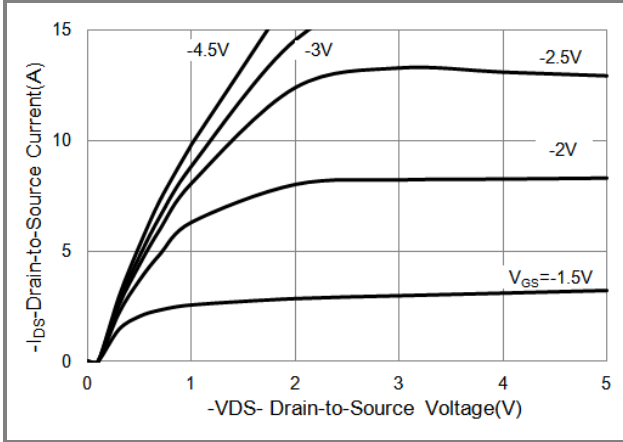

**Fig.1 Output Characteristics**

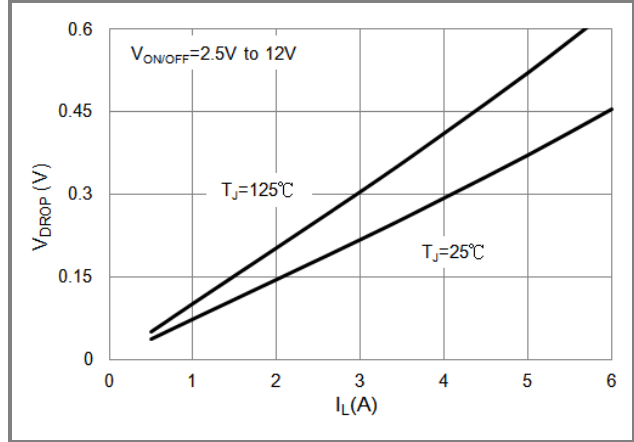

**Fig.2 Vdrop vs Load Current at Vin= 12V**

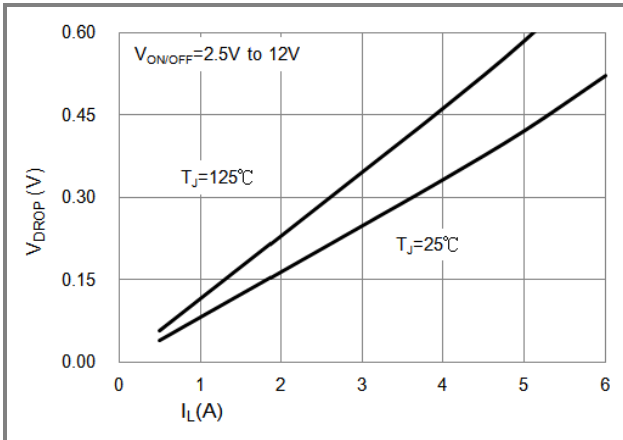

**Fig.3 Vdrop vs Load Current at Vin= 4.5V**

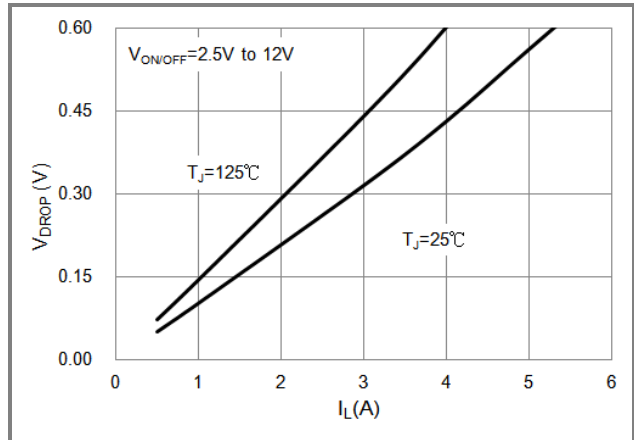

**Fig.4 Vdrop vs Load Current at Vin= 2.5V**

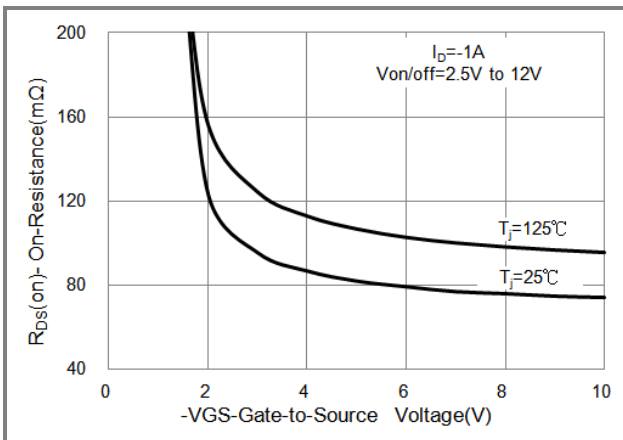

**Fig.5 On-Resistance Variation with VGS.**

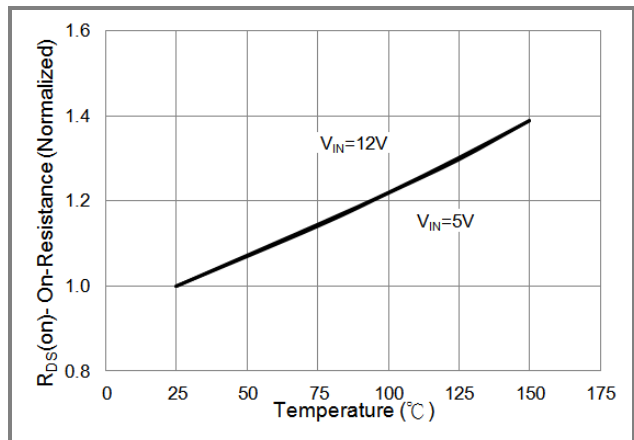

**Fig.6 Normalize Rds(on) vs Junction Temperature**



# PJS6631

## TYPICAL CHARACTERISTIC CURVES

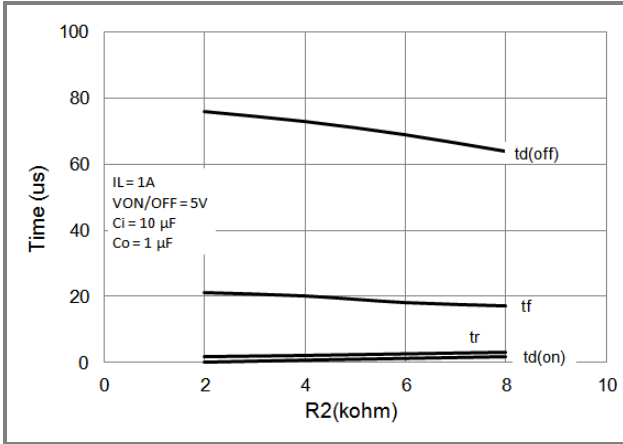

Fig.7 Switching Variation R2 at Vin=12V, R1=20k

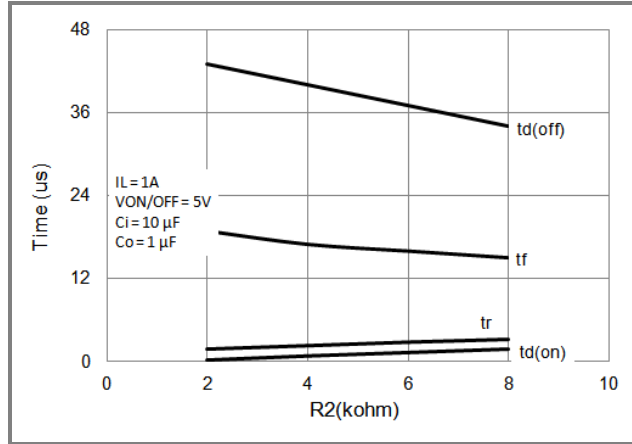

Fig.8 Switching Variation R2 at Vin=5V, R1=20k

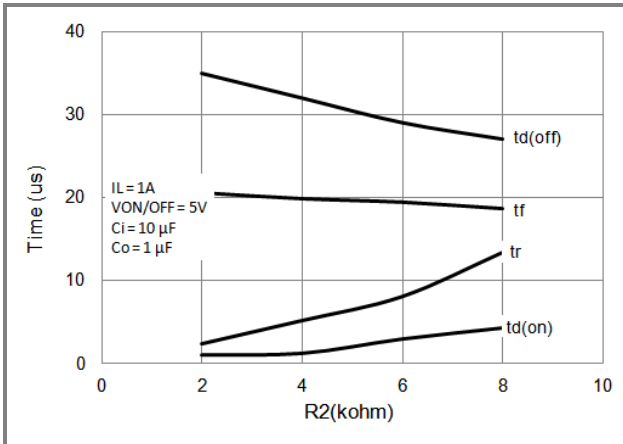

Fig.9 Switching Variation R2 at Vin=3.3V, R1=20k

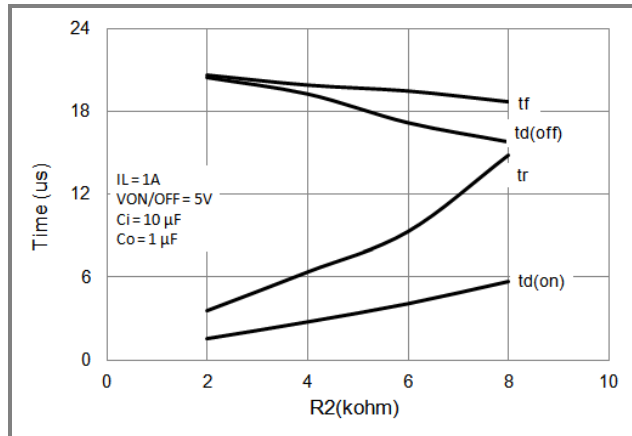

Fig.10 Switching Variation R2 at Vin=2.5V, R1=20k

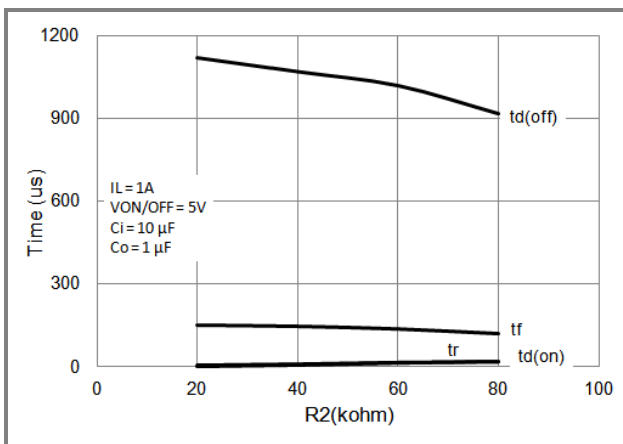

Fig.11 Switching Variation R2 at Vin=12V, R1=300k

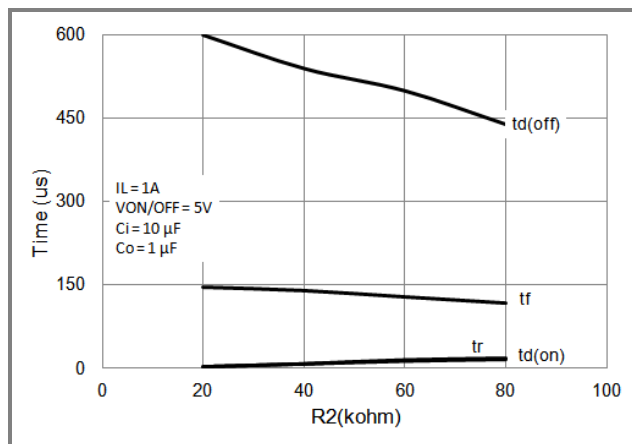

Fig.12 Switching Variation R2 at Vin=5V, R1=300k



# PJS6631

## TYPICAL CHARACTERISTIC CURVES

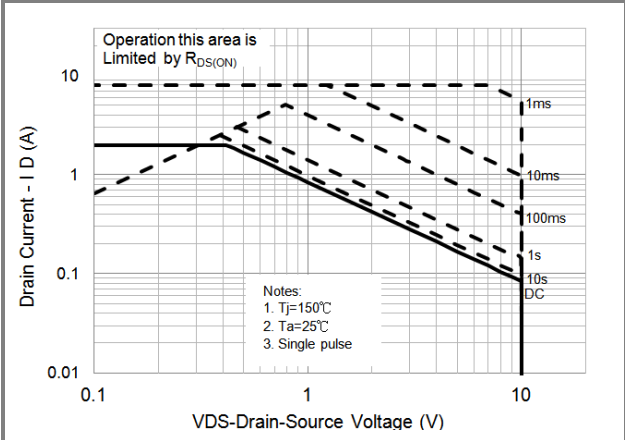

Fig.13 Switching Variation R2 at  $V_{in}=12\text{V}$ ,  $R_1=20\text{k}\Omega$

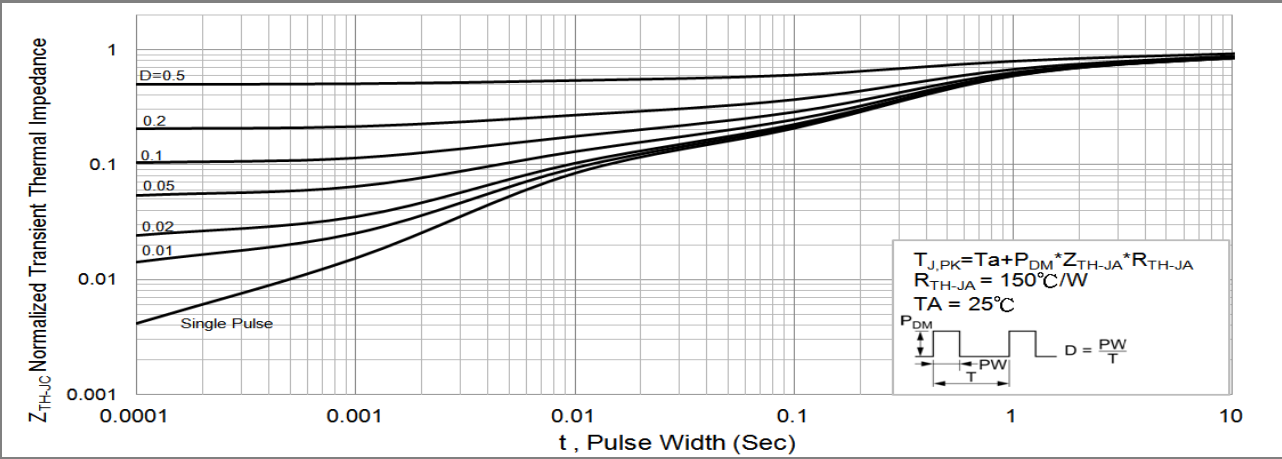

Fig.14 Transient Thermal Response Curve



# PJS6631

## PART NO PACKING CODE VERSION

Part No Packing Code	Package Type	Packing type	Marking	Version
PJS6631_S1_00001	SOT-23 6L	3K pcs / 7" reel	SL1	Halogen free
PJS6631_S2_00001	SOT-23 6L	10K pcs / 13" reel	SL1	Halogen free

## MOUNTING PAD LAYOUT

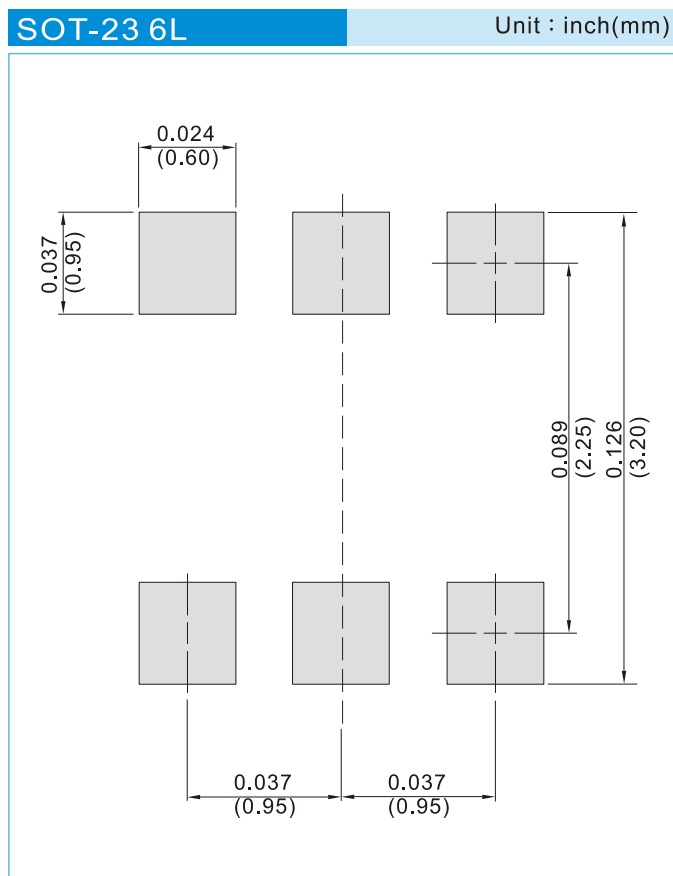



## PJS6631

### Disclaimer

- Reproducing and modifying information of the document is prohibited without permission from Panjit International Inc..
- Panjit International Inc. reserves the rights to make changes of the content herein the document anytime without notification. Please refer to our website for the latest document.
- Panjit International Inc. disclaims any and all liability arising out of the application or use of any product including damages incidentally and consequentially occurred.
- Panjit International Inc. does not assume any and all implied warranties, including warranties of fitness for particular purpose, non-infringement and merchantability.
- Applications shown on the herein document are examples of standard use and operation. Customers are responsible in comprehending the suitable use in particular applications. Panjit International Inc. makes no representation or warranty that such applications will be suitable for the specified use without further testing or modification.
- The products shown herein are not designed and authorized for equipments requiring high level of reliability or relating to human life and for any applications concerning life-saving or life-sustaining, such as medical instruments, transportation equipment, aerospace machinery et cetera. Customers using or selling these products for use in such applications do so at their own risk and agree to fully indemnify Panjit International Inc. for any damages resulting from such improper use or sale.
- Since Panjit uses lot number as the tracking base, please provide the lot number for tracking when complaining.