

SPECIFICATIONS

Current Rating: 3 AMP
 Insulation Resistance: 1000MΩ Min.
 Contact Resistance: 30mΩ Max.
 Dielectric Voltage: 500V AC for one minute
 Operation Temperature: -55°C to +105°C

MATERIAL

Insulator: PBT+30% G. F., UL94V-0
 Contact Pin: Copper Alloy

ORDER INFORMATION

5 7 D B D S X M - X X X X X X X A - X X

1: Tin shell + L(RoHS)
 2: Nickel shell + L(RoHS)

M: Male

No. of contacts

N: Non Type
 B: With Boardlock
 C: With Boardlock Screw Insert

N: Clear Hole
 A: Thread Insert #4-40
 + Jack Screw #4-40 Attached
 C: Thread Insert #4-40
 + Jack Screw #4-40 Removable
 H: Front Rivet #4-40, H:5.8
 J: Front Rivet M3, H:5.8
 F: Rear Rivet #4-40, H:4.0
 G: Rear Rivet M3, H:4.0
 L: Rear Rivet 4.0mm
 + Jack Screw #4-40 Removable
 I: Rear Rivet #4-40, H:2.5

G0: Gold Flash	S0: Selective
GA: 5u"	SA: 5u"
GB: 10u"	SB: 10u"
GC: 20u"	SC: 20u"
GD: 30u"	SD: 30u"

W: White
 B: Black
 U: Blue

A: Tray

01: H=4.0
 02: H=4.6

⊙: Standard Recommend

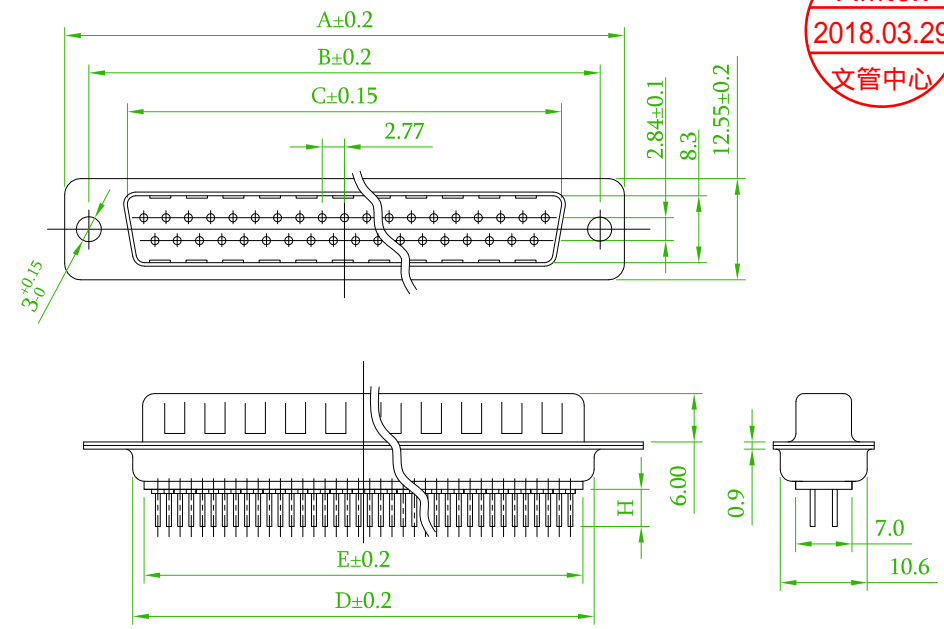
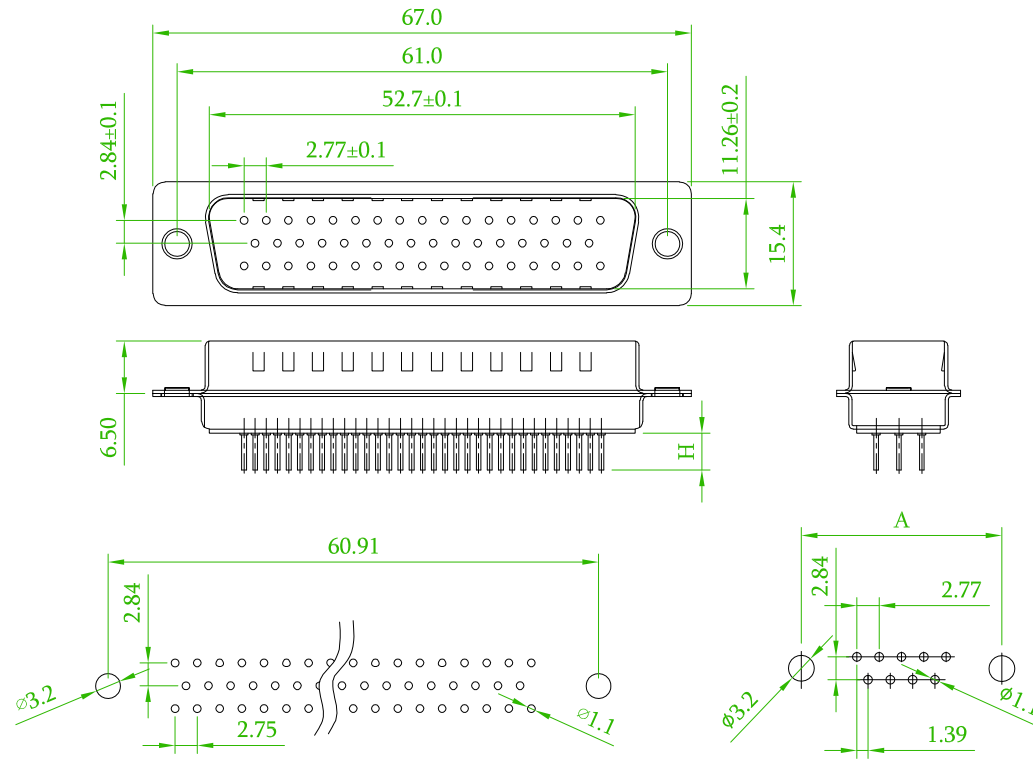

For 50 Pin

For Other Pins

Recommended PCB Layout
 (PCB TOLERANCE ±0.1)

Old Part No.: DBD-MXX-L

△x1	Add 50 Pin.	Gary	2018/03/28
△x1	Revise the BB Type.	Roy	2016/11/18
REV.	ECN NO. OR DESCRIPTION	REVISED	DATE

<p>Amtek Technology Co., Ltd. TEL: 886-2-2260-6878 FAX: 886-2-2260-8030</p>	品名 TITLE	D-SUB V/T DIP TYPE			頁數 Page	1/2
	品號 PART NO.	57DBDSXM-XXXXXXXXA-XX			繪圖 DRAWN	Roy
	圖號 DRAWING NO.	GN010-RL085	版本 REV.	C	核對 CHECKED	Josh
	客戶品號 CUSTOMER P/N		比例 SCALE	None	承認 APPROVED	Jason
	公差 TOLERANCE	.X ±0.20 .XX ±0.15	單位 UNIT	mm	THIRD ANGLE PROJECTION	

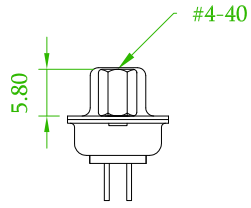

Front Rivet #4-40, H:5.8
57DBDSXM-XXNHXXXXA-XX

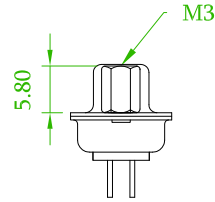

Front Rivet M3, H:5.8
57DBDSXM-XXNJXXXXA-XX

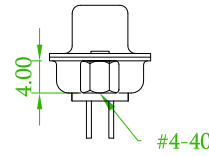

Rear Rivet #4-40, H:4.0
57DBDSXM-XXNFXXXXA-XX

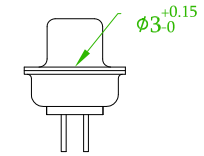

Clear Hole
57DBDSXM-XXNNXXXXA-XX

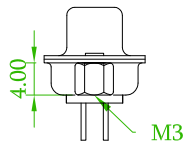

Rear Rivet M3, H:4.0
57DBDSXM-XXNGXXXXA-XX

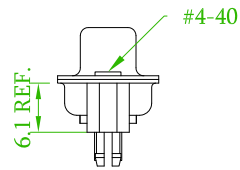

With Boardlock
+Thread Insert #4-40
57DBDSXM-XXBAXXXA-XX

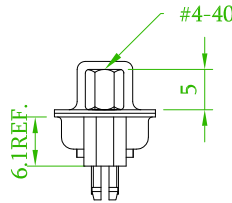

With Boardlock
+Thread Insert #4-40
+Jack Screw #4-40 Removable
57DBDSXM-XXCCXXXXA-XX

CON.	A	B	C	D	E
9	30.81	24.99	16.90	19.28	15.60
15	39.14	33.32	25.10	27.65	24.60
25	53.04	47.04	38.91	41.10	37.70
37	69.32	63.50	55.25	57.44	54.50

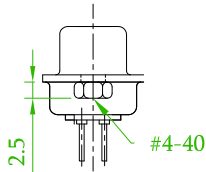

Rear Rivet #4-40, H:2.5
57DBDSXM-XXN1XXXXA-XX

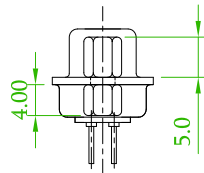

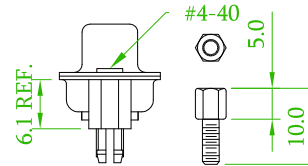

Rear Rivet 4.0mm
+ Jack Screw #4-40 Removable
57DBDSXM-XXNLXXXXA-XX



With Boardlock
+Thread Insert #4-40
+ Jack Screw #4-40 Attached 
57DBDSXM-XXBBXXXXA-XX

Old Part No.:DBD-MXX-L

REV.	ECN NO. OR DESCRIPTION	REVISED	DATE
 x1	Add 50 Pin.	Gary	2018/03/28
 x1	Revise the BB Type.	Roy	2016/11/18

 Amtek Technology Co., Ltd. TEL: 886-2-2260-6878 FAX: 886-2-2260-8030	品名 TITLE	D-SUB V/T DIP TYPE			頁數 Page	2/2
	品號 PART NO.	57DBDSXM-XXXXXXXXA-XX			繪圖 DRAWN	Roy
	圖號 DRAWING NO.	GN010-RL085	版本 REV.	C	核對 CHECKED	Josh
	客戶品號 CUSTOMER P/N		比例 SCALE	None	承認 APPROVED	Jason
	公差 TOLERANCE	.X ±0.20 .XX ±0.15	單位 UNIT	mm	THIRD ANGLE PROJECTION	