

SWITCH CIRCUIT

MATERIAL AND FINISH AS BELOW

WHEN CARD IS EJECTED

WHEN CARD IS INSERTED

A	Housing	LCP UL94V-0 Black	E	
B	Contact	Phosphor Bronze C5210, Contact Area: Gold Flash	F	
C	Latch	Stainless Steel SUS301	G	
D			H	



NOTES:
 DATE CODE 2202 (YWWDD)
 Y: 2 YEAR(2012)
 WW:20 WEEK(01~52)
 D: 2 DAY(01~07)

SPECIFICATION:

1. ELECTRICAL

- 1.1 Current Rating: 0.5A per pin
- 1.2 Voltage Rating: 25V AC/DC
- 1.3 Contact Resistance: 60mΩ
- 1.4 Insulation Resistance: 500MΩ
- 1.5 Dielectric Withstanding Voltage: 125VAC

2. MECHANICAL

- 2.1 Durability: 25 Cycle
- 2.2 Latch Retention Force: 8 N/Pos. Min

3. ENVIRONMENTAL

- 3.1 Operating temperature range: -40°C~+85°C
- 3.2 Storage temperature range: -40°C~+85°C

4. SOLDER ABILITY

- 4.1 Recommended IR Reflow Temperature: 255°C 10Sec

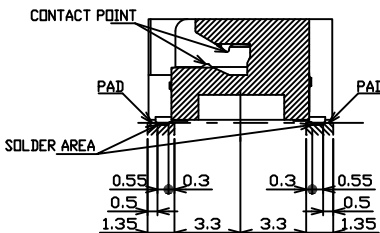
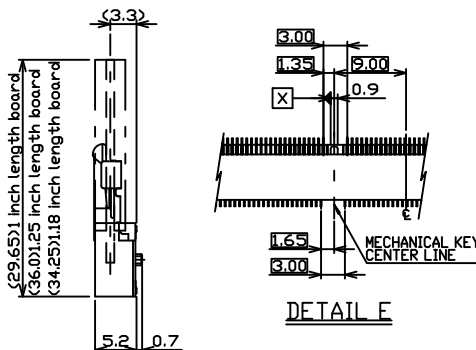
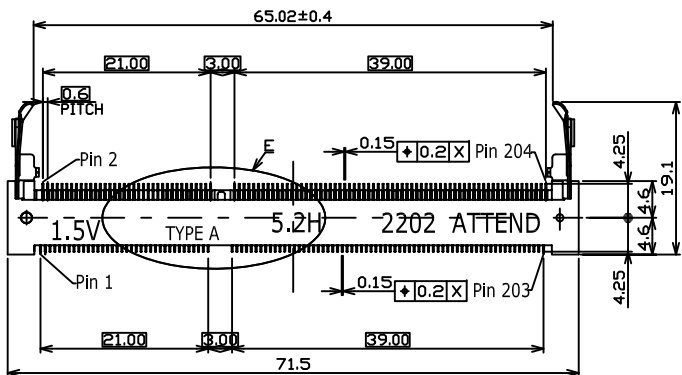

P1	P2	P3	P4	P5	P6	P7	P8	P9	P10	P11	P12
----	----	----	----	----	----	----	----	----	-----	-----	-----

PIN ASSIGNMENT

122A-52A00 SO DIMM DDR3 Socket 1.5V 204Pin Type 5.2H, Contact Area: Gold Flash

PRODUCT NO. DESCRIPTION

UNLESS OTHERWISE SPECIFIED TOLERANCE

ANGLES	ANG.	±5°
LINEAR	0.	±0.3
	0.0	±0.25
	0.00	±0.20

SCALE AS SHOWN UNIT: mm

DRAWN Willis 2012/12/05

CHECKED Angel 2012/12/05

APPROVED Ken 2012/12/05



www.attend.com.tw

DRAWN NAME: SO DIMM DDR3 Socket 1.5V 204Pin 5.2H Type

PRODUCT NO. 122A-52A00

FILE NAME 122A-52A00_B_1

- △ Revise:
- △ Revise:
- △ Revise:

REV.	DESCRIPTION	DATE	REV.	DESCRIPTION	DATE	SIZE	REV.	FILE NAME
1			4			A4	1.0	122A-52A00_B_1

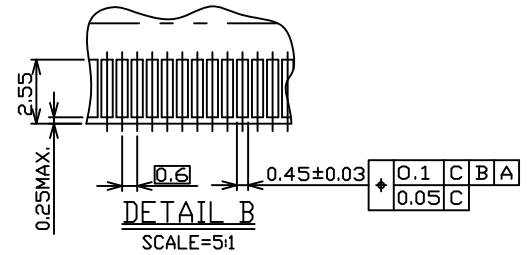
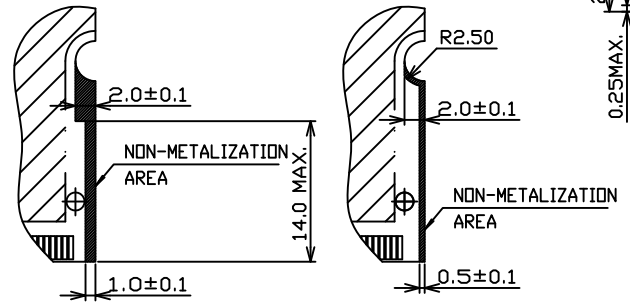
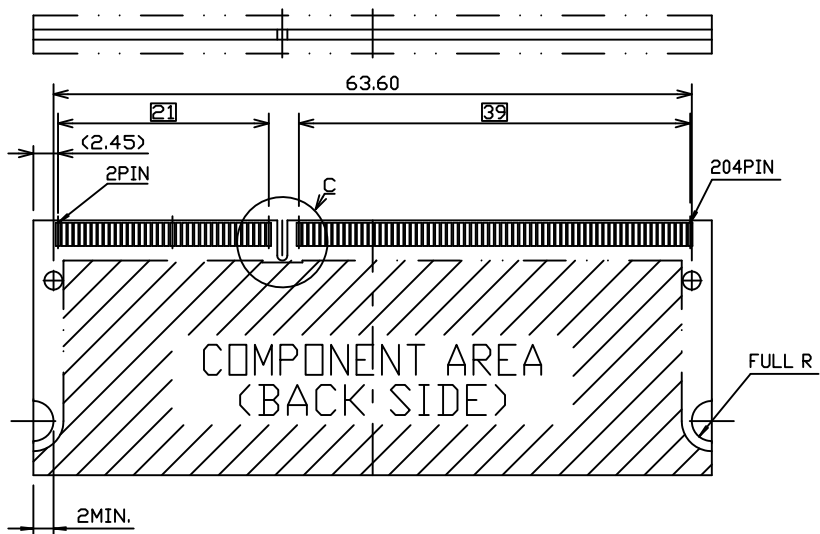
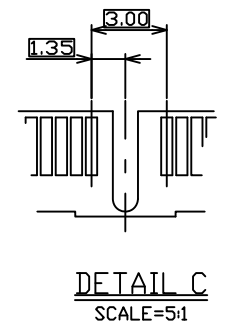
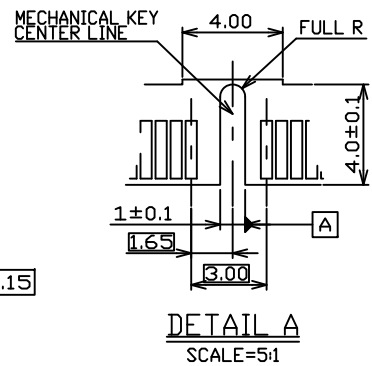
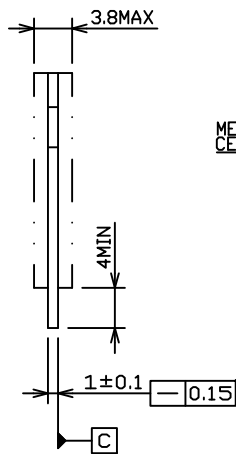
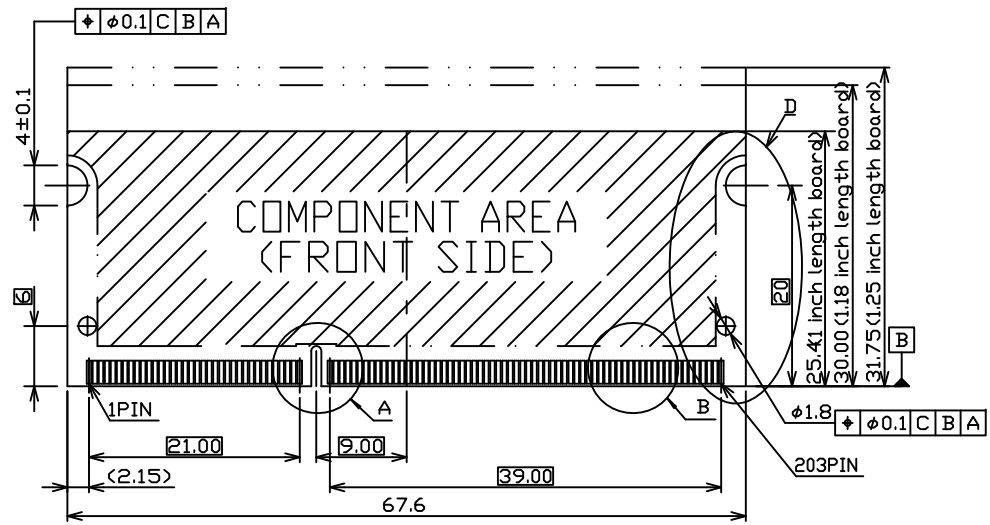

RECOMMENDED MATING
P.C. BOARD DIM.

						UNLESS OTHERWISE SPECIFIED TOLERANCE			 www.attend.com.tw	
						ANGLES	ANG.	±5°		
						LINEAR	0.	±0.3		
							0.0	±0.25		
						0.00	±0.20			
						SCALE	AS SHOWN	UNIT: mm		
						DRAWN	Willis	2012/12/05	DRAWN NAME: SO DIMM DDR3 Socket 1.5V 204Pin 5.2H Type	
						CHECKED	Angel	2012/12/05		
						APPROVED	Ken	2012/12/05	PRODUCT NO. 122A-52A00	
REV.	DESCRIPTION	DATE	REV.	DESCRIPTION	DATE	SIZE A4	REV. 1.0	FILE NAME 122A-52A00_B_1		

Revise:
Revise:
Revise:

A

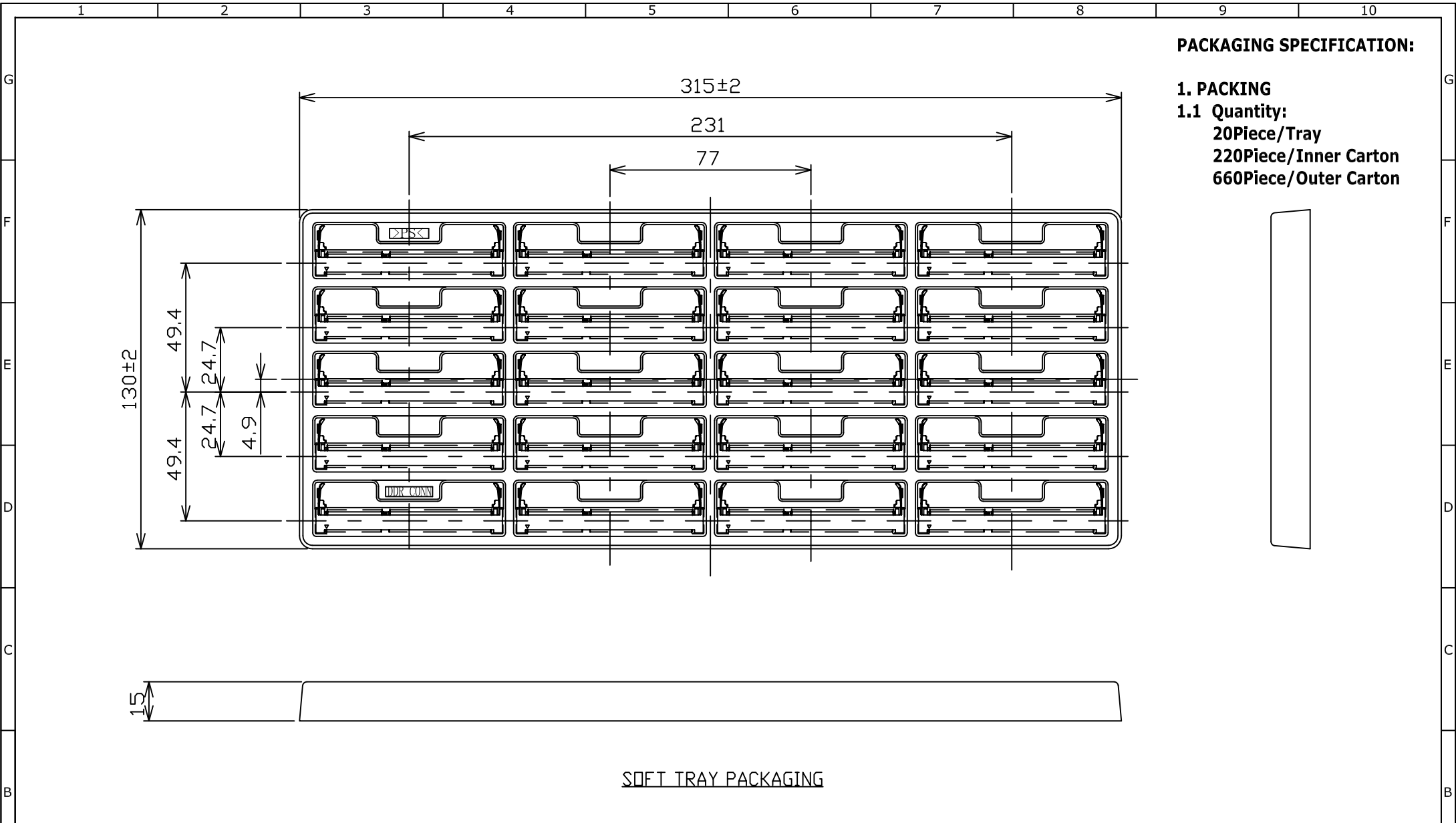

PACKAGING SPECIFICATION:

- 1. PACKING**
- 1.1 Quantity:**

 - 20Piece/Tray
 - 220Piece/Inner Carton
 - 660Piece/Outer Carton



						UNLESS OTHERWISE SPECIFIED TOLERANCE			 www.attend.com.tw	
						ANGLES	ANG.	±5°		
						LINEAR	0.	±0.3		
							0.00	±0.25		
						SCALE	AS SHOWN	UNIT: mm	±0.20	
						DRAWN	Willis	2012/12/05	DRAWN NAME: SO DIMM DDR3 Socket 1.5V 204Pin 5.2H Type	
						CHECKED	Angel	2012/12/05		
						APPROVED	Ken	2012/12/05	PRODUCT NO.	122A-52A00
REV.	DESCRIPTION		DATE	REV.	DESCRIPTION		DATE	SIZE	REV.	FILE NAME
1				4				A4	1.0	122A-52A00_D_1

- △ Revise:
- △ Revise:
- △ Revise: