

Approval Sheet

(產品承認書)

產品名稱 (Product): BT 4.2 & BT 5 Module (nRF52832)

產品型號 (Model No.): MDBT42Q – 512KV2 (Chip Antenna)

MDBT42Q – P512KV2 (PCB Antenna)

產品料號 (Part No.): [see 4.3 Order Code](#)

Advantage of MDBT42Q & MDBT42Q-P series:

- 1. Long working distance:
MDBT42Q: over 80 meters in open space.
MDBT42Q-P: up to 60 meters in open space.*
- 2. Declaration ID includes all Nordic applied profiles.*
- 3. Granted main regional certification such as FCC (USA), CE(EU)
TELEC (Japan), SRRC (China), IC (Canada), NCC (Taiwan),
and KC (South Korea)*

Index

1. Overall Introduction	4
1.1. Application	4
1.2. Features	5
1.3. Profile & Service Information	6
2. Product Dimension	7
2.1. PCB Dimensions & Pin Indication.....	7
2.2. Recommended Layout of Solder Pad.....	9
2.3. RF Layout Suggestion (aka Keep-Out Area)	14
2.4. Footprint & Design Guide	16
2.5. Pin Assignment.....	17
2.6. GPIO Located Near the Radio.....	19
3. Main Chip Solution.....	19
4. Shipment Packaging Information	20
4.1. Marking on Metal Shield	21
4.2. Packaging Info.....	21
4.3. Order Code.....	23
5. Specification	24
5.1. Absolute Maximum Ratings	24
5.2. Operation Conditions.....	24
5.3. Electrical Specifications.....	25
6. Block Diagram	30
7. Antenna	31
7.1. MDBT42Q Series	31
7.2. MDBT42Q-P Series.....	32
8. Reference Circuit.....	33
9. Certification	34
9.1. Declaration ID.....	34
9.2. FCC Certificate (USA)	36
9.3. TELEC Certificate (Japan).....	38
9.4. NCC Certificate (Taiwan)	40
9.5. CE Test Report (EU)	42
9.6. IC Certificate (Canada).....	44
9.7. SRRC Certificate (China).....	46

9.8. KC Certificate (South Korea)	47
9.9. RoHS & REACH Report	48
9.10. End-Product Label	48
10. Notes and Cautions.....	50
11. Basic Facts for nRF52 Chip.....	51
12. Useful Links	52
Full List of Raytac's BLE Modules	53
Release Note.....	56

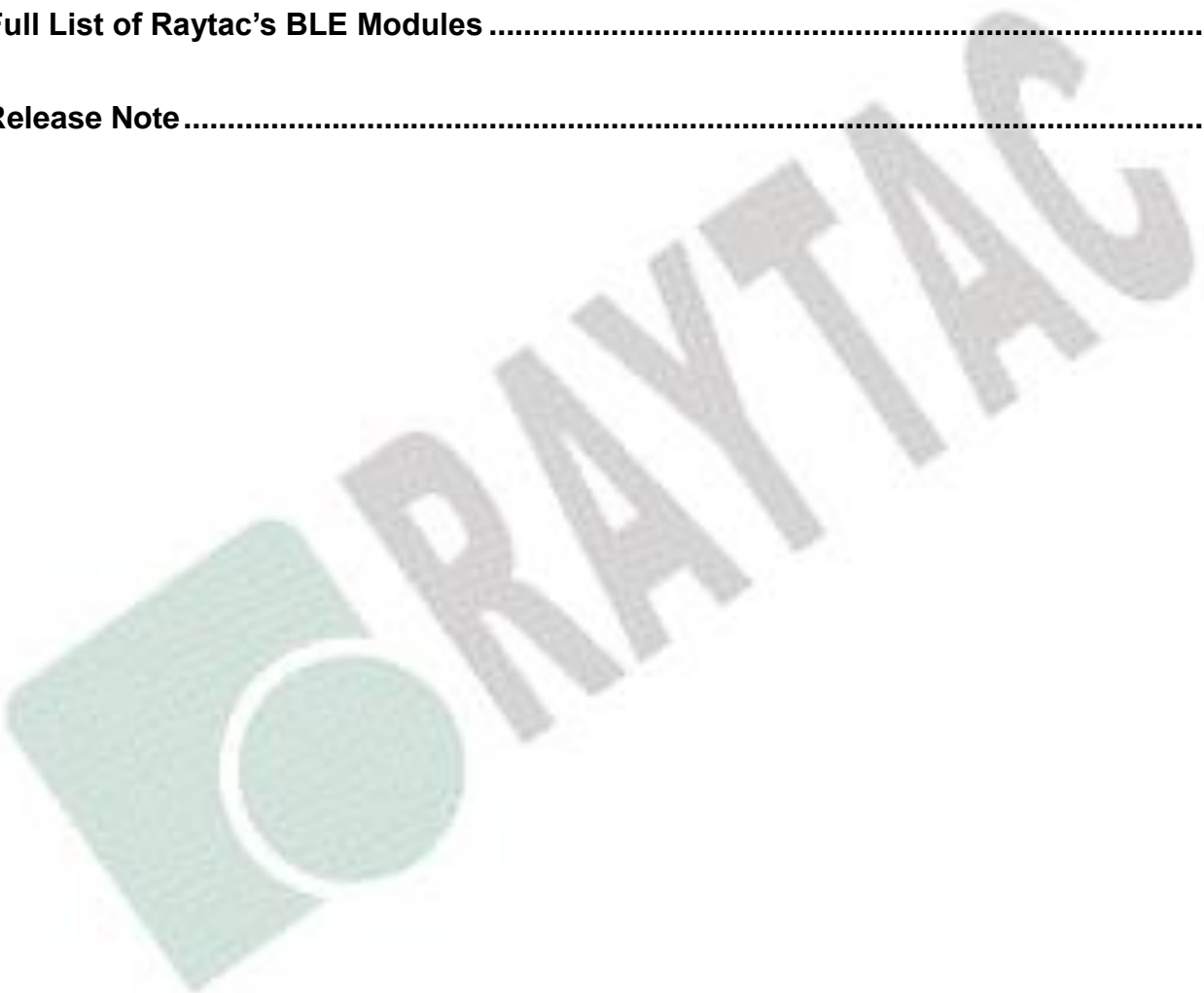

1. Overall Introduction

Raytac's MDBT42Q & MDBT42Q-P is a BT 4.2 and BT 5 stack (Bluetooth low energy or BLE) module designed based on **Nordic nRF52832 SoC solution**, which incorporates: **GPIO, SPI, UART, I2C, I2S, PWM, ADC** and **NFC** interfaces for connecting peripherals and sensors.

Features:

1. Dual Transmission mode of BLE & 2.4Ghz RF upon customer's preference.
2. Compact size with **(L) 16 x (W) 10 x (H) 2.2 mm**.
3. Low power requirements, ultra-low peak, average and idle mode power consumption.
4. Be compatible with a large installed base of mobile phones, tablets and computers.
5. Fully coverage of BLE software stack. See [1.3 Profile & Service Information](#)
6. BLE & RF transmission switching helps products fit all operation system and most hardware.

1.1. Application

- IoT
 - Home automation
 - Sensor networks
 - Building automation
- Personal Area Networks
 - Health / fitness sensor and monitor device
 - Medical devices
 - Key-fobs and wrist watches
- Interactive entertainment devices
 - Remote control
 - Gaming controller
- Beacons
- A4WP wireless chargers and devices
- Remote control toys
- Computer peripherals and I/O devices
 - Mouse
 - Keyboard
 - Multi-touch trackpad

1.2. Features

- Multi-protocol 2.4GHz radio
- 32-bit ARM Cortex – M4F processor
- 512KB flash programmed memory and 64KB RAM
- Software stacks available as downloads
- Application development independent from protocol stack
- On-air compatible with nRF51, nRF24AP and nRF24L series
- Programmable output power from +4dBm to -20dBm
- RSSI
- RAM mapped FIFOs using EasyDMA
- Dynamic on-air payload length up to 256 bytes
- Flexible and configurable 32 pin GPIO
- Programmable peripheral interface - PPI
- Simple ON / OFF global power mode
- Full set of digital interface all with Easy DMA including:
 - 3 x Hardware SPI master ; 3 x Hardware SPI slave
 - 2 x two-wire master ; 2 x two-wire slave
 - 1 x UART (CTS / RTS)
 - PDM for digital microphone
 - I2S for audio
- Quadrature demodulator
- 12-bit / 200KSPS ADC
- 128-bit AES ECB / CCM / AAR co-processor
- Low cost external crystal 32MHz \pm 40ppm for Bluetooth ; \pm 50ppm for ANT Plus
- Low power 32MHz crystal and RC oscillators
- Wide supply voltage range 1.7V to 3.6V
- On-chip DC/DC buck converter
- Individual power management for all peripherals
- Timer counter
 - 5 x 32-bit
 - 3 x 24-bit RTC
- Type 2 near field communication (NFC-A) tag with wakeup-on-field and touch-to-pair capabilities
- 3x 4-channel pulse width modulator (PWM) units with EasyDMA

1.3. Profile & Service Information

Profile & Service are supported by MDBT42Q & MDBT42Q-P as below:

Profile Description	Service Description
Alert Notification Profile	Alert Notification Service
Blood Pressure Profile	Blood Pressure Service
	Device Information Service
Cycling Speed & Cadence Profile	Cycling Speed & Cadence Service
	Device Information Service
Glucose Profile	Glucose Service
	Device Information Service
Health Thermometer Profile	Health Thermometer Service
	Device Information Service
Heart Rate Profile	Heart Rate Service
	Device Information Service
HID over GATT Profile	HID Service
	Battery Service
Proximity Profile	Link Loss Service
	Immediate Alert Service
	TX Power Service
Running Speed & Cadence Profile	Running Speed & Cadence Service
	Device Information Service
Time Profile	Time Profile Service
Glucose Profile (Central)	

2. Product Dimension

2.1. PCB Dimensions & Pin Indication

- **MDBT42Q**

PCB SIZE: (L) 16 x (W) 10 x (H) 2.2 mm

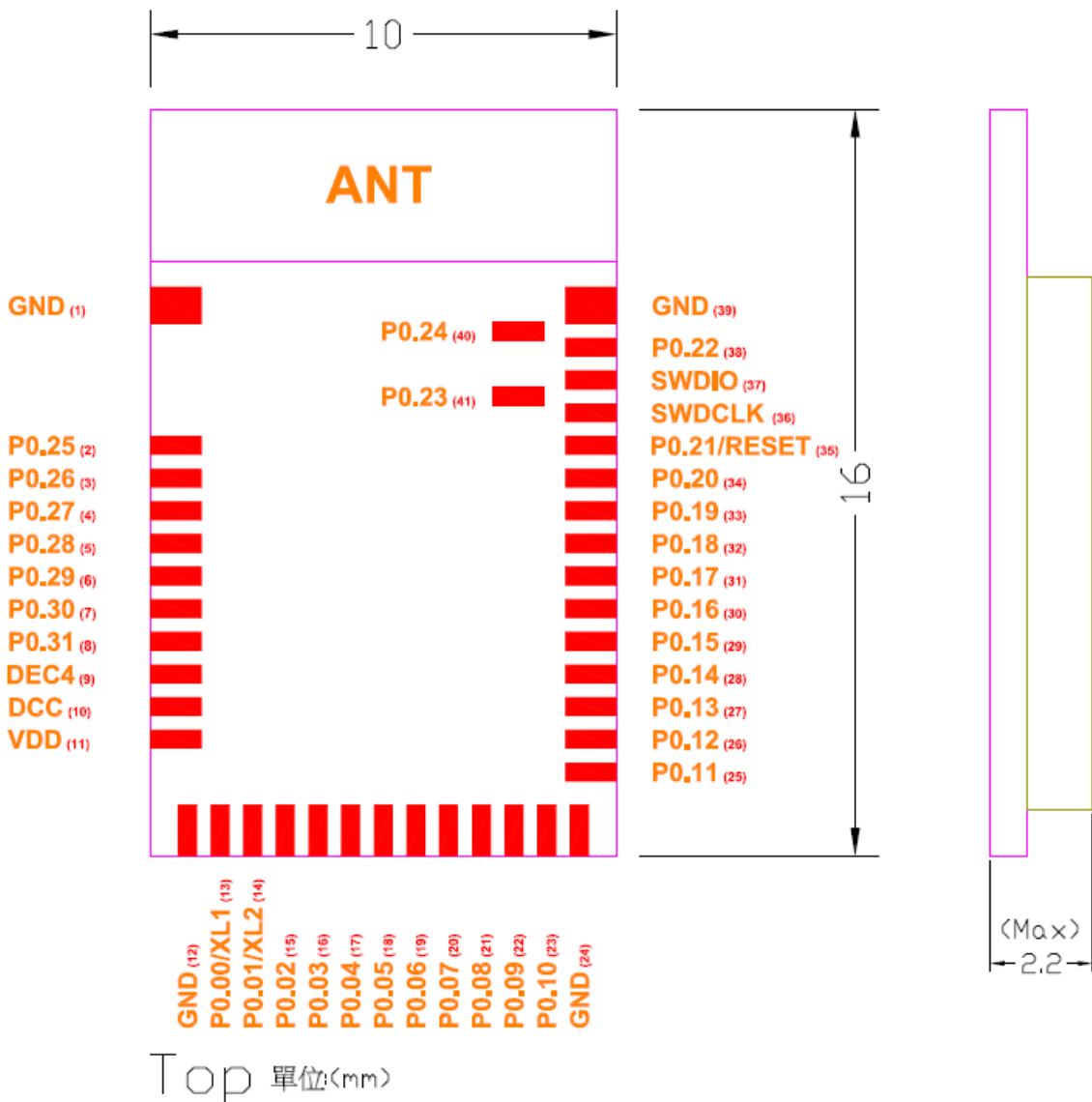

*** Please be careful of the amount of solder paste for P0.23 & P0.24. The module may be lifted due to excess solder. Pads for P0.23 & P0.24 can be omitted when two GPIOs were not used.**

• **MDBT42Q-P**

PCB SIZE: (L) 16 x (W) 10 x (H) 2.2 mm

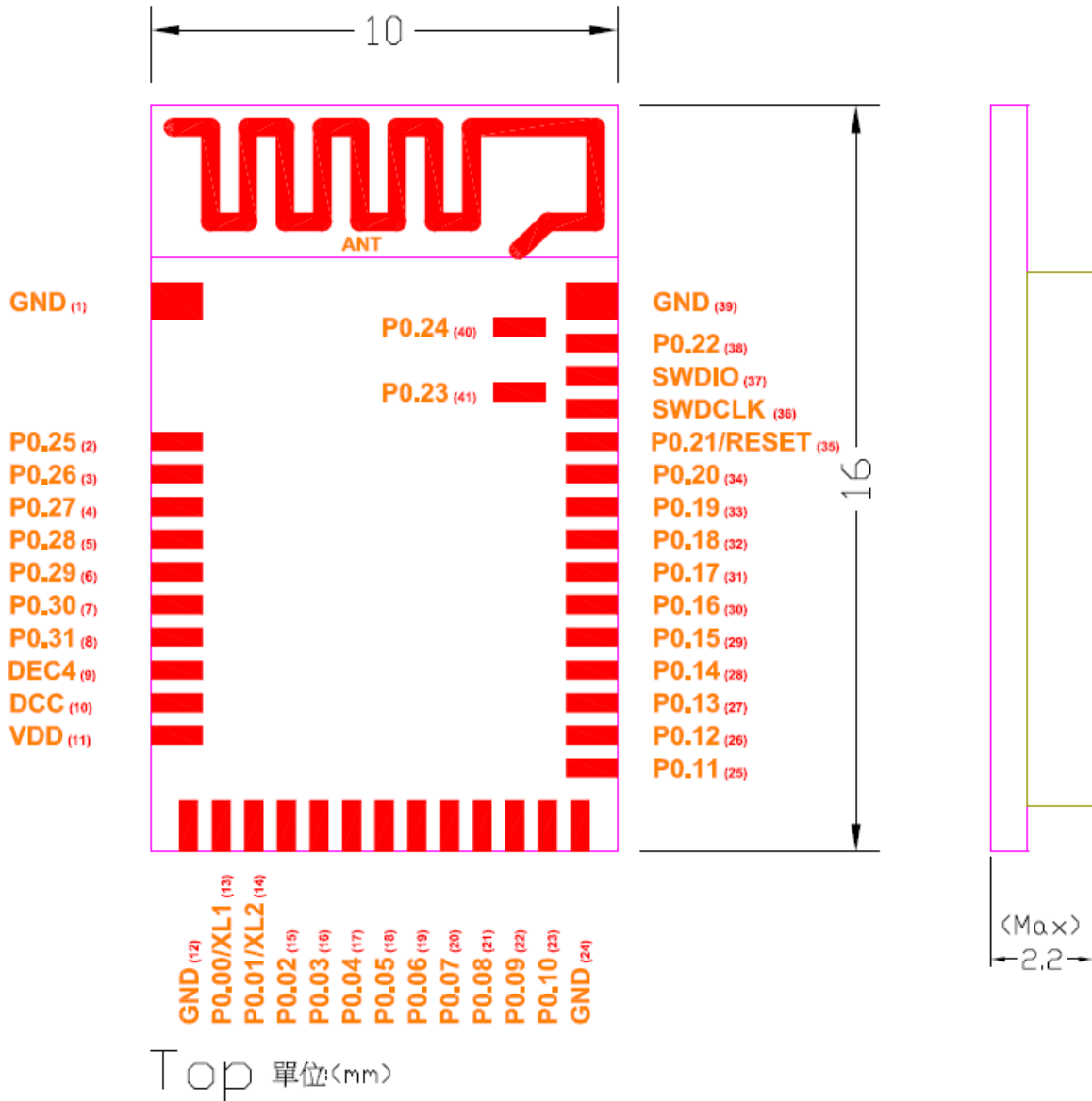

*** Please be careful of the amount of solder paste for P0.23 & P0.24. The module may be lifted due to excess solder. Pads for P0.23 & P0.24 can be omitted when two GPIOs were not used.**

2.2. Recommended Layout of Solder Pad

Graphs are all in Top View, Unit in mm.

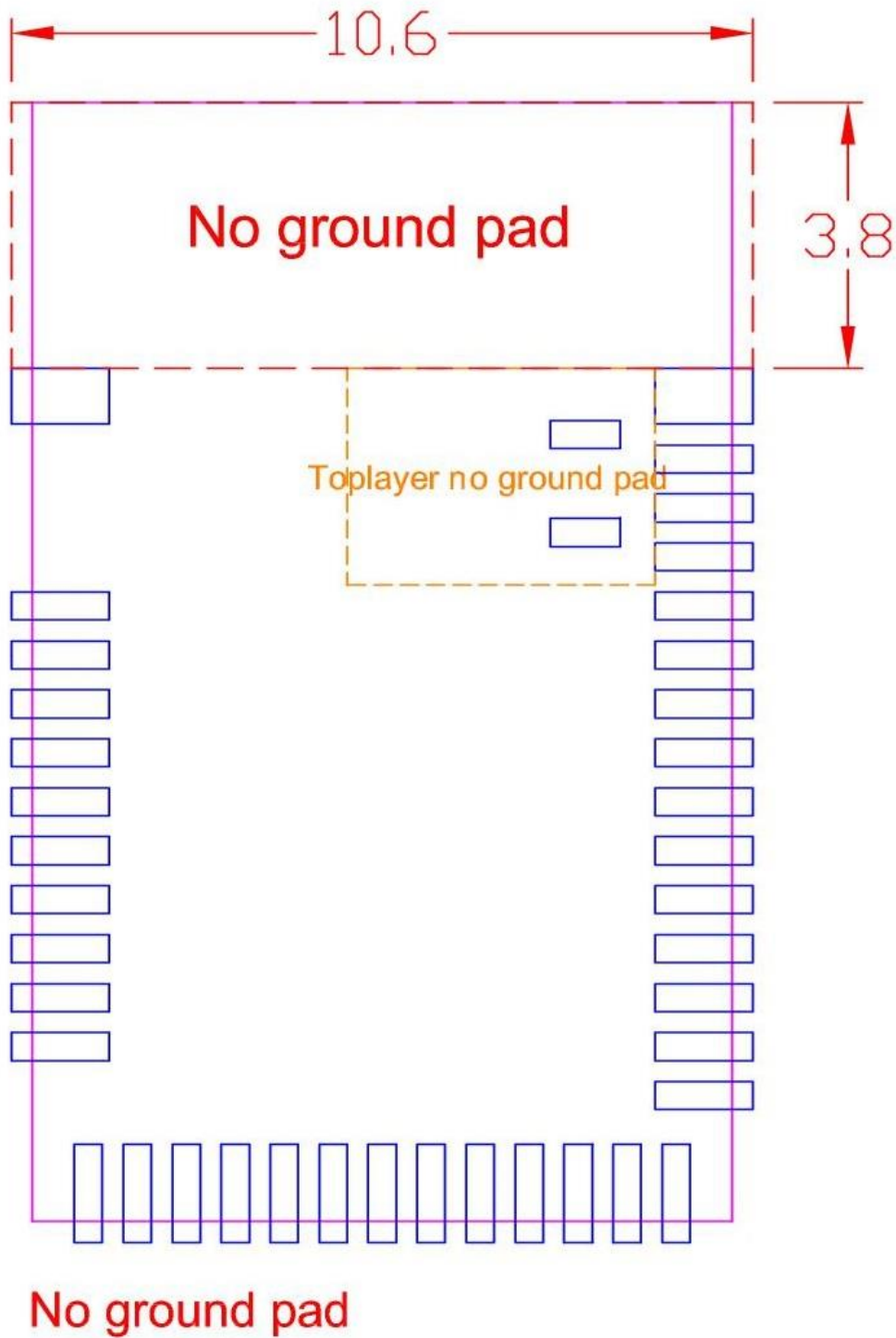

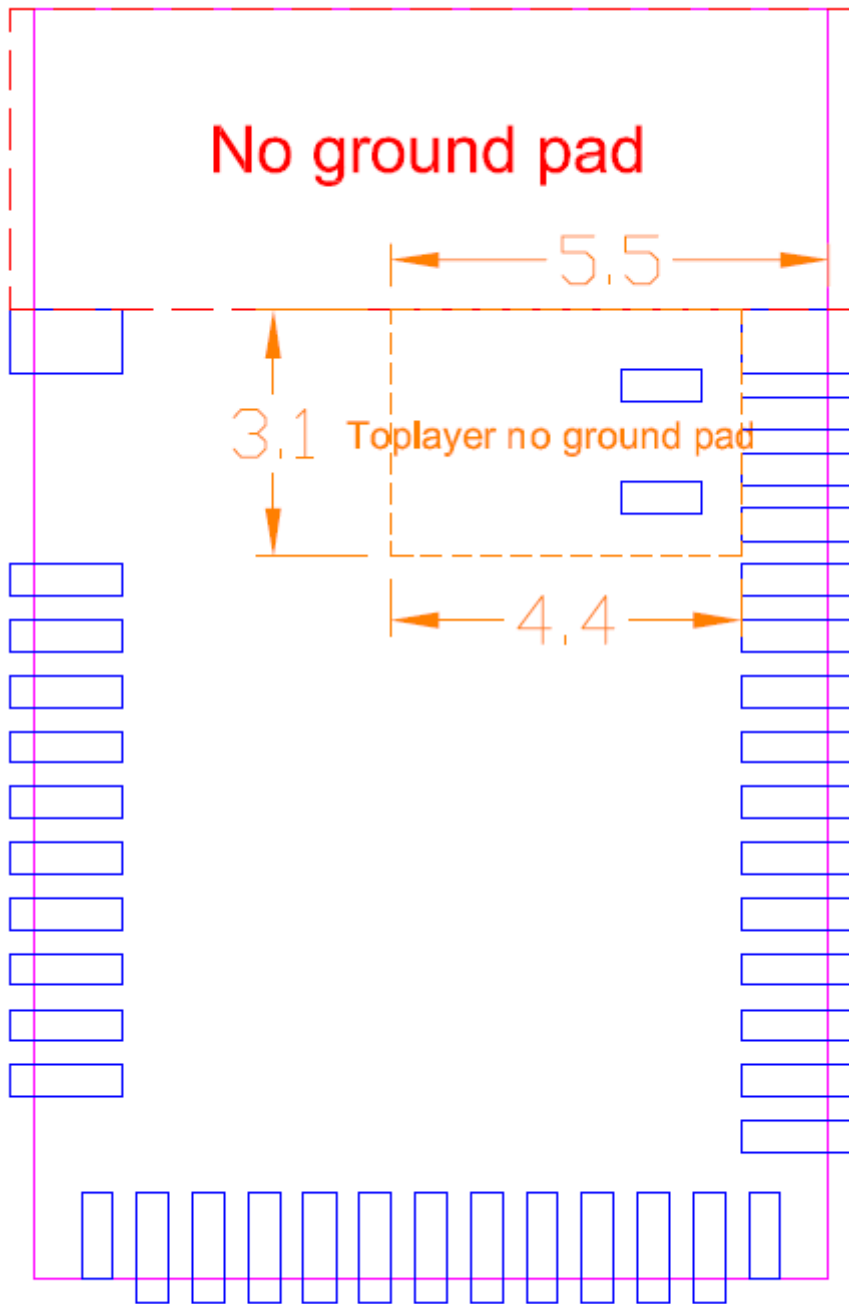

Toplayer no ground pad

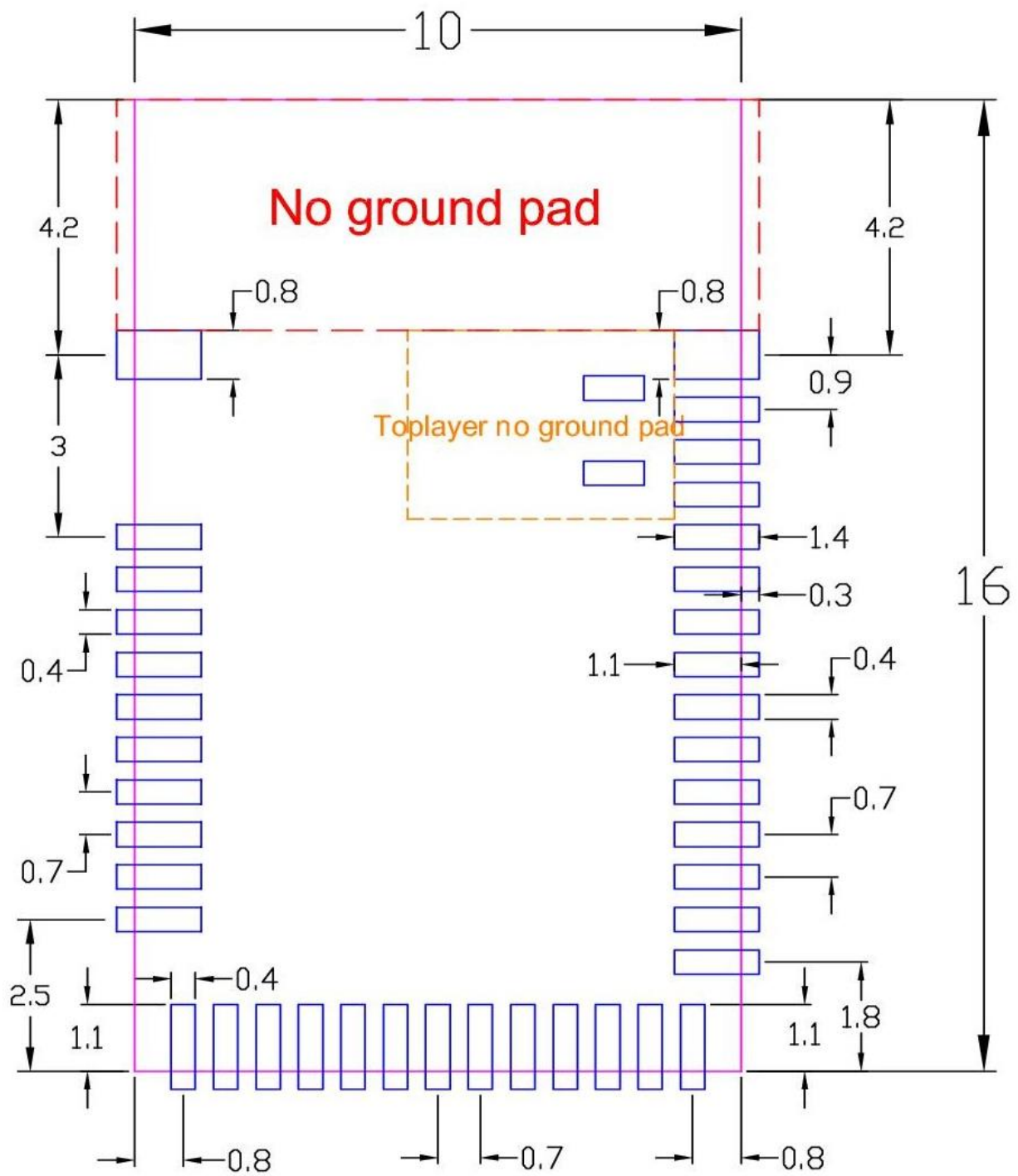

Top View (單位: mm)
recommended solder pad layout

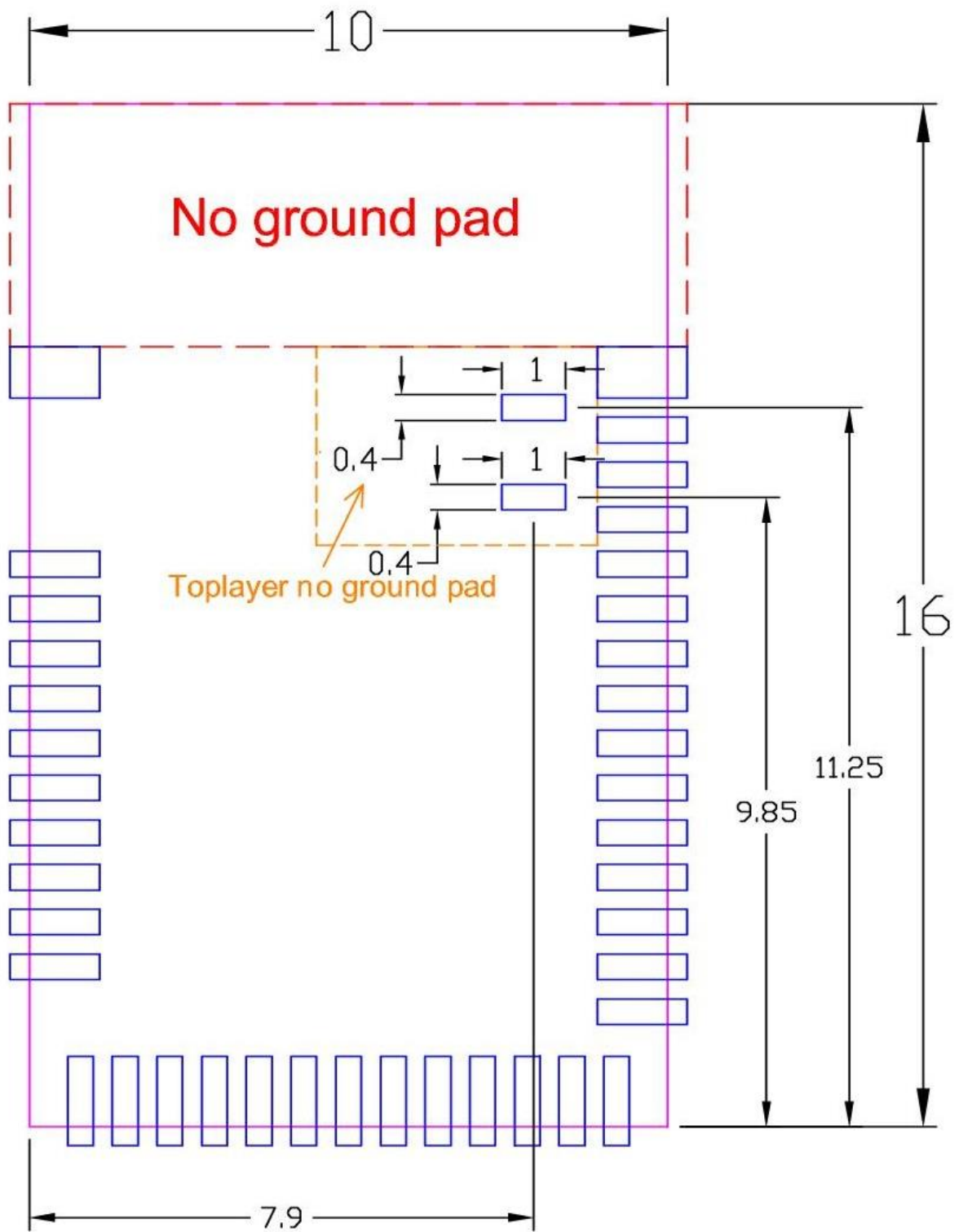

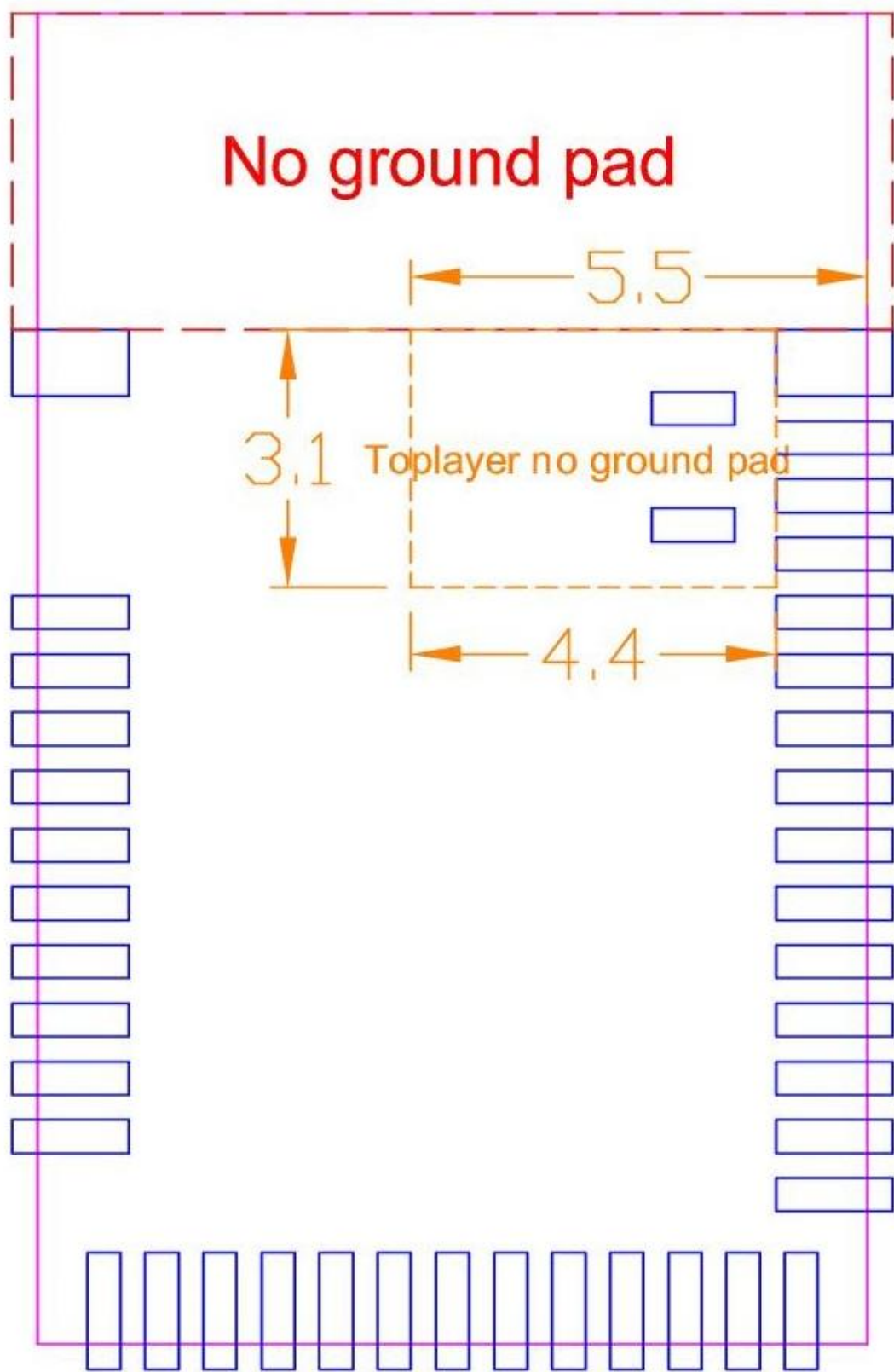

Toplayer no ground pad

2.3. RF Layout Suggestion (aka Keep-Out Area)

Please follow below instruction to have better wireless performance. Make sure to keep the “No-Ground-Pad” as wider as you can when there is no enough space in your design.

Welcome to send us your layout in PDF for review at service@raytac.com or your contact at Raytac with title “Layout reviewing – Raytac model no. – YOUR company’s name”.

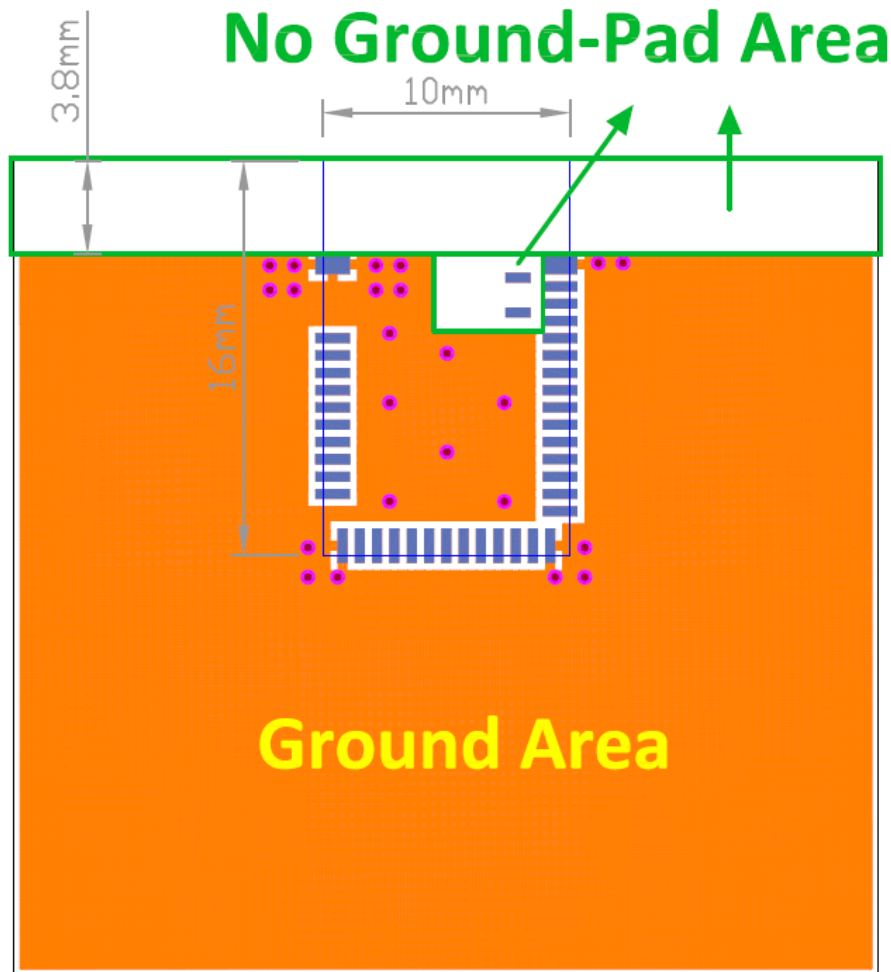

Top layer

Please add via holes in GROUND area as many as possible, especially around the four corners.

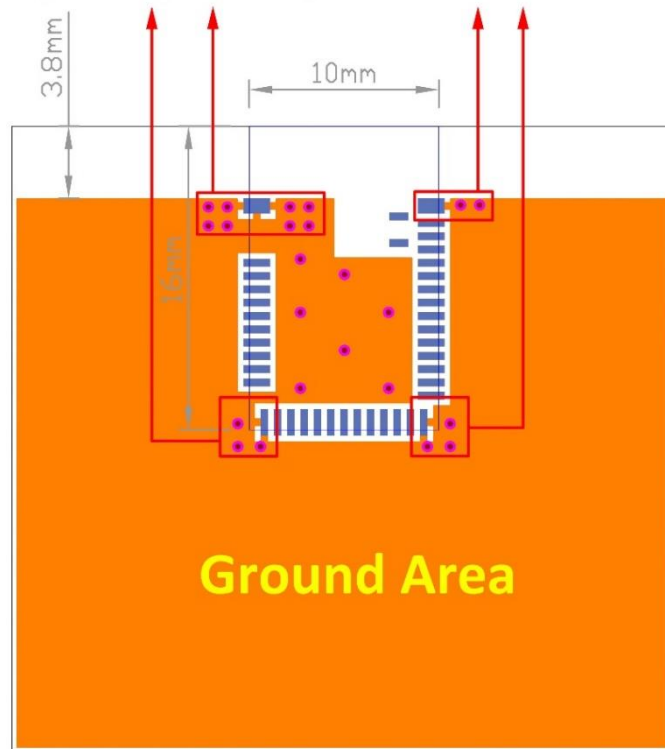

Top layer

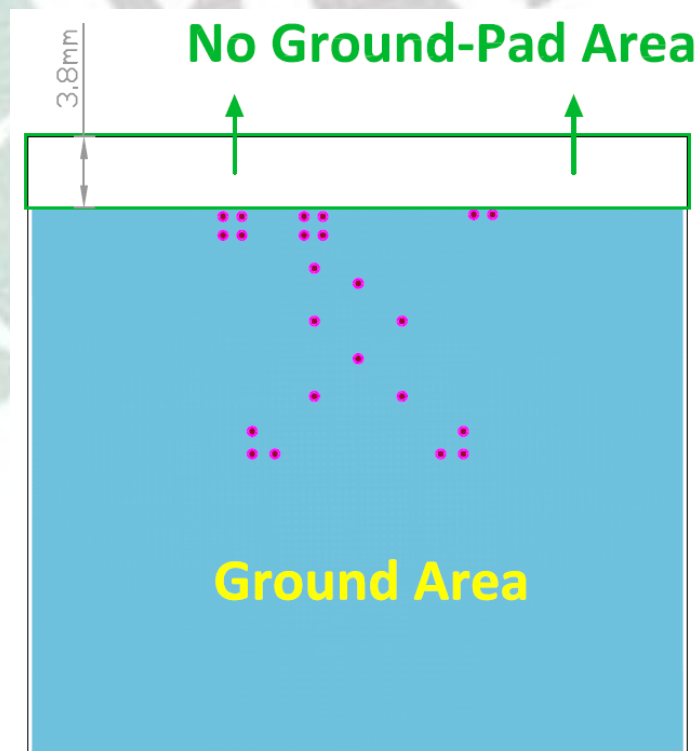

Bottom layer

Examples of “**NOT RECOMMENDED**” layout

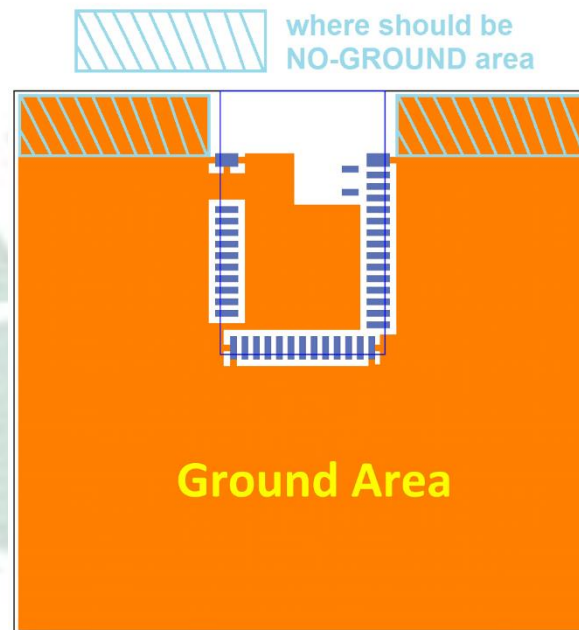
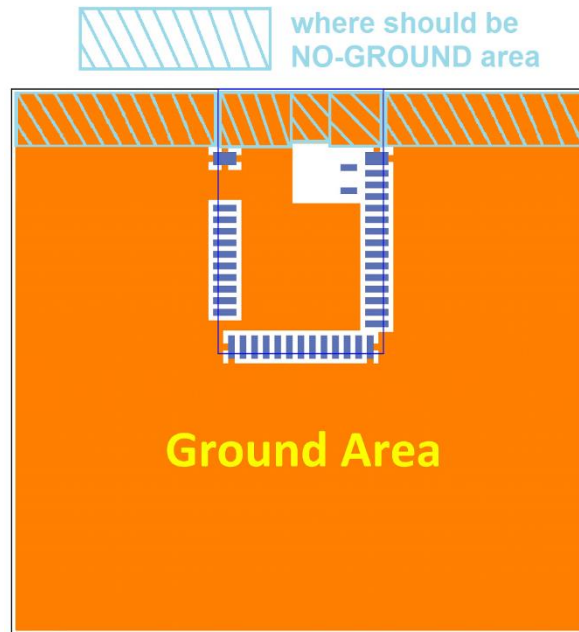

2.4. Footprint & Design Guide

Please visit “[Support](#)” page of our website to download. The package includes footprint, 2D/3D drawing, reflow graph and recommended spec for external 32.768khz.

2.5. Pin Assignment

Pin No.	Name	Pin function	Description
(1)	GND	Ground	The pad must be connected to a solid ground plane
(2)	P0.25	Digital I/O	General-purpose digital I/O
(3)	P0.26	Digital I/O	General-purpose digital I/O
(4)	P0.27	Digital I/O	General-purpose digital I/O
(5)	P0.28	Digital I/O	General-purpose digital I/O
	AIN4	Analog input	SAADC/COMP/LPCOMP input
(6)	P0.29	Digital I/O	General-purpose digital I/O
	AIN5	Analog input	SAADC/COMP/LPCOMP input
(7)	P0.30	Digital I/O	General-purpose digital I/O
	AIN6	Analog input	SAADC/COMP/LPCOMP input
(8)	P0.31	Digital I/O	General-purpose digital I/O
	AIN7	Analog input	SAADC/COMP/LPCOMP input
(9)	DEC4	Power	1V3 regulator supply decoupling. Input from DC/DC converter. Output from 1V3 LDO .
(10)	DCC	Power	DC/DC converter output pin
(11)	VDD	Power	Power-supply pin
(12)	GND	Ground	The pad must be connected to a solid ground plane
(13)	P0.00	Digital I/O	General-purpose digital I/O
	XL1	Analog input	Connection to 32.768khz crystal (LFXO)
(14)	P0.01	Digital I/O	General-purpose digital I/O
	XL2	Analog input	Connection to 32.768khz crystal (LFXO)
(15)	P0.02	Digital I/O	General-purpose digital I/O
	AIN0	Analog input	SAADC/COMP/LPCOMP input
(16)	P0.03	Digital I/O	General-purpose digital I/O
	AIN1	Analog input	SAADC/COMP/LPCOMP input
(17)	P0.04	Digital I/O	General-purpose digital I/O
	AIN2	Analog input	SAADC/COMP/LPCOMP input
(18)	P0.05	Digital I/O	General-purpose digital I/O
	AIN3	Analog input	SAADC/COMP/LPCOMP input
(19)	P0.06	Digital I/O	General-purpose digital I/O
(20)	P0.07	Digital I/O	General-purpose digital I/O
(21)	P0.08	Digital I/O	General-purpose digital I/O

Pin No.	Name	Pin function	Description
(22)	P0.09	Digital I/O	General-purpose digital I/O
	NFC1	NFC input	NFC antenna connection
(23)	P0.10	Digital I/O	General-purpose digital I/O
	NFC2	NFC input	NFC antenna connection
(24)	GND	Ground	The pad must be connected to a solid ground plane
(25)	P0.11	Digital I/O	General-purpose digital I/O
(26)	P0.12	Digital I/O	General-purpose digital I/O
(27)	P0.13	Digital I/O	General-purpose digital I/O
(28)	P0.14	Digital I/O	General-purpose digital I/O
	TraceData(3)		Trace port output
(29)	P0.15	Digital I/O	General-purpose digital I/O
	TraceData(2)		Trace port output
(30)	P0.16	Digital I/O	General-purpose digital I/O
	TraceData(1)		Trace port output
(31)	P0.17	Digital I/O	General-purpose digital I/O
(32)	P0.18	Digital I/O	General-purpose digital I/O
	TraceData(0)		Trace port output
(33)	P0.19	Digital I/O	General-purpose digital I/O
(34)	P0.20	Digital I/O	General-purpose digital I/O
	TraceCLK		Trace port clock output
(35)	P0.21	Digital I/O	General-purpose digital I/O
	RESET		Configurable as system RESET pin
(36)	SWDCLK	Digital input	Serial Wire debug clock input for debug and programming
(37)	SWDIO	Digital I/O	Serial Wire debug I/O for debug and programming
(38)	P0.22	Digital I/O	General-purpose digital I/O
(39)	GND	Ground	The pad must be connected to a solid ground plane
(40)	P0.24	Digital I/O	General-purpose digital I/O
(41)	P0.23	Digital I/O	General-purpose digital I/O

2.6. GPIO Located Near the Radio

Some GPIO have recommended usage. To maximize RF performance, these GPIO are only available to use as **low drive, low frequency I/O only**. Wrong usage may lead to undesirable performance. Here is the list of these GPIO:



Pin	GPIO	Recommended Usage
27	P0.22	Low drive, low frequency I/O only.
28	P0.23	
29	P0.24	
37	P0.25	
38	P0.26	
39	P0.27	
40	P0.28	
41	P0.29	
42	P0.30	

3. Main Chip Solution

RF IC	Crystal Frequency
Nordic NRF52832	32MHZ

32MHz crystal is already inside the module.

4. Shipment Packaging Information

Antenna	Model
Chip/Ceramic Antenna	MDBT42Q-512KV2
	
PCB/Printed Antenna	MDBT42Q-P512KV2
	

One yellow dot is for modules with revision 2 IC and with date code 813 and after.

- Unit Weight of Module:

MDBT42Q-512KV2: 0.64g / pc (± 0.02 g) ; MDBT42Q-P512KV2: 0.62g / pc (± 0.02 g)

- Packaging Type: Anti-static Tray or Tape & Reel.

	Tray	Tape & Reel
MPQ (Min. Package Q'ty)	88 pcs per tray	1,056 pcs per reel
Carton Contents (per carton)	1,760 pcs	1,056 pcs
Carton Dimension (L) x (W) x (H) cm	37 x 21 x 13	37 x 36 x 6
Gross Weight	about 2.8 kgs	about 1.5 kgs

4.1. Marking on Metal Shield

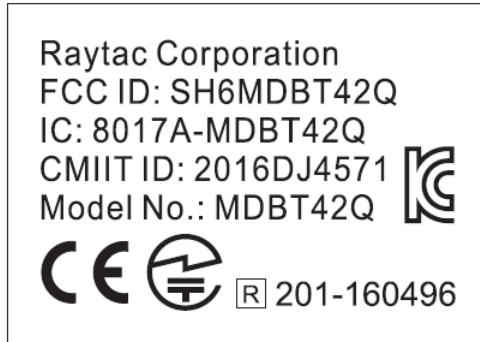

4.2. Packaging Info

4.2.1. Tray Packaging

Anti-static tray is specifically designed for mass production. It can be used directly on SMT automatic machine.

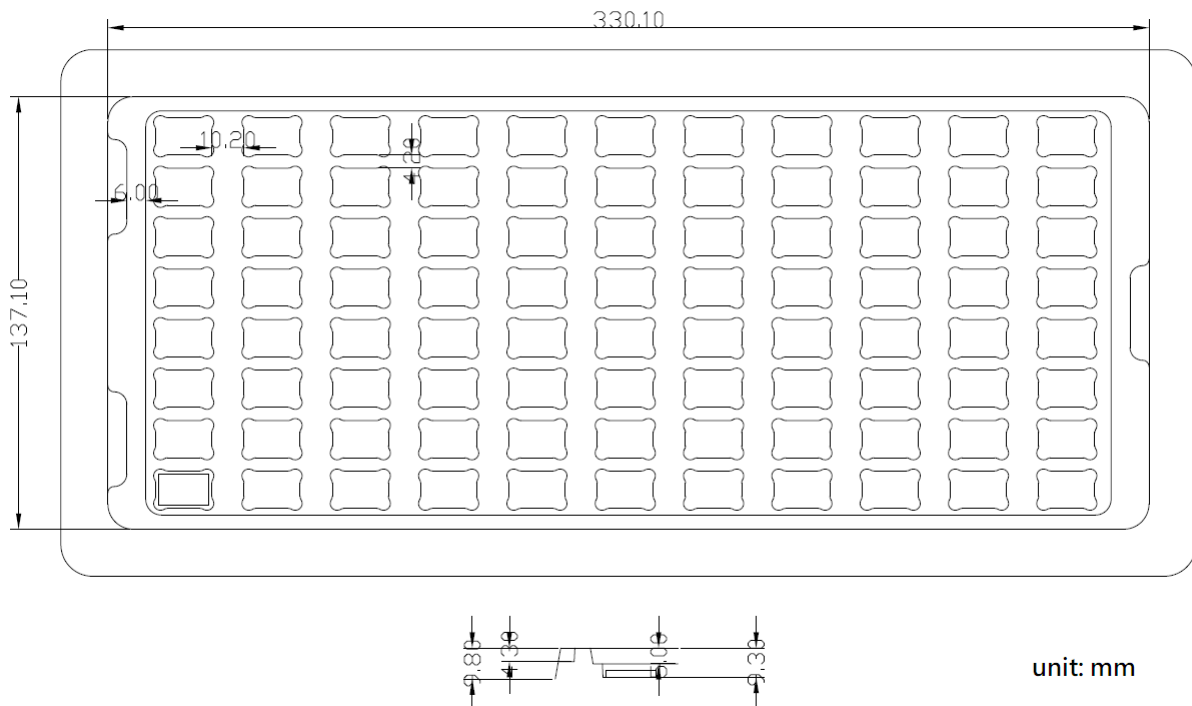

4.2.2. Reel Packaging

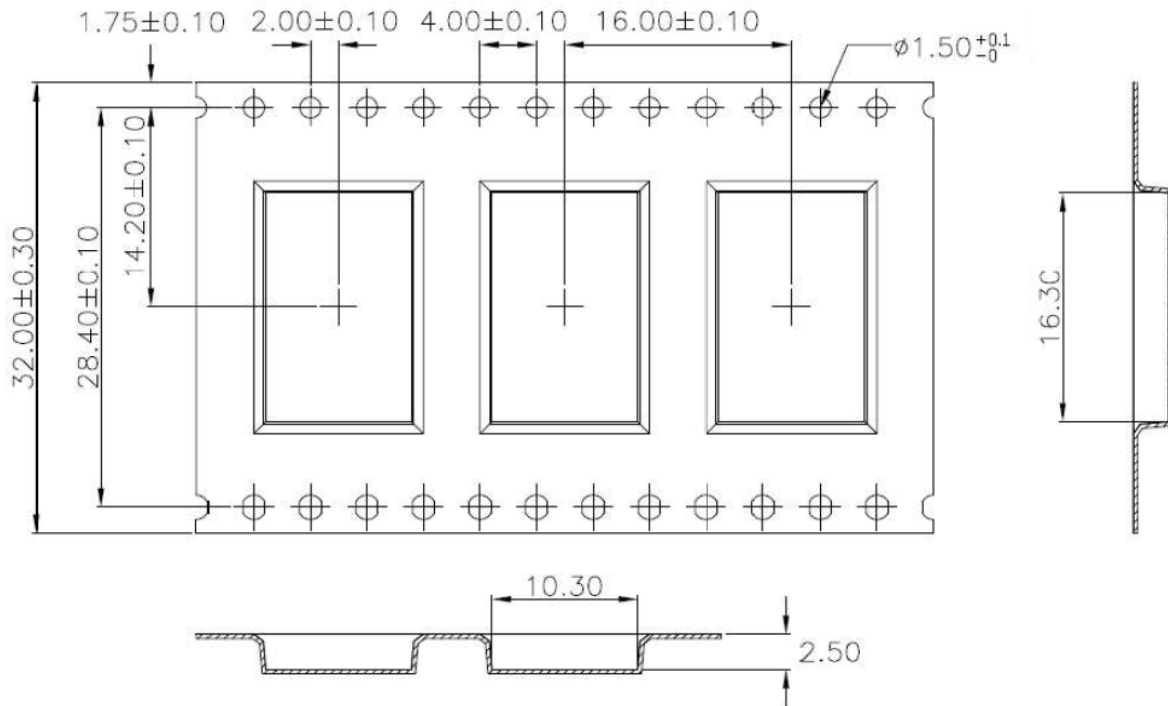

W	32.00	± 0.30
P1	16.00	± 0.10
E1	1.75	± 0.10
F	14.20	± 0.10
D0	1.50	$+0.1/-0$
P0	4.00	± 0.10
P2	2.00	± 0.10
S0	28.40	± 0.10
A0	10.30	± 0.10
B0	16.30	± 0.10
K0	2.50	± 0.10
T	0.30	± 0.05

4.3. Order Code

Each model has two options of packaging. Please use following part no. when placing order to us.

Note that MPQ of Reel packaging is 1,056 pcs and Tray packaging is 88 pcs.

<u>Tray</u> Packaging	MD-240A2-S19 → MDBT42Q-512KV2
	MD-240A2-S20 → MDBT42Q- P 512KV2
<u>Reel</u> Packaging	MD-240A2-S19R → MDBT42Q-512KV2
	MD-240A2-S20R → MDBT42Q- P 512KV2



5. Specification

Any technical spec shall refer to Nordic's official documents as final reference. Contents below are from "[nRF52832 Product Specification v1.4](#)", please click to download full spec.

5.1. Absolute Maximum Ratings

	Min.	Max.	Unit
Supply voltages			
VDD	-0.3	+3.9	V
VSS		0	V
I/O pin voltage			
$V_{I/O}, VDD \leq 3.6\text{ V}$	-0.3	$VDD + 0.3\text{ V}$	V
$V_{I/O}, VDD > 3.6\text{ V}$	-0.3	3.9 V	V
NFC antenna pin current			
$I_{NFC1/2}$		80	mA
Radio			
RF input level		10	dBm
Environmental QFN48, 6x6 mm package			
Storage temperature	-40	+125	°C
MSL (moisture sensitivity level)		2	
ESD HBM (human body model)		4	kV
ESD CDM (charged device model)		1000	V
Flash memory			
Endurance	10 000		Write/erase cycles
Retention	10 years at 40°C		

5.2. Operation Conditions

Symbol	Parameter	Min.	Nom.	Max.	Units
VDD	Supply voltage, independent of DCDC enable	1.7	3.0	3.6	V
t_{R_VDD}	Supply rise time (0 V to 1.7 V)			60	ms
TA	Operating temperature	-40	25	85	°C

Important: The on-chip power-on set circuitry may not function properly for rise times longer than the specified maximum.

5.3. Electrical Specifications

5.3.1. General Radio Characteristics

Symbol	Description	Min.	Typ.	Max.	Units
f_{OP}	Operating frequencies	2360		2500	MHz
$f_{PLL,PROG,RES}$	PLL programming resolution		2		kHz
$f_{PLL,CH,SP}$	PLL channel spacing		1		MHz
$f_{DELTA,1M}$	Frequency deviation @ 1 Msps		± 170		kHz
$f_{DELTA,BLE,1M}$	Frequency deviation @ BLE 1Msps		± 250		kHz
$f_{DELTA,2M}$	Frequency deviation @ 2 Msps		± 320		kHz
$f_{DELTA,BLE,2M}$	Frequency deviation @ BLE 2 Msps		± 500		kHz
f_{skSPS}	On-the-air data rate	1		2	Msps

5.3.2. Radio Current Consumption (Transmitter)

Symbol	Description	Min.	Typ.	Max.	Units
$I_{TX,PLUS4dBm,DCDC}$	TX only run current (DCDC, 3V) $P_{RF} = +4$ dBm		7.5		mA
$I_{TX,PLUS4dBm}$	TX only run current $P_{RF} = +4$ dBm		16.6		mA
$I_{TX,0dBm,DCDC}$	TX only run current (DCDC, 3V) $P_{RF} = 0$ dBm		5.3		mA
$I_{TX,0dBm}$	TX only run current $P_{RF} = 0$ dBm		11.6		mA
$I_{TX,MINUS4dBm,DCDC}$	TX only run current DCDC, 3V $P_{RF} = -4$ dBm		4.2		mA
$I_{TX,MINUS4dBm}$	TX only run current $P_{RF} = -4$ dBm		9.3		mA
$I_{TX,MINUS8dBm,DCDC}$	TX only run current DCDC, 3V $P_{RF} = -8$ dBm		3.8		mA
$I_{TX,MINUS8dBm}$	TX only run current $P_{RF} = -8$ dBm		8.4		mA
$I_{TX,MINUS12dBm,DCDC}$	TX only run current DCDC, 3V $P_{RF} = -12$ dBm		3.5		mA
$I_{TX,MINUS12dBm}$	TX only run current $P_{RF} = -12$ dBm		7.7		mA
$I_{TX,MINUS16dBm,DCDC}$	TX only run current DCDC, 3V $P_{RF} = -16$ dBm		3.3		mA
$I_{TX,MINUS16dBm}$	TX only run current $P_{RF} = -16$ dBm		7.3		mA
$I_{TX,MINUS20dBm,DCDC}$	TX only run current DCDC, 3V $P_{RF} = -20$ dBm		3.2		mA
$I_{TX,MINUS20dBm}$	TX only run current $P_{RF} = -20$ dBm		7.0		mA
$I_{TX,MINUS40dBm,DCDC}$	TX only run current DCDC, 3V $P_{RF} = -40$ dBm		2.7		mA
$I_{TX,MINUS40dBm}$	TX only run current $P_{RF} = -40$ dBm		5.9		mA
$I_{START,TX,DCDC}$	TX start-up current DCDC, 3V, $P_{RF} = 4$ dBm		4.0		mA
$I_{START,TX}$	TX start-up current, $P_{RF} = 4$ dBm		8.8		mA

5.3.3. Radio Current Consumption (Receiver)

Symbol	Description	Min.	Typ.	Max.	Units
$I_{RX,1M,DCDC}$	RX only run current (DCDC, 3V) 1Msps / 1Msps BLE		5.4		mA
$I_{RX,1M}$	RX only run current 1Msps / 1Msps BLE		11.7		mA
$I_{RX,2M,DCDC}$	RX only run current (DCDC, 3V) 2Msps / 2Msps BLE		5.8		mA
$I_{RX,2M}$	RX only run current 2Msps / 2Msps BLE		12.9		mA
$I_{START,RX,DCDC}$	RX start-up current (DCDC 3V)		3.5		mA
$I_{START,RX,LDO}$	RX start-up current (LDO 3V)		7.5		mA

5.3.4. Transmitter Specification

Symbol	Description	Min.	Typ.	Max.	Units
P_{RF}	Maximum output power		4	6	dBm
P_{RFC}	RF power control range		24		dB
P_{RFCR}	RF power accuracy			±4	dB
$P_{RF1,1}$	1st Adjacent Channel Transmit Power 1 MHz (1 Msps Nordic proprietary mode)		-25		dBc
$P_{RF2,1}$	2nd Adjacent Channel Transmit Power 2 MHz (1 Msps Nordic proprietary mode)		-50		dBc
$P_{RF1,2}$	1st Adjacent Channel Transmit Power 2 MHz (2 Msps Nordic proprietary mode)		-25		dBc
$P_{RF2,2}$	2nd Adjacent Channel Transmit Power 4 MHz (2 Msps Nordic proprietary mode)		-50		dBc
$P_{RF1,2,BLE}$	1st Adjacent Channel Transmit Power 2 MHz (2 Msps BLE mode)		-20		dBc
$P_{RF2,2,BLE}$	2nd Adjacent Channel Transmit Power 4 MHz (2 Msps BLE mode)		-50		dBc

5.3.5. Receiver Operation

Symbol	Description	Min.	Typ.	Max.	Units
$P_{RX,MAX}$	Maximum received signal strength at < 0.1% BER		0		dBm
$P_{SENS,IT,1M}$	Sensitivity, 1Msps nRF mode ¹		-93		dBm
$P_{SENS,IT,SP,1M,BLE}$	Sensitivity, 1Msps BLE ideal transmitter, <=37 bytes BER=1E-3 ²		-96		dBm
$P_{SENS,IT,LP,1M,BLE}$	Sensitivity, 1Msps BLE ideal transmitter >=128 bytes BER=1E-4 ³		-95		dBm
$P_{SENS,IT,2M}$	Sensitivity, 2Msps nRF mode ⁴		-89		dBm
$P_{SENS,IT,SP,2M,BLE}$	Sensitivity, 2Msps BLE ideal transmitter, Packet length <=37bytes		-93		dBm

1. Typical sensitivity applies when ADDR0 is used for receiver address correlation. When ADDR [1...7] are used for receiver address correlation, the typical sensitivity for this mode is degraded by 3dB.
2. As defined in the Bluetooth Core Specification v4.0 Volume 6: Core System Package (Low Energy Controller Volume).
3. Equivalent BER limit < 10E-04.
4. Same as remark 1.

Symbol	Description	Min.	Typ.	Max.	Units
P _{SENS,DT,SP,2M,BLE}	Sensitivity, 2Msps BLE dirty transmitter, Packet length <=37bytes		-93		dBm
P _{SENS,IT,LP,2M,BLE}	Sensitivity, 2Msps BLE ideal transmitter >= 128bytes		-92		dBm
P _{SENS,DT,LP,2M,BLE}	Sensitivity, 2Msps BLE dirty transmitter, Packet length >= 128bytes		-92		dBm

5.3.6. RX Selectivity

Symbol	Description	Min.	Typ.	Max.	Units
C/I _{1M,co-channel}	1Msps mode, Co-Channel interference		9		dB
C/I _{1M,-1MHz}	1 Msps mode, Adjacent (-1 MHz) interference		-2		dB
C/I _{1M,+1MHz}	1 Msps mode, Adjacent (+1 MHz) interference		-10		dB
C/I _{1M,-2MHz}	1 Msps mode, Adjacent (-2 MHz) interference		-19		dB
C/I _{1M,+2MHz}	1 Msps mode, Adjacent (+2 MHz) interference		-42		dB
C/I _{1M,-3MHz}	1 Msps mode, Adjacent (-3 MHz) interference		-38		dB
C/I _{1M,+3MHz}	1 Msps mode, Adjacent (+3 MHz) interference		-48		dB
C/I _{1M,±6MHz}	1 Msps mode, Adjacent (≥6 MHz) interference		-50		dB
C/I _{1MBLE,co-channel}	1 Msps BLE mode, Co-Channel interference		6		dB
C/I _{1MBLE,-1MHz}	1 Msps BLE mode, Adjacent (-1 MHz) interference		-2		dB
C/I _{1MBLE,+1MHz}	1 Msps BLE mode, Adjacent (+1 MHz) interference		-9		dB
C/I _{1MBLE,-2MHz}	1 Msps BLE mode, Adjacent (-2 MHz) interference		-22		dB
C/I _{1MBLE,+2MHz}	1 Msps BLE mode, Adjacent (+2 MHz) interference		-46		dB
C/I _{1MBLE,>3MHz}	1 Msps BLE mode, Adjacent (≥3 MHz) interference		-50		dB
C/I _{1MBLE,image}	Image frequency Interference		-22		dB
C/I _{1MBLE,image,1MHz}	Adjacent (1 MHz) interference to in-band image frequency		-35		dB
C/I _{2M,co-channel}	2Msps mode, Co-Channel interference		10		dB
C/I _{2M,-2MHz}	2 Msps mode, Adjacent (-2 MHz) interference		6		dB
C/I _{2M,+2MHz}	2 Msps mode, Adjacent (+2 MHz) interference		-14		dB
C/I _{2M,-4MHz}	2 Msps mode, Adjacent (-4 MHz) interference		-20		dB
C/I _{2M,+4MHz}	2 Msps mode, Adjacent (+4 MHz) interference		-44		dB
C/I _{2M,-6MHz}	2 Msps mode, Adjacent (-6 MHz) interference		-42		dB
C/I _{2M,+6MHz}	2 Msps mode, Adjacent (+6 MHz) interference		-47		dB
C/I _{2M,≥12MHz}	2 Msps mode, Adjacent (≥12 MHz) interference		-52		dB
C/I _{2MBLE,co-channel}	2 Msps BLE mode, Co-Channel interference		7		dB
C/I _{2MBLE,±2MHz}	2 Msps BLE mode, Adjacent (±2 MHz) interference		0		dB
C/I _{2MBLE,±4MHz}	2 Msps BLE mode, Adjacent (±4 MHz) interference		-47		dB
C/I _{2MBLE,≥6MHz}	2 Msps BLE mode, Adjacent (≥6 MHz) interference		-49		dB
C/I _{2MBLE,image}	Image frequency Interference		-21		dB
C/I _{2MBLE,image, 2MHz}	Adjacent (2 MHz) interference to in-band image frequency		-36		dB

Remark: Wanted signal level at PIN = -67 dBm. One interferer is used, having equal modulation as the wanted signal. The input power of the interferer where the sensitivity equals BER = 0.1% is presented.

5.3.7. RX Intermodulation

Symbol	Description	Min.	Typ.	Max.	Units
P _{IMD,1M}	IMD performance, 1 Msps (3 MHz, 4 MHz, and 5 MHz offset)		-33		dBm
P _{IMD,1M,BLE}	IMD performance, BLE 1 Msps (3 MHz, 4 MHz, and 5 MHz offset)		-30		dBm
P _{IMD,2M}	IMD performance, 2 Msps (6 MHz, 8 MHz, and 10 MHz offset)		-33		dBm
P _{IMD,2M,BLE}	IMD performance, BLE 2 Msps (6 MHz, 8 MHz, and 10 MHz offset)		-32		dBm

Remark: Wanted signal level at PIN = -64dBm. Two interferers with equal input power are used. The interferer closest in frequency is not modulated, the other interferer is modulated equal with the wanted signal. The input power of the interferers where the sensitivity equals BER = 0.1% is presented.

5.3.8. Radio Timing Parameters

Symbol	Description	Min.	Typ.	Max.	Units
t _{TXEN}	Time between TXEN task and READY event after channel FREQUENCY configured		140		us
t _{TXEN,FAST}	Time between TXEN task and READY event after channel FREQUENCY configured (Fast Mode)		40		us
t _{TXDISABLE}	Time between DISABLE task and DISABLED event when the radio was in TX and mode is set to 1Msps		6		us
t _{TXDISABLE,2M}	Time between DISABLE task and DISABLED event when the radio was in TX and mode is set to 2Msps		4		us
t _{RXEN}	Time between the RXEN task and READY event after channel FREQUENCY configured in default mode		140		us
t _{RXEN,FAST}	Time between the RXEN task and READY event after channel FREQUENCY configured in fast mode		40		us
t _{SWITCH}	The minimum time taken to switch from RX to TX or TX to RX (channel FREQUENCY unchanged)		20		us
t _{RXDISABLE}	Time between DISABLE task and DISABLED event when the radio was in RX		0		us
t _{TXCHAIN}	TX chain delay		0.6		us
t _{RXCHAIN}	RX chain delay		9.4		us
t _{RXCHAIN,2M}	RX chain delay in 2Msps mode		5		us

5.3.9. RSSI Specifications

Symbol	Description	Min.	Typ.	Max.	Units
RSSI _{ACC}	RSSI Accuracy Valid range -90 to -20 dBm		±2		dB
RSSI _{RESOLUTION}	RSSI resolution		1		dB
RSSI _{PERIOD}	Sample period		0.25		us

5.3.10. CPU

Symbol	Description	Min.	Typ.	Max.	Units
W_{FLASH}	CPU wait states, running from flash, cache disabled	0		2	
$W_{FLASHCACHE}$	CPU wait states, running from flash, cache enabled	0		3	
W_{RAM}	CPU wait states, running from RAM			0	
$I_{DDFLASHCACHE}$	CPU current, running from flash, cache enabled, LDO		7.4		mA
$I_{DDFLASHCACHEDCDC}$	CPU current, running from flash, cache enabled, DCDC 3V		3.7		mA
$I_{DDFLASH}$	CPU current, running from flash, cache disabled, LDO		8.0		mA
$I_{DDFLASHDCDC}$	CPU current, running from flash, cache disabled, DCDC 3V		3.9		mA
I_{DDRAM}	CPU current, running from RAM, LDO		6.7		mA
$I_{DDRAMDCDC}$	CPU current, running from RAM, DCDC 3V		3.3		mA
$I_{DDFLASH/MHz}$	CPU efficiency, running from flash, cache enabled, LDO		125		$\mu A /$ MHz
$I_{DDFLASHDCDC/MHz}$	CPU efficiency, running from flash, cache enabled, DCDC 3V		58		$\mu A /$ MHz
CM_{FLASH}	CoreMark ⁵ , running from flash, cache enabled		215		CoreM
$CM_{FLASH/MHz}$	CoreMark per MHz, running from flash, cache enabled		3.36		CoreM MHz
$CM_{FLASH/mA}$	CoreMark per mA, running from flash, cache enabled, DCDC 3V		58		CoreM mA

5.3.11. Power Management

Symbol	Description	Min.	Typ.	Max.	Units
$I_{ON_RAMOFF_EVENT}$	System ON, No RAM retention, Wake on any event		1.2		μA
$I_{ON_RAMON_EVENT}$	System ON, Full RAM retention, Wake on any event		1.5		μA
$I_{ON_RAMOFF_RTC}$	System ON, No RAM retention, Wake on RTC		1.9		μA
$I_{OFF_RAMOFF_RESET}$	System OFF, No RAM retention, Wake on reset		0.3		μA
$I_{OFF_RAMOFF_GPIO}$	System OFF, No RAM retention, Wake on GPIO		0.3		μA
$I_{OFF_RAMOFF_LPCOMP}$	System OFF, No RAM retention, Wake on LPCOMP		1.9		μA
$I_{OFF_RAMOFF_NFC}$	System OFF, No RAM retention, Wake on NFC field		0.7		μA
$I_{OFF_RAMON_RESET}$	System OFF, Full 64 kB RAM retention, Wake on reset		0.7		μA

6. Block Diagram

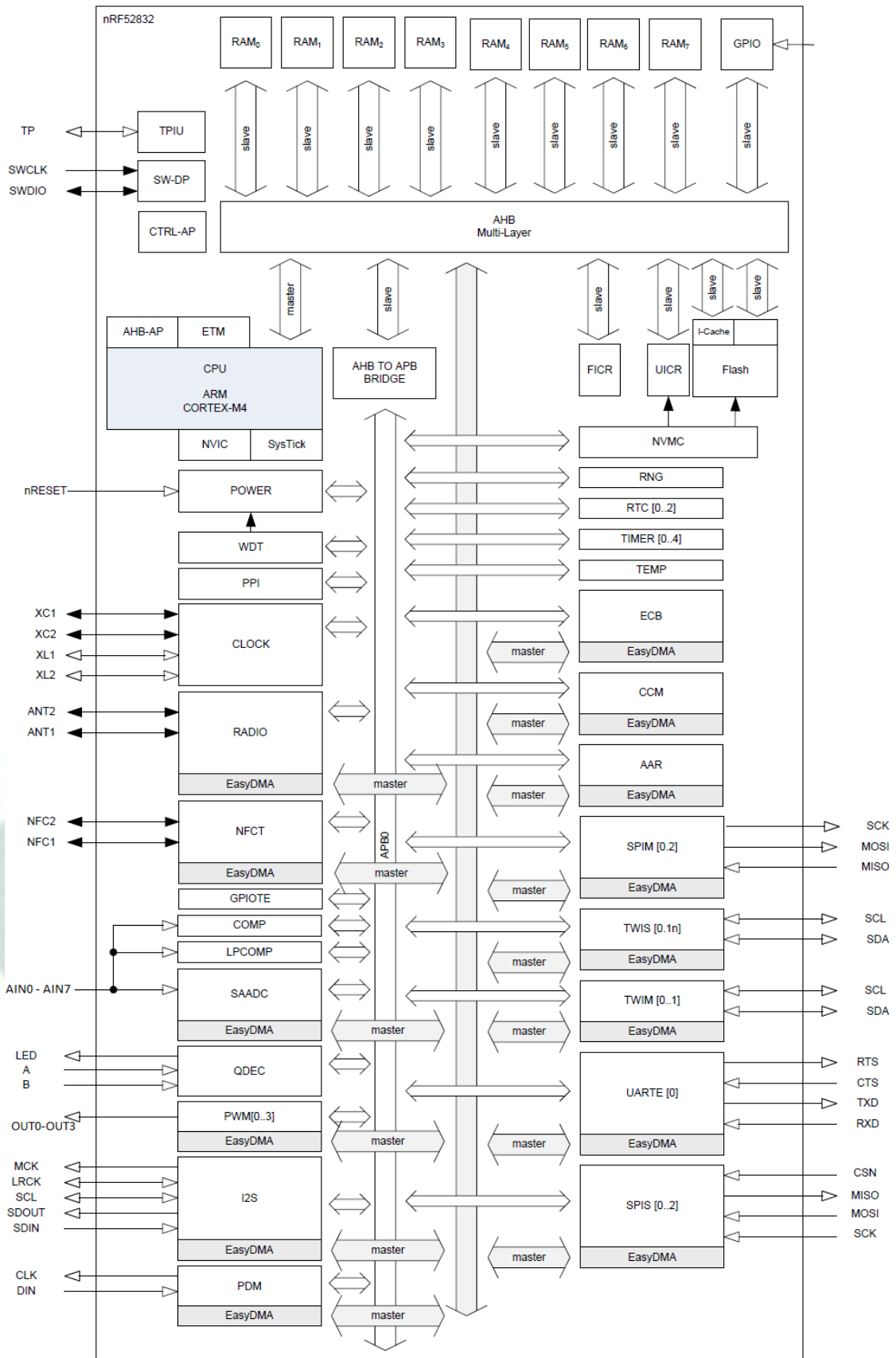

7. Antenna

7.1. MDBT42Q Series

Test Result

Frequency (MHz)	2400	2410	2420	2430	2440	2450	2460	2470	2480	2490	2500
Gain (dBi)	-3.68	-2.91	-2.34	-1.98	-1.66	-1.60	-1.77	-2.09	-2.60	-3.35	-4.10
Peak EIRP (dBm)	-3.68	-2.91	-2.34	-1.98	-1.66	-1.60	-1.77	-2.09	-2.60	-3.35	-4.10
Directivity (dBi)	4.98	5.11	5.12	5.02	4.93	4.76	4.58	4.38	4.11	3.77	3.42

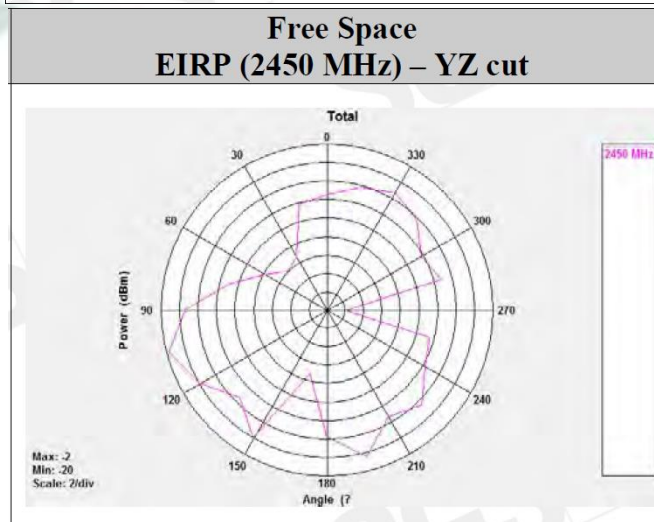
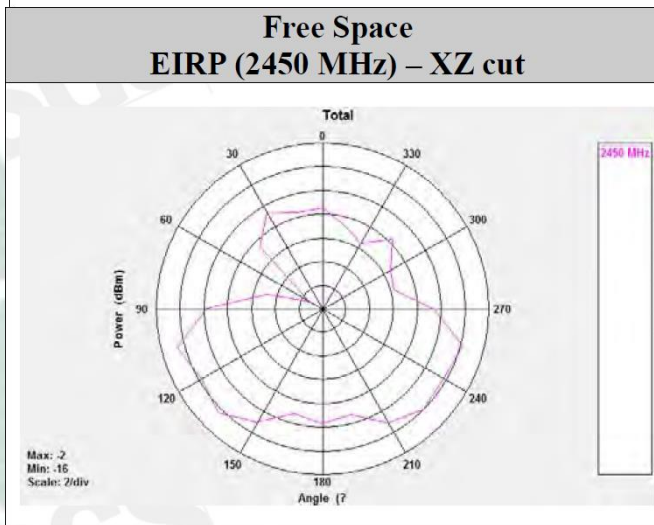
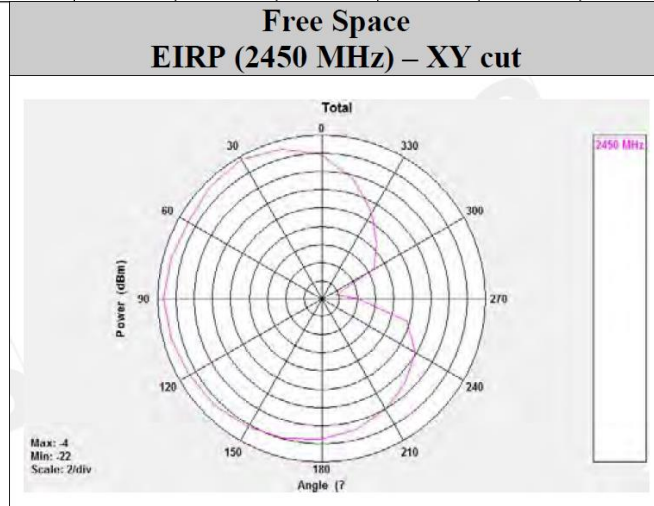

7.2. MDBT42Q-P Series

Test Result

Frequency (MHz)	2400	2410	2420	2430	2440	2450	2460	2470	2480	2490	2500
Gain (dBi)	-3.87	-3.06	-2.31	-2.01	-2.04	-2.31	-2.24	-1.96	-1.61	-1.71	-1.97
Peak EIRP (dBm)	-3.87	-3.06	-2.31	-2.01	-2.04	-2.31	-2.24	-1.96	-1.61	-1.71	-1.97
Directivity (dBi)	3.79	4.00	4.25	4.17	3.86	3.51	3.54	3.91	4.39	4.44	4.49

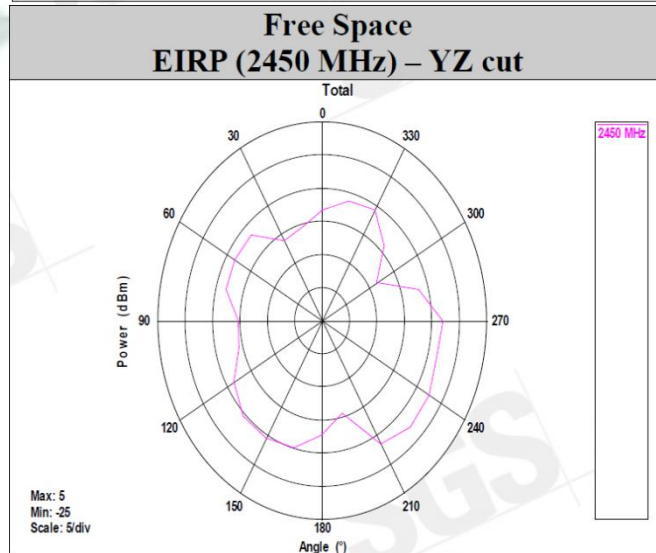
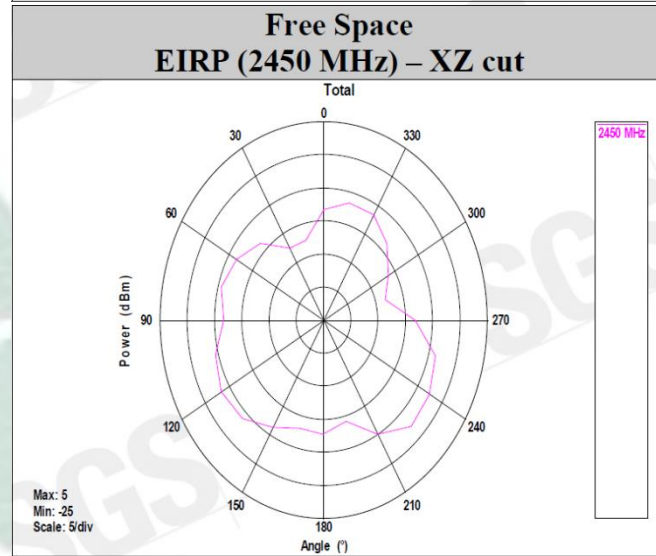
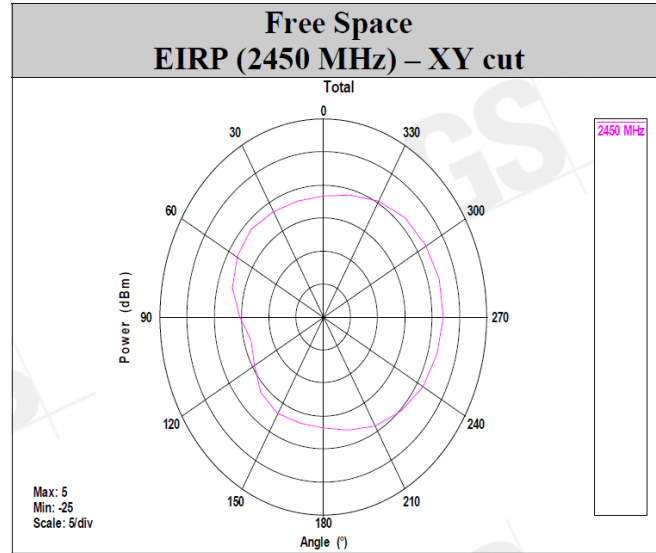

8. Reference Circuit

Module is pre-programmed with Raytac's testing code. Default is using "LDO mode". Our firmware is set to use external 32.768khz so please add it to make module work.

REMARK:

- ** DEC4 decoupling capacitor (1μF) is already inside the module. **
- ** When using DC-DC mode, please add L2 / L3 / C14. **
- ** When **NOT** using NFC, please remove NFC1 / C19 / C21. **
- ** When using internal 32.768khz RC oscillator, please remove X2 / C12 / C13. **

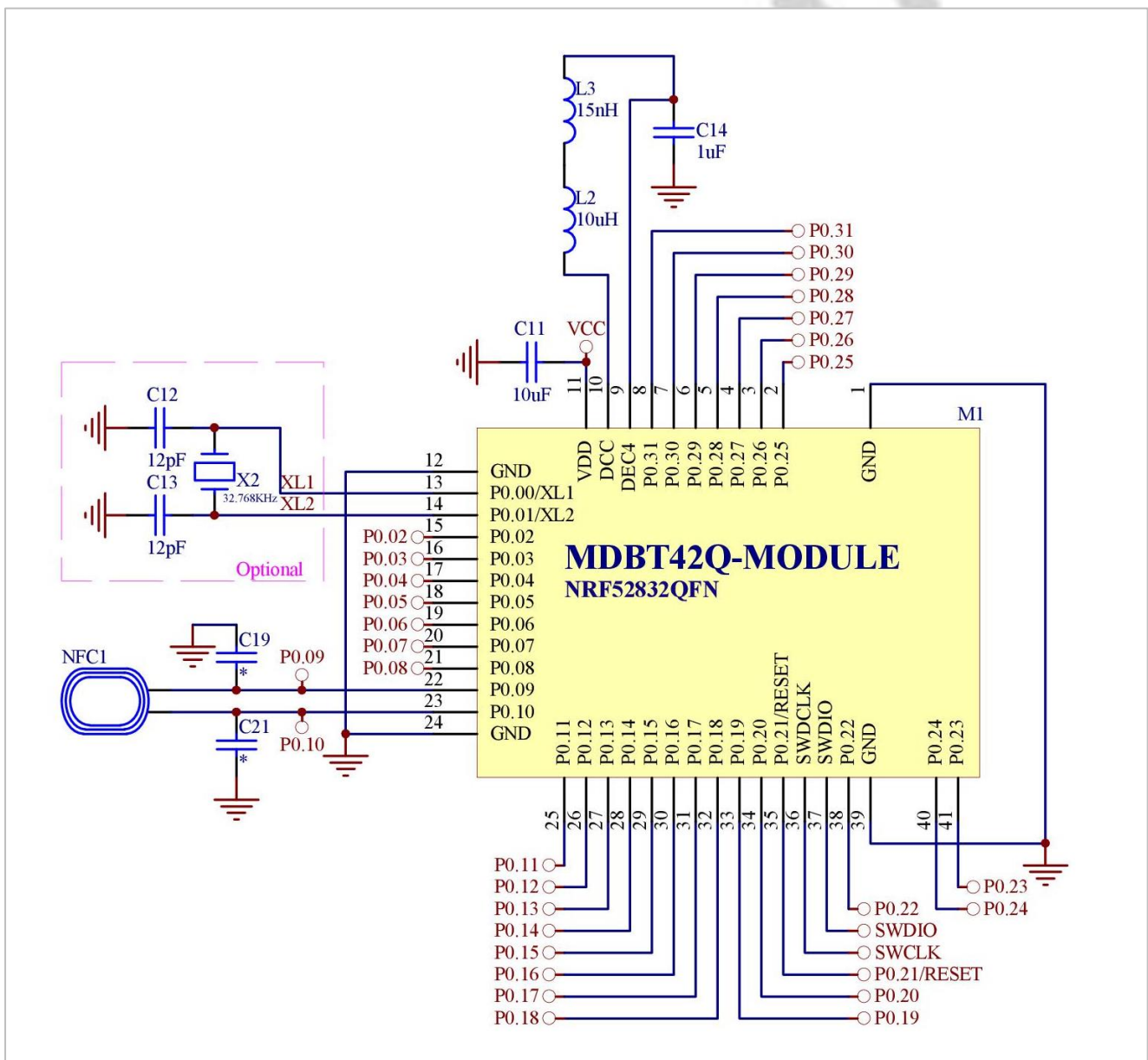

9. Certification

9.1. Declaration ID

QDL Bluetooth® qualified design listing

The Bluetooth SIG Hereby Recognizes

Raytac Corporation
Member Company

MDBT42 Series nRF52 Bluetooth Low Energy Module
Qualified Design Name

Declaration ID: D033661
Qualified Design ID: 91882
Specification Name: 4.2
Project Type: End Product
Model Number: MDBT42/MDBT42-P/MDBT42Q/MDBT42Q-P/MDBT42V/MDBT42V-P
Listing Date: 29 December 2016 Assessment Date: 29 December 2016
Hardware Version Number: V1 Software Version Number:

This certificate acknowledges the *Bluetooth*® Specifications declared by the member are achieved in accordance with the Bluetooth Qualification Process as specified within the Bluetooth Specifications and as required within the current PRD



QDL Bluetooth® qualified design listing

The Bluetooth SIG Hereby Recognizes

Raytac Corporation
Member Company

Multiprofile Subsystem for MDBTXX series module
Qualified Design Name

Declaration ID: D033622
Qualified Design ID: 91659
Specification Name: 4.2
Project Type: Profile Subsystem
Model Number: Multiprofile Subsystem for MDBTXX series module
Listing Date: 19 December 2016 Assessment Date: 19 December 2016
Hardware Version Number: NA Software Version Number: 1

This certificate acknowledges the *Bluetooth*® Specifications declared by the member are achieved in accordance with the Bluetooth Qualification Process as specified within the Bluetooth Specifications and as required within the current PRD



QDL Bluetooth® qualified design listing

The Bluetooth SIG Hereby Recognizes

Raytac Corporation

Member Company

nRF52xxx Bluetooth Module

Qualified Design Name

Declaration ID: D036781

Qualified Design ID: 100551

Specification Name: 5.0

Project Type: End Product

Model Number: MDBT42/MDBT42-P/MDBT42Q/MDBT42Q-P/MDBT42V/MDBT42V-P

Listing Date: 30 August 2017

Assessment Date: 30 August 2017

Hardware Version Number: 1

Software Version Number: 2

This certificate acknowledges the *Bluetooth*® Specifications declared by the member are achieved in accordance with the Bluetooth Qualification Process as specified within the Bluetooth Specifications and as required within the current PRD



9.2. FCC Certificate (USA)

BLE 4.2

telefication

TCB

**GRANT OF EQUIPMENT
AUTHORIZATION**

Certification
Issued Under the Authority of the
Federal Communications Commission
By:

TCB

Raytac Corp.
5F., No.3, Jiankang Rd., Zhonghe Dist.,
New Taipei City,, 23586
Taiwan

Attention: Venson Liao , R&D Manager

Telefication B.V.
Edisonstraat 12a
Zevenaar, NL-6902 PK
Netherlands

Date of Grant: 02/21/2017

Application
Dated: 02/21/2017

NOT TRANSFERABLE

EQUIPMENT AUTHORIZATION is hereby issued to the named
GRANTEE, and is VALID ONLY for the equipment identified hereon for
use under the Commission's Rules and Regulations listed below.

FCC IDENTIFIER:	SH6MDBT42Q		
Name of Grantee:	Raytac Corp.		
Equipment Class:	Digital Transmission System		
Notes:	BT 4.2 Module		
Modular Type:	Single Modular		

Grant Notes	FCC Rule Parts	Frequency Range (MHZ)	Output Watts	Frequency Emission Tolerance Designator
	15C	2402.0 - 2480.0	0.0023	

C2PC: To change module to be certified under portable device.
Power output listed is conducted. This grant is valid only when the module is sold to OEM integrators and must be installed by the OEM or OEM integrators. The antenna's as listed in this application must not be co-located or operating in conjunction with any other antenna or transmitter. End-users may not be provided with the module installation instructions. OEM integrators and end-users must be provided with transmitter operating conditions for satisfying RF exposure compliance.

<p>Certificate No.: 162181172/AA/01</p>	<p>Mohammad Elhaj Product Assessor</p>	
---	--	---

BLE 5.0



TCB

**GRANT OF EQUIPMENT
AUTHORIZATION**

TCB

Certification
Issued Under the Authority of the
Federal Communications Commission
By:

Telefication B.V.
Edisonstraat 12a
Zevenaar, NL-6902 PK
Netherlands

Date of Grant: 01/02/2018

Application
Dated: 12/18/2017

Raytac Corp.
5F., No.3, Jiankang Rd., Zhonghe Dist.,
New Taipei City., 23586
Taiwan

Attention: Venson Liao , R&D Manager

NOT TRANSFERABLE

EQUIPMENT AUTHORIZATION is hereby issued to the named
GRANTEE, and is VALID ONLY for the equipment identified hereon for
use under the Commission's Rules and Regulations listed below.

FCC IDENTIFIER: SH6MDBT42Q
Name of Grantee: Raytac Corp.
Equipment Class: Digital Transmission System
Notes: BLE Module
Modular Type: Single Modular

Grant Notes	FCC Rule Parts	Frequency Range (MHZ)	Output Watts	Frequency Emission Tolerance Designator
	15C	2402.0 - 2480.0	0.0023	

C2PC: add BT5.0 by Firmware and change product name to BLE module from BT 4.2 module. To change module to be certified under portable device.
Power output listed is conducted. This grant is valid only when the module is sold to OEM integrators and must be installed by the OEM or OEM integrators. The antenna's as listed in this application must not be co-located or operating in conjunction with any other antenna or transmitter. End-users may not be provided with the module installation instructions. OEM integrators and end-users must be provided with transmitter operating conditions for satisfying RF exposure compliance.

Certificate No.: 162181172/AA/02	George Lo Product Assessor	
-------------------------------------	-------------------------------	--

9.3. TELEC Certificate (Japan)

BLE 4.2

telefication bv
The Netherlands
Chamber of Commerce
51565536
www.telefication.com



telefication

Certificate
of
Radio Equipment in JAPAN

No: 201-160496 / 00

Telefication, operating as Conformity Assessment Body (CAB ID Number: 201) with respect to Japan, declares that the listed product complies with the Technical Regulations Conformity Certification of Terminal equipment (ordinance of MPT N° 31,1984)

Product description: **BT 4.2 Module**
Trademark: **Raytac**
Type designation: **MDBT42Q**
Hardware / Software version: **1 / 1**
Variants: **See Annex 3**

Manufacturer: **Raytac Corporation**
Address: **5F, No.3, Jiankang Rd., Zhonghe Dist.,**
City: **New Taipei 23586**
Country: **Taiwan**

This statement is granted to:

Name: **Raytac Corporation**
Address: **5F, No.3, Jiankang Rd., Zhonghe Dist.,**
City: **New Taipei 23586**
Country: **Taiwan**

This statement has THREE Annexes.

Zevenaar, 19 August 2016

CAB



Ramy Nabod
Product Assessor



PRODUCTS
RvA C 224

BLE 5.0

telefication by
The Netherlands
Chamber of Commerce
51565536
www.telefication.com



Certificate of Radio Equipment in JAPAN

No: 201-160496 / 02

Telefication, operating as Conformity Assessment Body (CAB ID Number: 201) with respect to Japan, declares that the listed product complies with the Technical Regulations Conformity Certification of Specified Radio equipment (ordinance of MPT N° 37,1981)

Product description: **BLE Module**
Trademark: **Raytac**
Type designation: **MDBT42Q**
Hardware / Software version: **1 / 1**
Variants: **See Annex 3**

Manufacturer: **Raytac Corporation**
Address: **5F, No. 3, Jiankang Rd., Zhonghe Dist.**
City: **23586 New Taipei City**
Country: **Taiwan**

This certificate is granted to:

Name: **Raytac Corporation**
Address: **5F, No. 3, Jiankang Rd., Zhonghe Dist.**
City: **23586 New Taipei City**
Country: **Taiwan**

This certificate has **THREE** Annexes.

Zevenaar, 23 May 2019

CAB

David Chen

David Chen
Product Assessor



9.4. NCC Certificate (Taiwan)

MDBT42Q Series

BLE 4.2

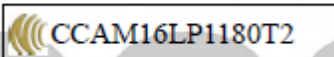
	台灣檢驗科技股份有限公司
低功率射頻電機型式認證證明	
一、申請者：	勁達國際電子有限公司
地址：	新北市中和區建康路3號5樓
二、製造廠商：	Ginstar Corporation
三、器材名稱：	BT 4.2 Module
四、廠牌：	Raytac
五、型號：	MDBT42Q
六、發射功率：	BT V4.2 single mode LE (GFSK): 3.57dBm (Peak)
七、工作頻率：	2402-2480MHz
八、審驗日期：	105年08月19日
九、審驗合格標籤式樣：	
說明：	
1. 請依上列標籤式樣自製標籤，標貼或印鑄於器材本體明顯處，始得販賣或公開陳列。	
2. 經型式認證合格之低功率射頻電機，其廠牌、型號、設計、射頻性能如有變更，應重新申請型式認證。	
3. 違反低功率電波輻射性電機管理辦法之規定，擅自使用或變更無線電頻率、電功率者，除依電信法規定處罰外，驗證機關(構)並得廢止其型式認證證明或型式認證標籤。	
4. 送審廠商應保留送審樣品供日後核對。	
5. 本型式認證證明及其合格標籤使用權專屬取得本證明者。依電信管制射頻器材審驗辦法第15條規定，持有人得經由網際網路申請同意他人於同廠牌同型號之電信管制射頻器材使用型式認證標籤，並於次日起30天內，應檢具「電信管制射頻器材審驗合格標籤，或符合性聲明標籤同意使用備查表」送國家通訊傳播委員會備查。	
備註：	
1. 本器材符合低功率射頻電機技術規範(3.10.1)之規定。	
2. 本公司僅對無線射頻特性技術規範辦理型式認證，其他仍須依本國相關法規辦理。	
3. 本器材使用天線型態: Chip Antenna，天線廠牌: Raytac，型號: MDBT42Q，增益: -1.6dBi。	
4. 本案審驗模組為完全模組，適用於任何平台。【平台】定義如下:若器材部組裝本案審驗模組，消費者仍能正常使用該器材主要功能，該器材得視為平台。若器材不組裝本案審驗模組，消費者不能正常使用該器材主要功能，該器材不能視為平台，該類不同廠牌型號器材組裝本案審驗模組後，須分別申請型式認證。	
5. 本公司係經國家通訊傳播委員會委託之驗證機構，核發本型式認證證明。	

台灣檢驗
科技股份
有限公司
電信設備
審驗印章

MDBT42Q-P Series

BLE 4.2

SGS

台灣檢驗科技股份有限公司

低功率射頻電機型式認證證明

- 一、申請者：勁達國際電子有限公司
地址：新北市中和區建康路3號5樓
- 二、製造廠商：Ginstar Corporation
- 三、器材名稱：BT 4.2 Module
- 四、廠牌：Raytac
- 五、型號：MDBT42Q-P
- 六、發射功率：BT V4.2 single mode LE (GFSK): 3.57dBm (Peak)
- 七、工作頻率：2402-2480MHz
- 八、審驗日期：105年08月19日
- 九、審驗合格標籤式樣：



說明：

- 請依上列標籤式樣自製標籤，標貼或印鑄於器材本體明顯處，始得販賣或公開陳列。
- 經型式認證合格之低功率射頻電機，其廠牌、型號、設計、射頻性能如有變更，應重新申請型式認證。
- 違反低功率電波輻射性電機管理辦法之規定，擅自使用或變更無線電頻率、電功率者，除依電信法規定處罰外，驗證機關(構)並得廢止其型式認證證明或型式認證標籤。
- 送審廠商應保留送審樣品供日後核對。
- 本型式認證證明及其合格標籤使用權專屬取得本證明者，依電信管制射頻器材審驗辦法第15條規定，持有人得經由網際網路申請同意他人於同廠牌同型號之電信管制射頻器材使用型式認證標籤，並於次日起30天內，應檢具「電信管制射頻器材審驗合格標籤，或符合性聲明標籤同意使用備查表」送國家通訊傳播委員會備查。

備註：

- 本器材符合低功率射頻電機技術規範(3.10.1)之規定。
- 本公司僅對無線射頻特性技術規範辦理型式認證，其他仍須依本國相關法規辦理。
- 本器材使用天線型態: PCB Antenna，天線廠牌: Raytac，型號: MDBT42Q-P，增益: -1.61dBi。
- 本案審驗模組為完全模組，適用於任何平台。【平台】定義如下:若器材部組裝本案審驗模組，消費者仍能正常使用該器材主要功能，該器材得視為平台。若器材不組裝本案審驗模組，消費者不能正常使用該器材主要功能，該器材不能視為平台，該類不同廠牌型號器材組裝本案審驗模組後，須分別申請型式認證。
- 本公司係經國家通訊傳播委員會委託之驗證機構，核發本型式認證證明。

9.5. CE Test Report (EU)

BLE 4.2 & 5.0

SGS

SGS Reference No: MH/2019/40103C

VERIFICATION OF EMC COMPLIANCE

Verification No. : MH/2019/40103C
Representative Model No. : MDBT42Q
Added Model(s) : MDBT42Q-P, MDBT42Q-U
Product Name : BLE Module
Brand Name : Raytac
Applicant : Raytac Corporation
Address of Applicant : 5F, No.3, Jiankang Rd., Zhonghe Dist., New Taipei City, 23586, Taiwan
Test Report Number : MH/2019/40103
Date of Issue : May 13, 2019
Applicable Standards : EN 301 489 –1 v2.2.0 : 2017-03 (Draft)
EN 301 489 –17 v3.2.0 : 2017-03 (Draft)
EN 55032 : 2015+AC:2016-07
EN 61000-4-2 : 2009, EN 61000-4-3 : 2006+A1:2008+A2:2010

Conclusion
The apparatus meets the requirements of the above standards and hence compliance the essential requirements under article 3.1b of the RED (2014/53/EU) Directive.

*This verification is only valid for the equipment and configuration described, and in conjunction with the test report as detailed above.

Authorized Signatory:
Eddy Cheng

SGS TAIWAN LTD.
Eddy Cheng
Technical Asst. Supervisor

VERIFICATION OF COMPLIANCE

Applicant: Raytac Corporation
5F, No.3, Jiankang Rd., Zhonghe Dist., New Taipei City , 23586,
Taiwan

Product Name: BLE Module

Brand Name: Raytac

Model No.: MDBT42Q, MDBT42Q-P

Model Difference: MDBT42Q with Chip antenna, MDBT42Q-P with PCB antenna

File Number: ER/2017/70008-01

Date of test: Nov. 09, 2017~ Nov. 28, 2017

Date of EUT Received: Nov. 09, 2017

APPLICABLE STANDARDS	
STANDARD	TEST RESULT
ETSI EN 300 328 v2.1.1: 2016	Complied

The above equipment was tested by SGS Taiwan Ltd., Electronics & Communication Laboratory for compliance with the requirements set forth in the European Standard ETSI EN 300 328 v2.1.1: 2016 under RED 2014/53/EU Class II. The results of testing in this report apply to the product system that was tested only. Other similar equipment will not necessarily produce the same results due to production tolerance and measurement uncertainties.

Test By:

Marcus Tseng

Date:

Dec. 05, 2017

Marcus Tsen / Engineer

Prepared By:

Yuri Tsai

Date:

Dec. 05, 2017

Yuri Tsai / Clerk

Approved By:

Jim Chang

Date:

Dec. 05, 2017

Jim Chang / Asst. Manager

9.6. IC Certificate (Canada)

BLE 4.2

<p>telefication bv The Netherlands Chamber of Commerce 51565536 www.telefication.com</p>			
<p>TECHNICAL ACCEPTANCE CERTIFICATE</p>		<p>CERTIFICAT D'ACCEPTABILITÉ TECHNIQUE</p>	
CERTIFICATION No. No. DE CERTIFICATION	8017A-MDBT42Q		
TELEFICATION No. No. DE TELEFICATION	162170280/AA/01		
TEST SITE No. No. DE LABORATOIRE	4620A-5		
ISSUED TO DÉLIVRÉ A	Raytac Corporation		
TYPE OF EQUIPMENT GENRE DE MATÉRIEL	Bluetooth device		
TRADE NAME AND MODEL MARQUE ET MODELE	Raytac / MDBT42Q Raytac / MDBT42Q-P		
CERTIFIED TO CERTIFIÉ SELON LE	SPECIFICATION CAHIER DES CHARGES	RSS-102 RSS-247	ISSUE EDITION 5 1
<p>Certification of equipment means only that the equipment has met the requirements of the above-noted specification. Licence applications, where applicable to use certified equipment, are acted on accordingly by the Industry Canada issuing office and will depend on the existing radio environment, service and location of operation. This certificate is issued on condition that the holder complies and will continue to comply with the requirements and procedures issued by Industry Canada. The equipment for which this certificate is issued shall not be manufactured, imported, distributed, leased, offered for sale or sold unless the equipment complies with the applicable technical specifications and procedures issued by Industry Canada.</p>		<p>La certification du matériel signifie seulement que le matériel a satisfait aux exigences de la norme indiquée ci-dessus. Les demandes de licences nécessaires pour l'utilisation du matériel certifié sont traitées en conséquence par le bureau de délivrance d'Industrie Canada et dépendent des conditions radio ambiantes, du service et de l'emplacement d'exploitation. Le présent certificat est délivré à la condition que le titulaire satisfasse et continue de satisfaire aux exigences et aux procédures d'Industrie Canada. Le matériel à l'égard duquel le présent certificat est délivré ne doit pas être fabriqué, importé, distribué, loué, mis en vente ou vendu à moins d'être conforme aux procédures et aux spécifications techniques applicables publiées par Industrie Canada.</p>	
<p>ISSUED BY TELEFICATION BV, RECOGNIZED CERTIFICATION BODY BY INDUSTRY CANADA DÉLIVRÉ PAR TELEFICATION BV, ORGANISME DE CERTIFICATION RECONNU PAR INDUSTRIE CANADA</p>			
<p><i>I hereby attest that the subject equipment was tested and found in compliance with the above-noted specification. J'atteste, par la présente, que le matériel a fait l'objet d'essai et a été jugé conforme à la spécification ci-dessus</i></p>			
DATE 21 Feb 2017 BY	Mohammad Elhaj Product Assessor		
<p>This certificate has one annex.</p>			

BLE 5.0

telefication bv
The Netherlands
Chamber of Commerce
51565536
www.telefication.com



TECHNICAL ACCEPTANCE CERTIFICATE

CERTIFICAT D'ACCEPTABILITÉ TECHNIQUE

CERTIFICATION No.
No. DE CERTIFICATION 8017A-MDBT42Q

TELEFICATION No.
No. DE TELEFICATION 162170280/AA/02

TEST SITE No.
No. DE LABORATOIRE 4620A-5

ISSUED TO
DELIVRE A Raytac Corporation

TYPE OF EQUIPMENT
GENRE DE MATÉRIEL Bluetooth device

TRADE NAME AND MODEL
MARQUE ET MODELE Raytac / MDBT42Q
Raytac / MDBT42Q-P

CERTIFIED TO CERTIFIÉ SELON LE	SPECIFICATION CAHIER DES CHARGES	RSS-102 RSS-247	ISSUE EDITION	5 2
-----------------------------------	-------------------------------------	--------------------	------------------	--------

Certification of equipment means only that the equipment has met the requirements of the above-noted specification. Licence applications, where applicable to use certified equipment, are acted on accordingly by the ISED issuing office and will depend on the existing radio environment, service and location of operation. This certificate is issued on condition that the holder complies and will continue to comply with the requirements and procedures issued by ISED. The equipment for which this certificate is issued shall not be manufactured, imported, distributed, leased, offered for sale or sold unless the equipment complies with the applicable technical specifications and procedures issued by ISED.

La certification du matériel signifie seulement que le matériel a satisfait aux exigences de la norme indiquée ci-dessus. Les demandes de licences nécessaires pour l'utilisation du matériel certifié sont traitées en conséquence par le bureau de délivrance d'ISDE et dépendent des conditions radio ambiantes, du service et de l'emplacement d'exploitation. Le présent certificat est délivré à la condition que le titulaire satisfasse et continue de satisfaire aux exigences et aux procédures d'ISDE. Le matériel à l'égard duquel le présent certificat est délivré ne doit pas être fabriqué, importé, distribué, loué, mis en vente ou vendu à moins d'être conforme aux procédures et aux spécifications techniques applicables publiées par ISDE.

ISSUED BY TELEFICATION BV (NL0001), RECOGNIZED CERTIFICATION BODY BY INNOVATION, SCIENCE AND ECONOMIC DEVELOPMENT CANADA
DELIVRE PAR TELEFICATION BV (NL0001), ORGANISME DE CERTIFICATION RECONNU PAR INNOVATION, SCIENCES ET DÉVELOPPEMENT ÉCONOMIQUE CANADA

*I hereby attest that the subject equipment was tested and found in compliance with the above-noted specification.
J'atteste, par la présente, que le matériel a fait l'objet d'essai et a été jugé conforme à la spécification ci-dessus*

DATE 02 Jan 2018 BY

George Lo
Product Assessor

This certificate has one annex.



9.7. SRRC Certificate (China)

BLE 4.2 & 5.0

无线电发射设备
Radio Transmission Equipment
型号核准证
Type Approval Certificate

劲达国际电子有限公司（台湾）：
根据《中华人民共和国无线电管理条例》，经审查，下列无线电发射设备
In accordance with the provisions on the Radio Regulations of the People's Republic of China, the following
符合中华人民共和国无线电管理规定和
radio transmission equipment, after examination, conforms
技术标准，其核准代码为：CMIIT ID: 2016DJ4571
to the provisions with its CMIIT ID:

有效期：五年
Validity

(发证机关)
Sealed by Issuing Authority

2016 年 8 月 12 日
Year Month Date

9.8. KC Certificate (South Korea)

BLE 4.2 & 5.0

B58D-F9CB-417D-C63A

방송통신기자재등의 적합인증서 <i>Certificate of Broadcasting and Communication Equipments</i>	
상호 또는 성명 <i>Trade Name or Applicant</i>	Raytac Corporation
기자재명칭(명칭) <i>Equipment Name</i>	특정소출력 무선기기(무선데이터통신시스템용 무선기기)
기본모델명 <i>Basic Model Number</i>	MDBT42Q
파생모델명 <i>Series Model Number</i>	MDBT42Q-P, MDBT42Q-U
인증번호 <i>Certification No.</i>	MSIP-CRM-ryt-MDBT42Q
제조사/제조국가 <i>Manufacturer/ Country of Origin</i>	Raytac Corporation / 대만
인증연월일 <i>Date of Certification</i>	2016-10-06
기타 <i>Others</i>	
<p>위 기자재는 「전파법」 제58조의2 제2항에 따라 인증되었음을 증명합니다.</p> <p>It is verified that foregoing equipment has been certificated under the Clause 2, Article 58-2 of Radio Waves Act.</p> <p style="text-align: right;">2019년(Year) 05월(Month) 14일(Day)</p> <p style="text-align: center;">국립전파연구원장 </p> <p style="text-align: center;"><i>Director General of National Radio Research Agency</i></p> <p style="text-align: center; color: red; font-size: small;">※ 인증 받은 방송통신기자재는 반드시 "적합성평가표시" 를 부착하여 유통하여야 합니다. 위반시 과태료 처분 및 인증이 취소될 수 있습니다.</p>	



9.9. RoHS & REACH Report

Please visit "[Support](#)" page of our website to download.

9.10. End-Product Label

It is suggested using following content adding to package or user manual or label to obey the regulation. Any rules of end-product label shall refer to each certification for final reference.

9.10.1. FCC (USA)

The FCC statement should be included in the user manual when there is no enough space on label. Otherwise, it should be included on the label.

"This device complies with part 15 of the FCC rules. Operation is subject to the following two conditions. (1) This device may not cause harmful interference. (2) This device must accept any interference received, including interference that may cause undesired operation."

The final end product must be labeled in a visible area with the following: "Contain FCC ID: SH6MDBT42Q".

9.10.2. TELEC (Japan)

When manufacturer is placing the product on the Japanese market, the product must be affixed with the following Specified Radio Equipment marking:

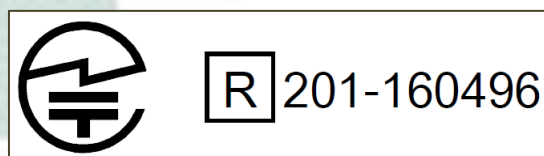

9.10.3. NCC (Taiwan)

請依下列標籤式樣自製標籤，標貼或印鑄於器材本體明顯處，始得販賣或公開陳列。

MDBT42Q Series

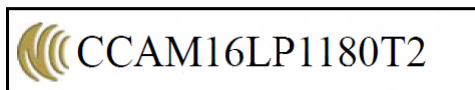

MDBT42Q-P Series

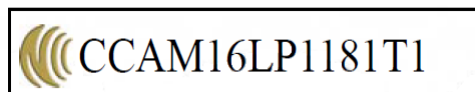

平台廠商必須於平台上標示字樣「本產品內含射頻模組：ID 編號 CCAM16LP1180T2」或「本產品內含射頻模組：ID 編號 CCAM16LP1181T1」。

「平台」定義如下：若器材組裝本案模組，消費者仍能正常使用該器材主要功能，該器材得視為平台。若器材不組裝本案模組，消費者不能正常使用該器材主要功能，該器材不能視為平台。該類不同廠牌型號器材組裝本案審驗模組後，須分別申請型式認證。

9.10.4. IC (Canada)

The IC statement should be included in the user manual when there is no enough space on label. Otherwise, it should be included on the label.

“This device complies with Industry Canada license-exempt RSS Standard(s). Operation is subject to the following two conditions. (1) This device may not cause harmful interference. (2) This device must accept any interference received, including interference that may cause undesired operation.

Le présent appareil est conforme aux CNR d'Industrie Canada applicables aux appareils radio exempts de licence. L'exploitation est autorisée aux deux conditions suivantes: (1) l'appareil ne doit pas produire de brouillage, et (2) l'utilisateur de l'appareil doit accepter tout brouillage radioélectrique subi, même si le brouillage est susceptible d'en compromettre le fonctionnement.”

The final end product must be labeled in a visible area with the following: “Contain IC ID: 8017A-MDBT42Q”.

10. Notes and Cautions

Module is not designed to last for a lifetime. Like general products, it is expected to be worn out after continuous usage through the years. To assure that product will perform better and last longer, please make sure you:

- Follow the guidelines of this document while designing circuit/end-product. Any discrepancy of core Bluetooth technology and technical specification of IC should refer to definition of Bluetooth Organization and Nordic Semiconductor as final reference.
- Do not supply voltage that is not within range of specification.
- Eliminate static electricity at any cost when working with the module as it may cause damage. It is highly recommended adding anti-ESD components to circuit design to prevent damage from real-life ESD events. Anti-ESD methods can be also applied in mechanical design.
- Do not expose modules under direct sunlight for long duration. Modules should be kept away from humid and salty air conditions, and any corrosive gasses or substances. Store it within -40°C to $+125^{\circ}\text{C}$ before and after installation.
- Avoid any physical shock, intense stress to the module or its surface.
- Do not wash the module. No-Clean Paste is used in production. Washing it will oxidize the metal shield and have chemistry reaction with No-Clean Paste. Functions of the module are not guaranteed if it has been washed.

The module is not suitable for life support device or system and not allowed to be used in destructive device or systems in any direct or indirect ways. The customer agrees to indemnify Raytac for any losses when applying modules in applications such as the ones described above.

11. Basic Facts for nRF52 Chip

Below is the comparison chart between nRF52840, nRF52832, nRF52810 & nRF52811. Any discrepancy shall refer to Nordic's technical document as final reference.

	nRF52840	nRF52832	nRF52810	nRF52811
RAYTAC Model No.	MDBT50Q Series	MDBT42Q-512KV2 MDBT42Q-P512KV2 MDBT42 series MDBT42V series	MDBT42Q-192K MDBT42Q-P192K	MDBT42Q-192KL MDBT42Q-P192KL
Bluetooth 5 Long Range (125kbps)	V			V
Bluetooth 5 High Speed	V	V	V	V
Bluetooth 5 Ad. Extention (x8)	V	V	V	V
Flash (kBytes)	1024	512	192	192
RAM (kBytes)	256	64	24	24
ANT Plus	V	V	V	V
IEEE 802.15.4	V			V
ARM® TrustZone® Cryptocell	V			
USB	V			
QSPI	V			
NFC	V	V		
I2S	V	V		
SPI, TWI, UART, PWM	V	V	V	V
PDM	V	V	V	V
ADC, Comparators	V	V	V	V
Supply Range (V)	1.7 to 5.5	1.7 to 3.6	1.7 to 3.6	1.7 to 3.6

12. Useful Links

- **Nordic Infocenter:** <https://infocenter.nordicsemi.com/index.jsp>
All the necessary technical files and software development kits of Nordic's chip are on this website.
- **Nordic DevZone:** <https://devzone.nordicsemi.com/questions/>
A highly recommended website for firmware developer. Interact with other developers and Nordic's employees will help with your questions. The site also includes tutorials in detail to help you get started.
- **Official Page of nRF52832:**
<https://www.nordicsemi.com/eng/Products/Bluetooth-low-energy/nRF52832>
A brief introduction to nRF52832 and download links for Nordic's developing software and SoftDevices.

Full List of Raytac's BLE Modules



MDBT40 & MDBT40-P Series

Series	Nordic Solution	Raytac No.	IC Version	Antenna	RAM	Flash Memory
MDBT40	nRF51822	MDBT40-256V3	3	Chip Antenna	16 kb	256 K
		MDBT40-256RV3			32 kb	256 K
MDBT40-P	nRF51822	MDBT40-P256V3	3	PCB Antenna	16 kb	256 K
		MDBT40-P256RV3			32 kb	256 K
MDBT40 - ANT	nRF51422	MDBT40-ANT-256V3	3	Chip Antenna	16 kb	256 K
		MDBT40-ANT-256RV3			32 kb	
MDBT40 - ANT-P	nRF51422	MDBT40-ANT-P256V3	3	PCB Antenna	16 kb	256 K
		MDBT40-ANT-P256RV3			32 kb	
MDBT40 Nano	nRF51822	MDBT40-n256V3	3	N/A	16 kb	256 K
MDBT40 - ANT-Nano	nRF51422	MDBT40-ANT-n256V3	3	N/A	16 kb	256 K

MDBT42Q Series (QFN Package IC)

Series	Nordic Solution	Raytac No.	IC Version	Antenna	RAM	Flash Memory
MDBT42Q	nRF52832	MDBT42Q-512KV2	2	Chip Antenna	64 kb	512 K
	nRF52810	MDBT42Q-192K	1		24 kb	192 K
	nRF52811	MDBT42Q-192KL	1			

MDBT42Q-P	nRF52832	MDBT42Q-P512KV2	2	PCB Antenna	64 kb	512 K
	nRF52810	MDBT42Q-P192K	1		24 kb	192 K
	nRF52811	MDBT42Q-P192KL	1			

MDBT42Q-U	nRF52832	MDBT42Q-U512KV2	2	u.FL Connector	64 kb	512 K
-----------	----------	-----------------	---	----------------	-------	-------

MDBT42 Series (WLCSP Package IC)

Series	Nordic Solution	Raytac No.	IC Version	Antenna	RAM	Flash Memory
MDBT42	nRF52832	MDBT42-512KV2	2	Chip Antenna	64 kb	512 K
MDBT42-P		MDBT42-P512KV2		PCB Antenna		

Series	Nordic Solution	Raytac No.	IC Version	Antenna	RAM	Flash Memory
MDBT42V	nRF52832	MDBT42V-512KV2	2	Chip Antenna	64 kb	512 K
MDBT42V-P		MDBT42V-P512KV2		PCB Antenna		

MDBT50Q Series (aQFN Package IC)

Series	Nordic Solution	Raytac No.	IC Version	Antenna	RAM	Flash Memory
MDBT50Q	nRF52840	MDBT50Q-1MV2	2	Chip Antenna	256 kb	1MB
MDBT50Q-P		MDBT50Q-P1MV2		PCB Antenna		
MDBT50Q-U		MDBT50Q-U1MV2		u.FL Connector		

Dongle	nRF52840	MDBT50Q-RX	1, 2	PCB Antenna	256 kb	1MB
--------	----------	------------	------	-------------	--------	-----

Release Note

- 2016/03/24 Version A: 1st release
- 2016/08/26 Version B:
 - (1) Updated list of Raytac's BLE model no..
 - (2) Added schematic of MDBT42Q-P and RF layout reference in Chapter 2.
 - (3) Updated packing info in Chapter 4.
 - (4) Added antenna info in Chapter 7.
 - (5) Updated info of regional certificates in Chapter 9.
- 2017/05/22 Version C:
 - (1) Added CE Test Report (RED directives), Declaration ID certificate, and KC certificate.
Updated FCC and IC certificate for portable device.
 - (2) Updated layout & footprint guide in Chapter 2.
- 2017/07/31 Version D:
 - (1) Updated RF layout guide in Chapter 2.
 - (2) Updated RoHS & REACH reports.
- 2017/10/31 Version E:
 - (1) Updated Chapter 2, Chapter 9 and list of model no.
 - (2) Added Chapter 10: Basic Facts for nRF52 Chip.
- 2018/04/11 Version F:
 - (1) Updated model no. to MDBT42Q-512KV2, MDBT42Q-P512KV2 for V2 IC and updated info in Chapter 4 and list of model no.
 - (2) Corrected typo in schematic of Chapter 8.
 - (3) Added Chapter 10: Notes and Cautions and Chapter 12: Useful Links.
- 2018/07/30: Version G:
 - (1) Added remarks of P0.23/P0.24 and updated link of design guide in Chapter 2.
 - (2) Updated technical spec in Chapter 5.
 - (3) Added CE EN300 328 (RED) compliant proof and updated link for RoHS & REACH report in Chapter 9.
 - (4) Added "no washing" note in Chapter 10.
- 2018/12/06 Version H:
 - (1) Added packaging info and order code in Chapter 4.
 - (2) Refined description of default setting in Chapter 8.

(3) Added link of Documentation Library in Chapter 12.

(4) Added new item “MDBT50Q-RX” in full list of Raytac’s model no.

● 2019/06/14 Version I:

(1) Updated description of test code in Chapter 8: Reference Circuit..

(2) Added BT 5.0 certificates in Chapter 9: Certification.

(3) Added nRF52811 information in Chapter 11: Basic Facts for nRF52 Chip.

(4) Removed link of Nordic Documentation Library in Chapter 12: Useful Links.

(5) Added MDBT42Q-U in Full List of Raytac’s BLE Modules.

