

Approval Sheet

(產品承認書)

產品名稱 (Product):	BT 5.0 Module (nRF52840)
產品型號 (Model No.):	MDBT50Q – 1MV2 (Chip Antenna)
	MDBT50Q – P1MV2 (PCB Antenna)
產品料號 (Part No.):	see 4.3 Order Code

Working distance of MDBT50Q-1MV2 & MDBT50Q-P1MV2:

- **1Mbps:**
MDBT50Q: over 300 meters in open space.
MDBT50Q-P: up to 250 meters in open space.
- **2Mbps:**
MDBT50Q: over 150 meters in open space.
MDBT50Q-P: up to 120 meters in open space.

Index

1. Overall Introduction	4
1.1. Application	4
1.2. Features	5
2. Product Dimension	7
2.1. PCB Dimensions & Pin Indication.....	7
2.2. Recommended Layout of Solder Pad.....	9
2.3. RF Layout Suggestion (aka Keep-Out Area)	13
2.4. Footprint & Design Guide	15
2.5. Pin Assignment.....	16
2.6. GPIO Located Near the Radio.....	19
3. Main Chip Solution.....	19
4. Shipment Packaging Information	20
4.1. Marking on Metal Shield	21
4.2. Packaging Info.....	21
4.3. Order Code.....	23
5. Specification	24
5.1. Absolute Maximum Ratings	24
5.2. Operating Conditions.....	24
5.3. Electrical Specifications.....	25
6. Block Diagram	31
7. Antenna.....	32
7.1. MDBT50Q-1M	32
7.2. MDBT50Q-P1M	34
8. Reference Circuit.....	36
8.1. Reg0 DC/DC Enabled.....	37
8.2. Reg0 LDO Mode.....	38
8.3. Reg0 DC/DC and LDO Mode Disabled.....	39
8.4. USB Disabled	40
9. Certification	41
9.1. Declaration ID.....	41
9.2. FCC Certificate (USA)	42
9.3. TELEC Certificate (Japan).....	43
9.4. NCC Certificate (Taiwan)	45
9.5. CE (EU) & RCM (Australia & New Zealand) Test Report.....	47

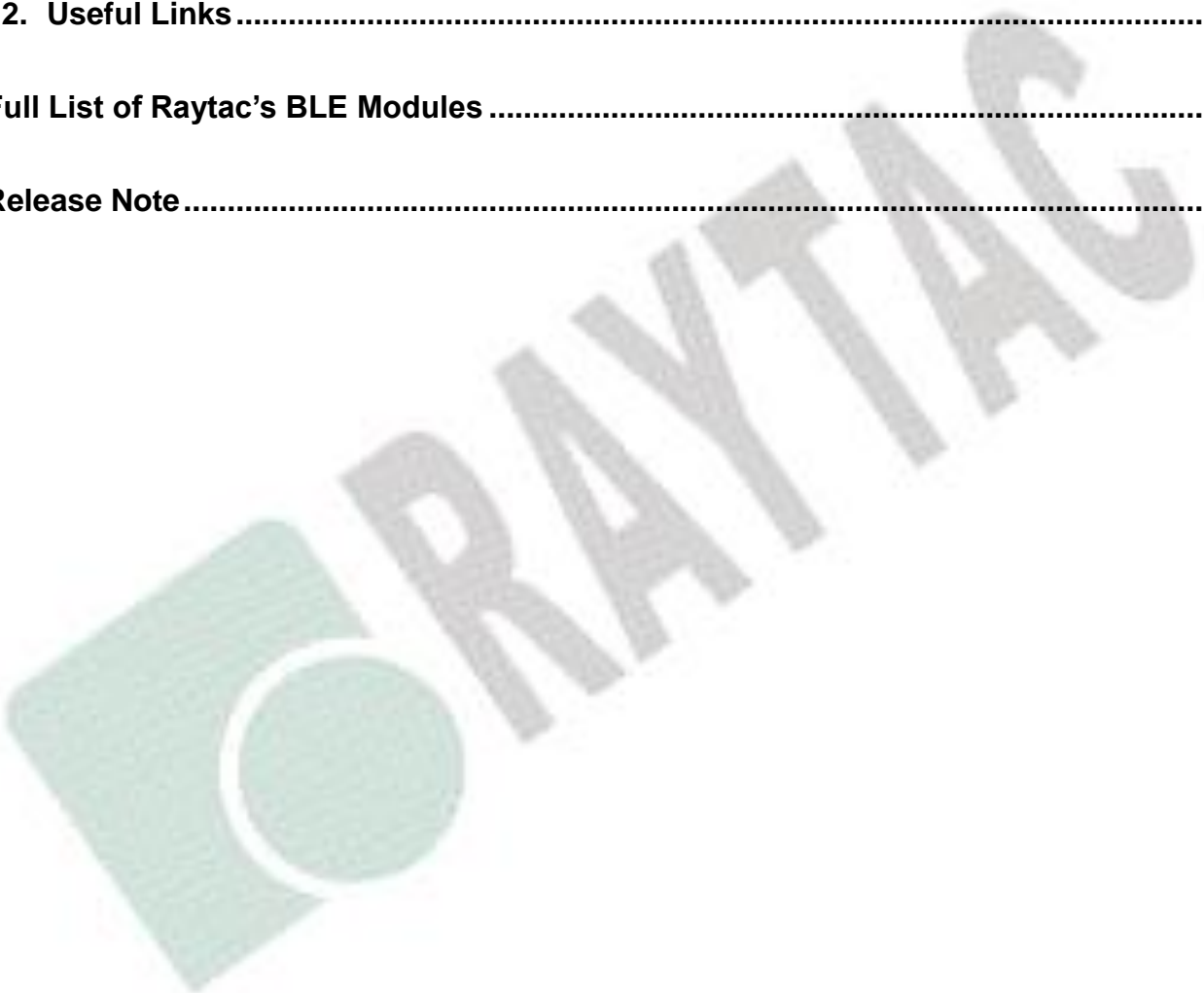

9.6. IC Certificate (Canada).....	50
9.7. SRRC Certificate (China).....	51
9.8. KC Certificate (South Korea)	52
9.9. WPC (ETA) Certificate (India).....	53
9.10. RoHS & REACH Report	54
10. Notes and Cautions.....	55
11. Basic Facts for nRF52 Chip.....	56
12. Useful Links	57
Full List of Raytac’s BLE Modules	58
Release Note.....	61



1. Overall Introduction

Raytac's MDBT50Q & MDBT50Q-P is a BT 5.0 stack (Bluetooth low energy or BLE) module designed based on **Nordic nRF52840 SoC solution**, which incorporates: **GPIO, SPI, UART, I2C, I2S, PMD, PWM, ADC, NFC** and **USB** interfaces for connecting peripherals and sensors.

Features of the module:

1. Embedded 2.4GHz transceiver supports Bluetooth 5 ( Bluetooth[®]), IEEE 802.15.4 ( THREAD & Zigbee) & 2.4Ghz RF & ANT⁺ upon customer's preference.
2. Compact size with **(L) 15.5 x (W) 10.5 x (H) 2.2 or 2.0 mm**.
3. Low power requirements, ultra-low peak, average and idle mode power consumption.
4. Be compatible with a large installed base of mobile phones, tablets and computers.
5. Fully coverage of BLE software stack.
6. BLE & RF transmission switching helps products fit all operation system and most hardware.

1.1. Application

- IoT Networks
 - Smart home (such as door locks, lighting) sensors and controllers
 - Smart city sensor networks
 - Industrial IoT sensors and controllers
 - Connected white goods
- Personal Area Networks
 - Health / fitness sensor and monitor device
 - Medical device
- Interactive entertainment devices
 - Advanced remote controls
 - Gaming controller
- Advanced wearables
 - Connected watches
 - Advanced personal fitness devices
 - Wearables with wireless secure payment
 - Connected Health
 - Virtual/Augmented Reality applications
- High performance HID Controllers
- Mesh Network

1.2. Features

- Bluetooth 5, IEEE 802.15.4, 2.4 GHz transceiver
 - -95dBm sensitivity in 1Mbps Bluetooth low energy (BLE) mode
 - -103dBm sensitivity in 125Kbps BLE mode (long range)
 - +8 dBm TX power (down to -20 dBm in 4 dB steps)
 - On-air compatible with nRF52, nRF51, nRF24L and nRF24AP Series
 - Programmable output power from +8dBm to -20dB
 - RSSI (1dB resolution)
 - Supported data rates:
 - Bluetooth 5: 2 Mbps, 1 Mbps, 500 kbps, 125 kbps
 - IEEE 802.15.4-2006: 250 kbps
 - Proprietary 2.4 GHz: 2 Mbps, 1 Mbps
- ARM Cortex –M4 32-bit processor with FPU, 64 MHz
- Memory: 1MB flash / 256KB RAM
- HW accelerated security
 - ARM TrustZone Cryptocell 310 security subsystem
 - 128 bit AES / ECB / CCM / AAR co-processor (on-the-fly packet encryption)
- Advanced on-chip interfaces
 - USB 2.0 full speed (12Mbps) controller
 - QSPI 32MHz interface
 - High speed 32MHz SPI
 - Type 2 near field communication (NFC-A) tag with wake-on field
 - Programmable peripheral interconnect (PPI)
 - 48 general purpose I/O pins
 - EasyDMA automated data transfer between memory and peripherals.
- 12 bit, 200ksps ADC – 8 configurable channels with programmable gain
- 4 x 4 channel pulse width modulator (PWM) units with EasyDMA
- Audio peripherals : I2S, digital microphone interface (PDM)
- 5 X 32-bit timers with counter mode
- Up to 4 x SPI masters / 3 x SPI slaves with EasyDMA
- Up to 2 x I2C compatible 2-wire masters / slaves
- 2 x UART(CTS/RTS) with EasyDMA
- Quadrature decoder (QDEC)
- 3 x 24-bit real-time counters (RTC)

- Flexible power management
 - Supply voltage range 1.7V to 5.5V
 - On-chip DC/DC and LDO regulators with automated low current modes
 - Regulated supply for external components from 1.8V to 3.3V
 - Automated peripheral power management
 - Fast wake-up using 64MHz internal oscillator
 - 0.4uA at 3V in System OFF mode, no RAM retention
 - 1.5uA at 3V in System ON mode, no RAM retention, wake on RTC
- Nordic SoftDevice ready and with support for concurrent multi-protocol



2. Product Dimension

2.1. PCB Dimensions & Pin Indication

- **MDBT50Q**

PCB SIZE: (L) 15.5 x (W) 10.5x (H) 2.2 mm

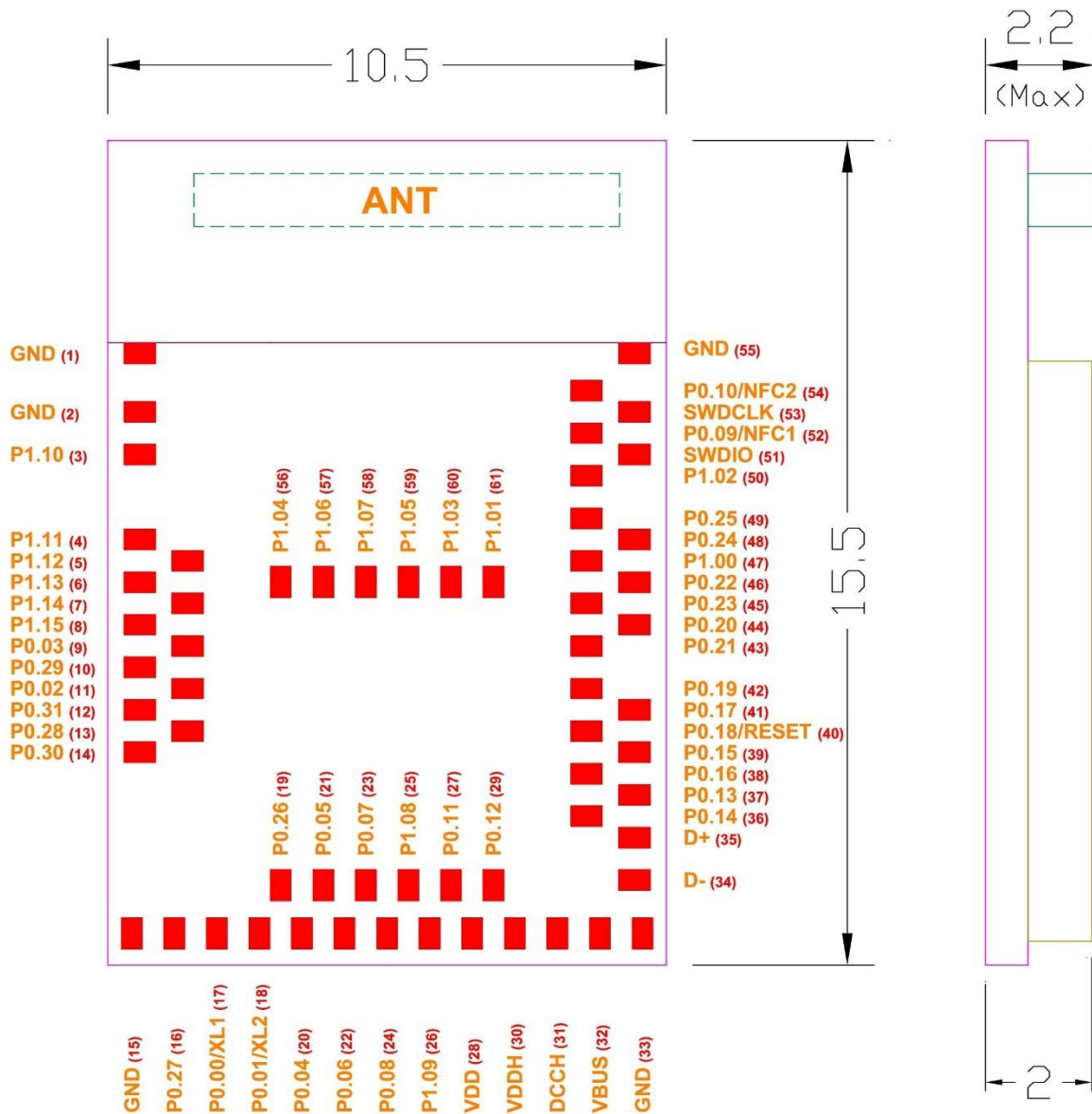

Top 單位:(mm)

• **MDBT50Q-P**

PCB SIZE: (L) 15.5 x (W) 10.5 x (H) 2.0 mm

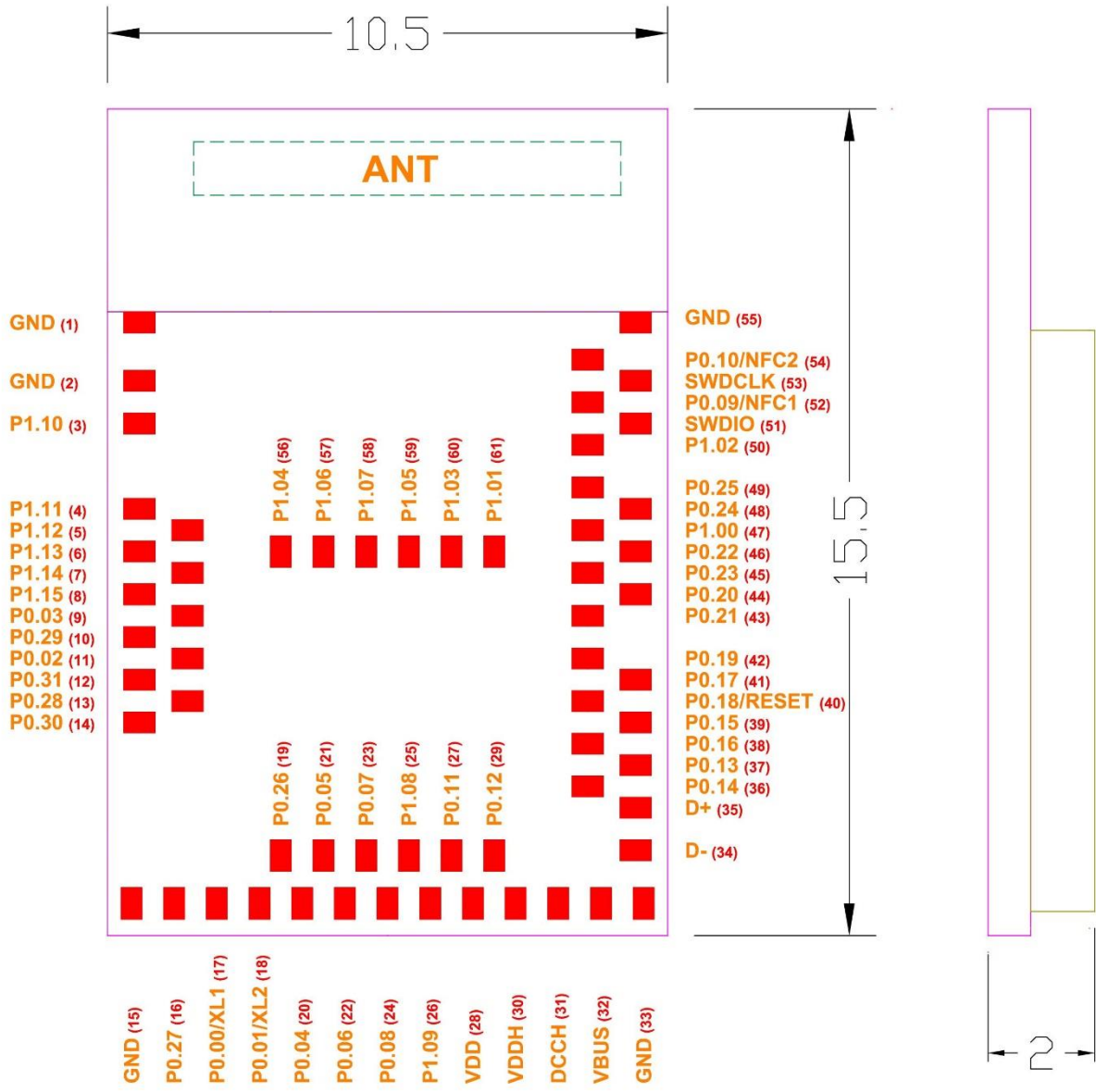

Top 單位:(mm)

2.2. Recommended Layout of Solder Pad

Graphs are all in Top View, Unit in mm.

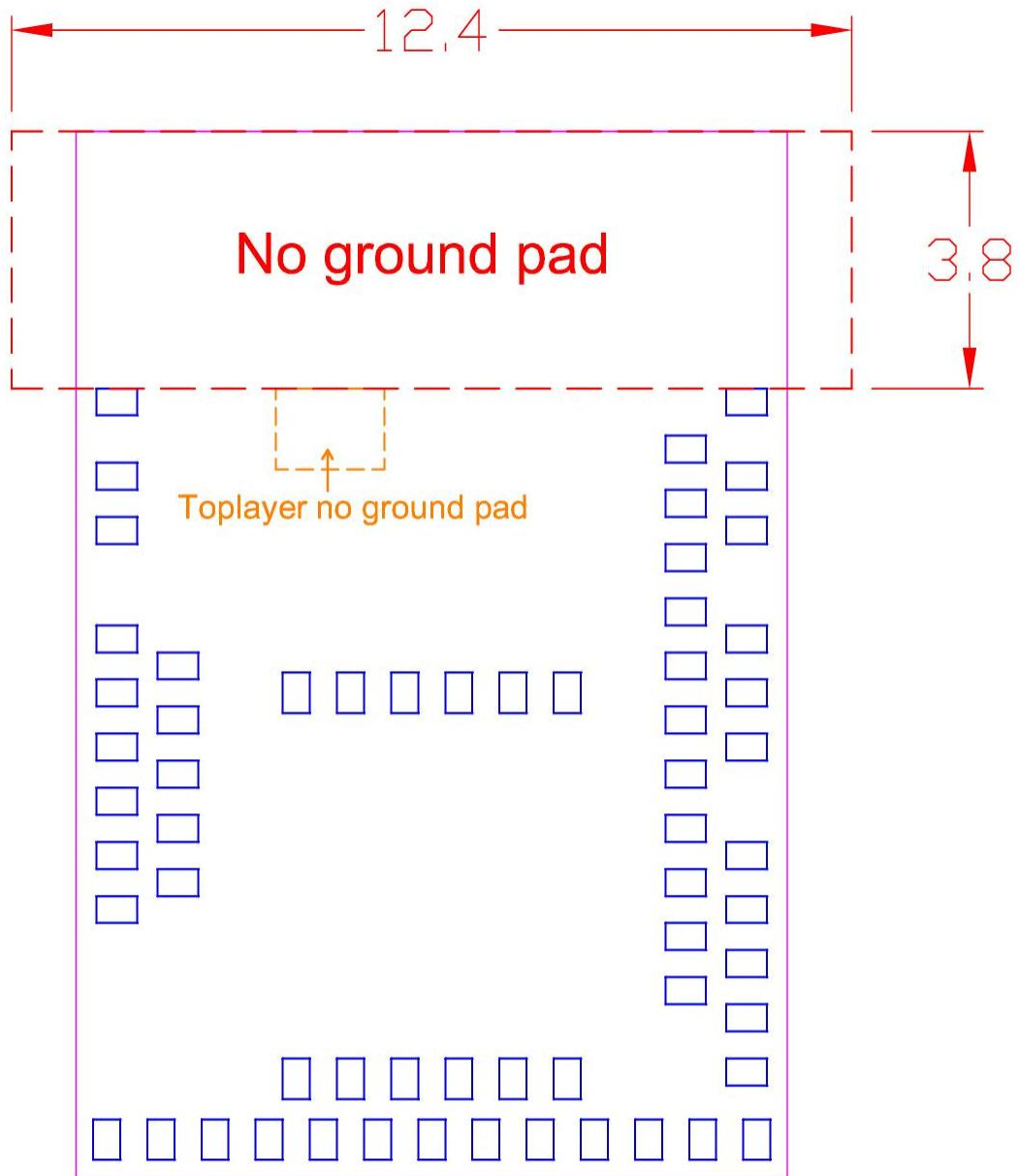

No ground pad

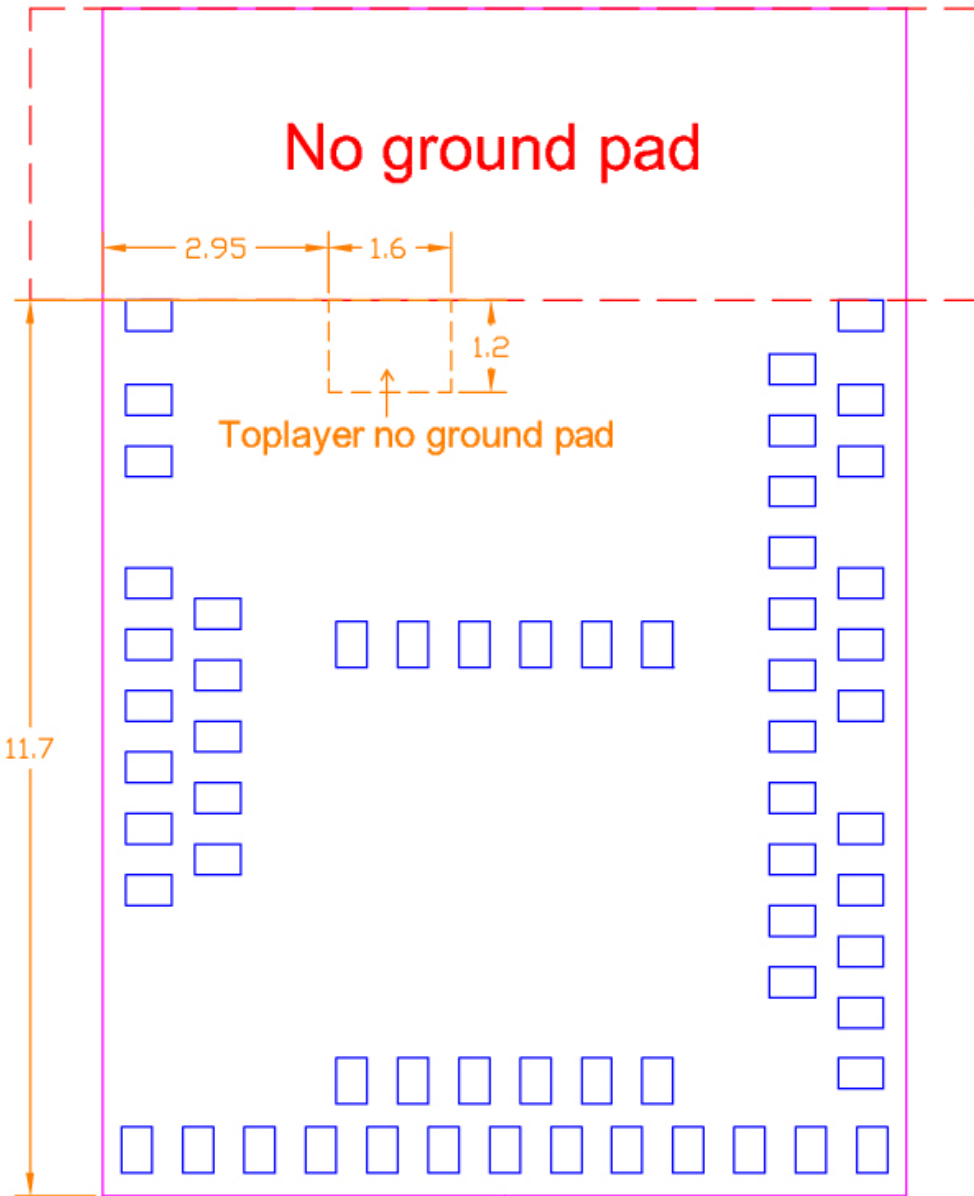

Toplayer no ground pad

No ground pad

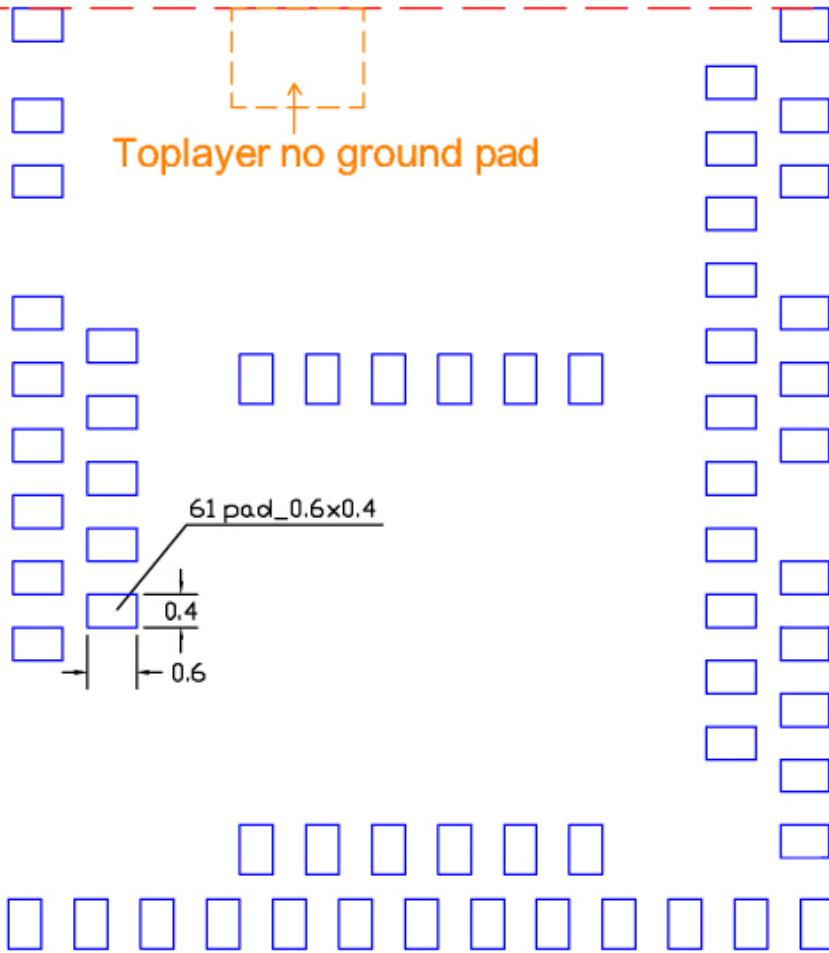

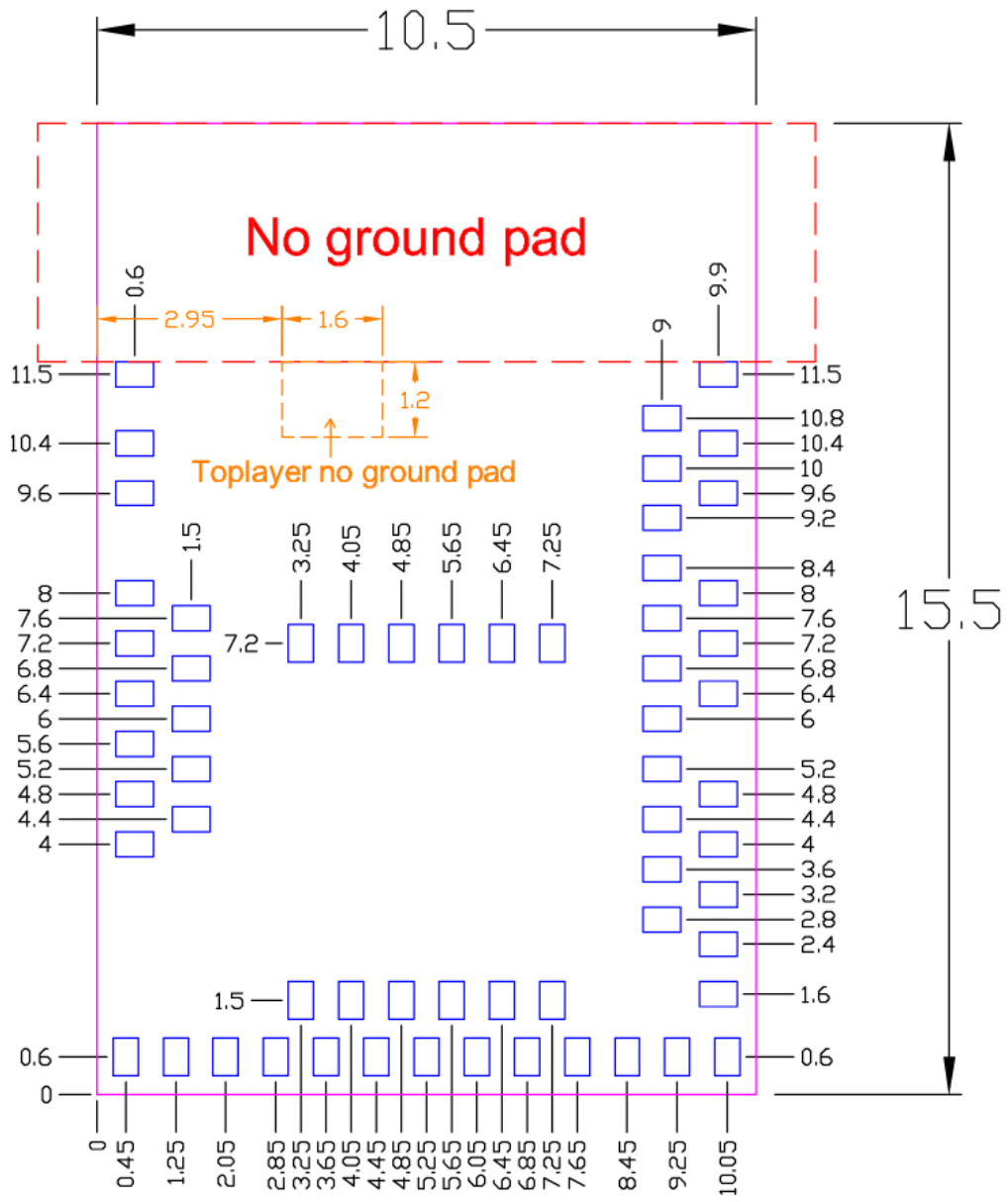

Top View (單位：mm)
recommended solder pad layout

2.3. RF Layout Suggestion (aka Keep-Out Area)

Please follow below instruction to have better wireless performance. Make sure to keep the “No-Ground-Pad” as wider as you can when there is no enough space in your design.

Welcome to send us your layout in PDF for review at service@raytac.com or your contact at Raytac with title “Layout reviewing – Raytac Model No. – YOUR company’s name”.

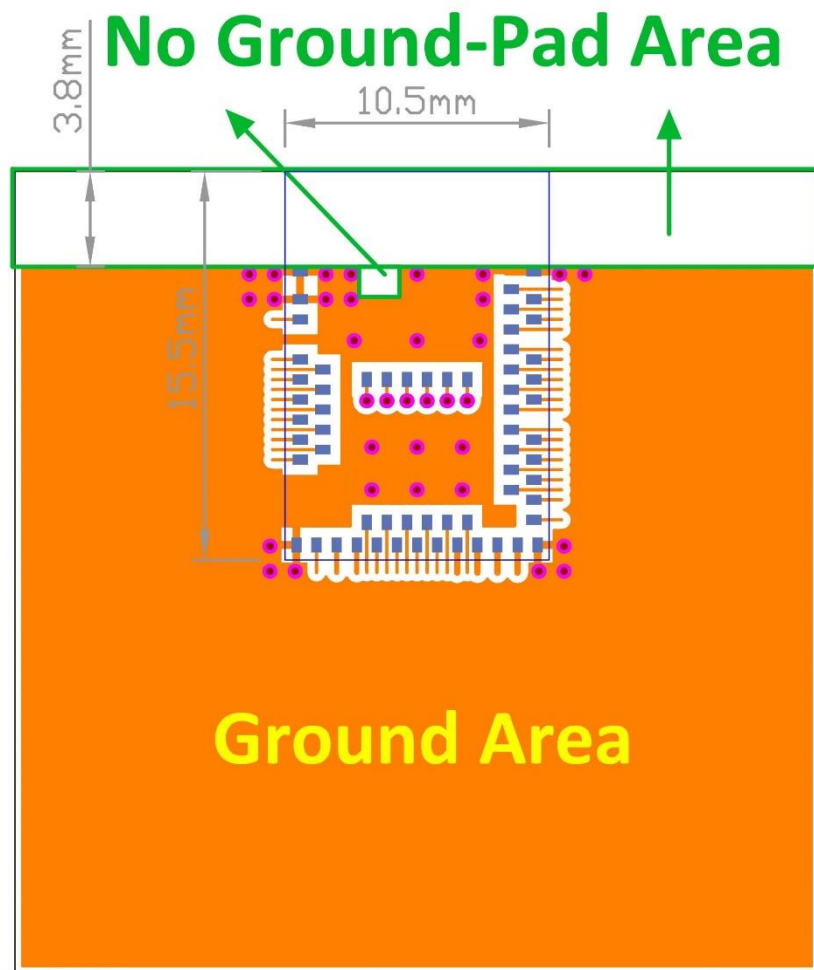

Top layer

Please add via holes in GROUND area as many as possible, especially around the four corners.

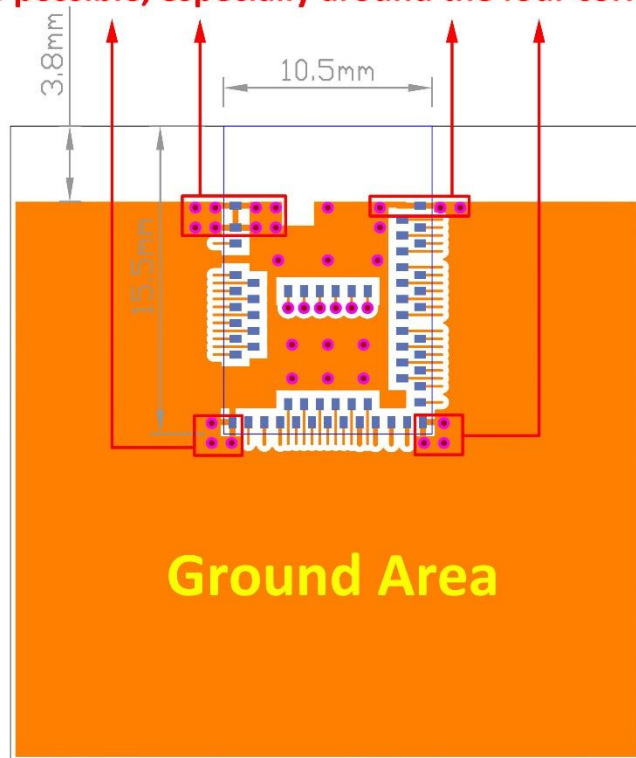

Top layer

No Ground-Pad Area

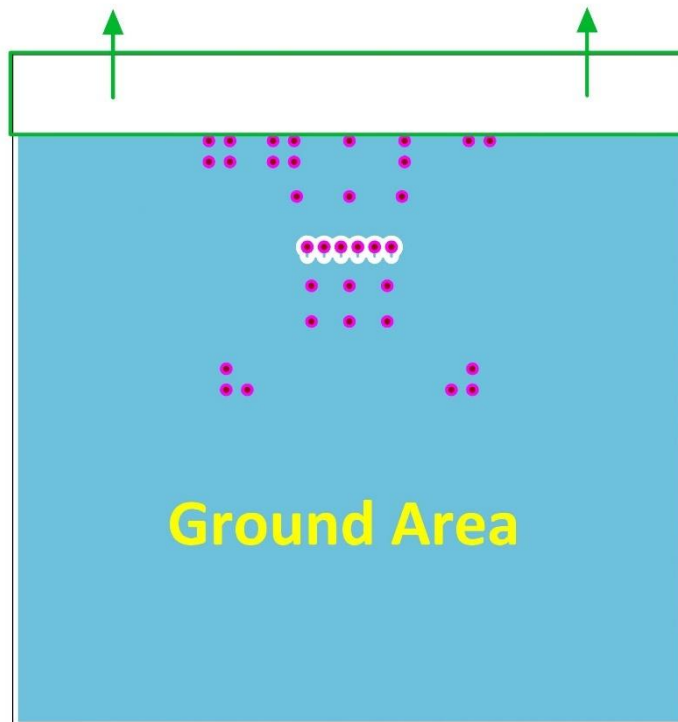

Bottom layer

Examples of “**NOT RECOMMENDED**” layout

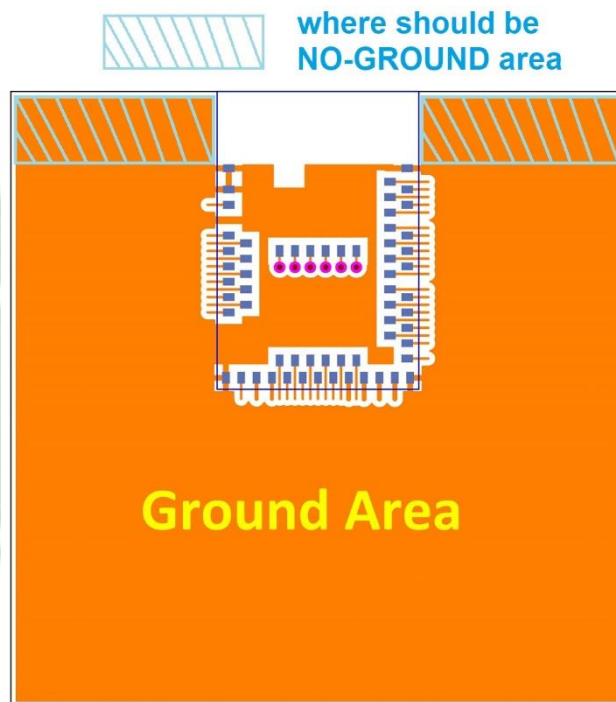
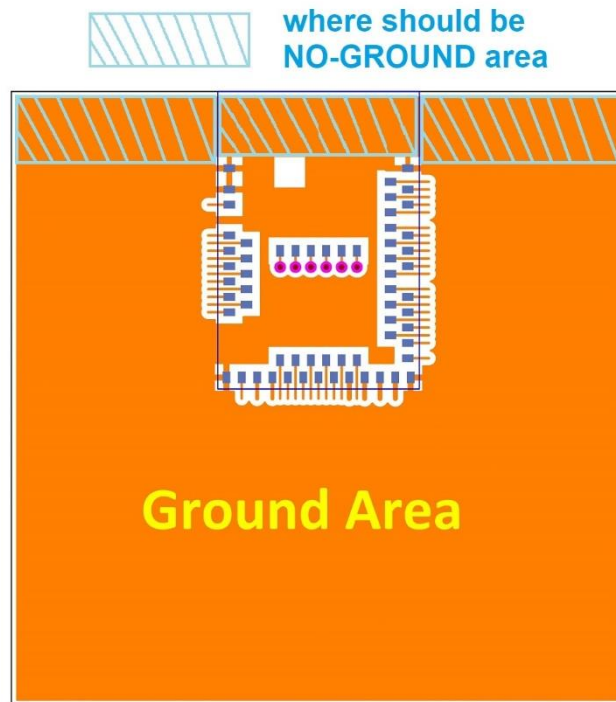

2.4. Footprint & Design Guide

Please visit “[Support](#)” page of our website to download. The package includes footprint, 2D/3D drawing, reflow graph/solder profile and recommended spec for external 32.768khz.

2.5. Pin Assignment

Pin No.	Name	Pin Function	Description
(1)	GND	Power	Ground
(2)	GND	Power	Ground
(3)	P1.10	Digital I/O	General-purpose I/O (standard drive, low frequency I/O only)
(4)	P1.11	Digital I/O	General-purpose I/O (standard drive, low frequency I/O only)
(5)	P1.12	Digital I/O	General-purpose I/O (standard drive, low frequency I/O only)
(6)	P1.13	Digital I/O	General-purpose I/O (standard drive, low frequency I/O only)
(7)	P1.14	Digital I/O	General-purpose I/O (standard drive, low frequency I/O only)
(8)	P1.15	Digital I/O	General-purpose I/O (standard drive, low frequency I/O only)
(9)	P0.03	Digital I/O	General-purpose I/O (standard drive, low frequency I/O only)
	AIN1	Analog input	Analog input
(10)	P0.29	Digital I/O	General-purpose I/O (standard drive, low frequency I/O only)
	AIN5	Analog input	Analog input
(11)	P0.02	Digital I/O	General-purpose I/O (standard drive, low frequency I/O only)
	AIN0	Analog input	Analog input
(12)	P0.31	Digital I/O	General-purpose I/O (standard drive, low frequency I/O only)
	AIN7	Analog input	Analog input
(13)	P0.28	Digital I/O	General-purpose I/O (standard drive, low frequency I/O only)
	AIN4	Analog input	Analog input

Pin No.	Name	Pin Function	Description
(14)	P0.30	Digital I/O	General-purpose I/O (standard drive, low frequency I/O only)
	AIN6	Analog input	Analog input
(15)	GND	Power	Ground
(16)	P0.27	Digital I/O	General-purpose I/O
(17)	P0.00	Digital I/O	General-purpose I/O
	XL1	Analog input	Connection for 32.768 kHz crystal
(18)	P0.01	Digital I/O	General-purpose I/O
	XL2	Analog input	Connection for 32.768 kHz crystal
(19)	P0.26	Digital I/O	General-purpose I/O
(20)	P0.04	Digital I/O	General-purpose I/O
	AIN2	Analog input	Analog input
(21)	P0.05	Digital I/O	General-purpose I/O
	AIN3	Analog input	Analog input
(22)	P0.06	Digital I/O	General-purpose I/O
(23)	P0.07	Digital I/O	General-purpose I/O
	TRACECLK	Trace clock	Trace buffer clock
(24)	P0.08	Digital I/O	General-purpose I/O
(25)	P1.08	Digital I/O	General-purpose I/O
(26)	P1.09	Digital I/O	General-purpose I/O
	TRACEDATA3	Trace data	Trace buffer TRACEDATA [3].
(27)	P0.11	Digital I/O	General-purpose I/O
	TRACEDATA2	Trace data	Trace buffer TRACEDATA[2].
(28)	VDD	Power	Power supply
(29)	P0.12	Digital I/O	General-purpose I/O
	TRACEDATA1	Trace data	Trace buffer TRACEDATA [1].
(30)	VDDH	Power	High voltage power supply
(31)	DCCH	Power	DC/DC converter output
(32)	VBUS	Power	5V input for USB 3.3V regulator

Pin No.	Name	Pin Function	Description
(33)	GND	Power	Ground
(34)	D-	Digital I/O	USB D-
(35)	D+	Digital I/O	USB D+
(36)	P0.14	Digital I/O	General-purpose digital I/O
(37)	P0.13	Digital I/O	General-purpose digital I/O
(38)	P0.16	Digital I/O	General-purpose digital I/O
(39)	P0.15	Digital I/O	General-purpose digital I/O
(40)	P0.18	Digital I/O	General-purpose digital I/O (recommended usage: QSPI / CSN)
	nRESET		Configurable as system RESET
(41)	P0.17	Digital I/O	General-purpose digital I/O
(42)	P0.19	Digital I/O	General-purpose digital I/O (recommended usage: (QSPI / SCK)
(43)	P0.21	Digital I/O	General-purpose digital I/O (recommended usage: QSPI)
(44)	P0.20	Digital I/O	General-purpose digital I/O
(45)	P0.23	Digital I/O	General-purpose digital I/O (recommended usage: QSPI)
(46)	P0.22	Digital I/O	General-purpose digital I/O (recommended usage: QSPI)
(47)	P1.00	Digital I/O	General-purpose digital I/O (recommended usage: QSPI)
	TRACEDATA0	Trace data	Trace buffer TRACEDATA [0].
(48)	P0.24	Digital I/O	General-purpose digital I/O
(49)	P0.25	Digital I/O	General-purpose digital I/O
(50)	P1.02	Digital I/O	General-purpose I/O (standard drive, low frequency I/O only)
(51)	SWDIO	Debug	Debug serial data
(52)	P0.09	Digital I/O	General-purpose I/O (standard drive, low frequency I/O only)
	NFC1	NFC input	NFC antenna connection
(53)	SWDCLK	Debug	Serial wire debug clock input for debug and programming

Pin No.	Name	Pin function	Description
(54)	P0.10	Digital I/O	General-purpose I/O (standard drive, low frequency I/O only)
	NFC2	NFC input	NFC antenna connection
(55)	GND	Power	Ground
(56)	P1.04	Digital I/O	General-purpose I/O (standard drive, low frequency I/O only)
(57)	P1.06	Digital I/O	General-purpose I/O (standard drive, low frequency I/O only)
(58)	P1.07	Digital I/O	General-purpose I/O (standard drive, low frequency I/O only)
(59)	P1.05	Digital I/O	General-purpose I/O (standard drive, low frequency I/O only)
(60)	P1.03	Digital I/O	General-purpose I/O (standard drive, low frequency I/O only)
(61)	P1.01	Digital I/O	General-purpose I/O (standard drive, low frequency I/O only)

2.6. GPIO Located Near the Radio



Please refer to [2.5 Pin Assignment](#) on page 16 to 18 where identifies some GPIO that have recommended usage. To maximize RF performance, these GPIO are only available to use under standard drive, low frequency I/O only, wrong usage may lead to undesirable performance.

3. Main Chip Solution

RF IC	Crystal Frequency
Nordic NRF52840	32MHZ

32MHz crystal and RF (VDD) DC/DC inductor (Reg1) are already inside the module.

4. Shipment Packaging Information

Antenna	Model
Chip/Ceramic Antenna	MDBT50Q-1MV2
	
PCB/Printed Antenna	MDBT50Q-P1MV2
	

Module with one black dot is using revision 1 IC. The one without black dot is using revision 2 IC and date code starts from 914 and after.

- Unit Weight of Module:

MDBT50Q-1MV2: 0.68 g / pc (± 0.02 g) ; MDBT50Q-P1MV2: 0.64 g / pc (± 0.02 g)

- Packaging Type: Anti-static tray or Tape & Reel only.

	Tray	Tape & Reel
MPQ (Min. Package Q'ty)	88 pcs per tray	1,056 pcs per reel
Carton Contents (per carton)	1,760 pcs	1,056 pcs
Carton Dimension (L) x (W) x (H) cm	37 x 21 x 13	37 x 36 x 6
Gross Weight	about 2.8 kgs	about 1.5 kgs

4.1. Marking on Metal Shield

Label contexts for date code 839 and after:

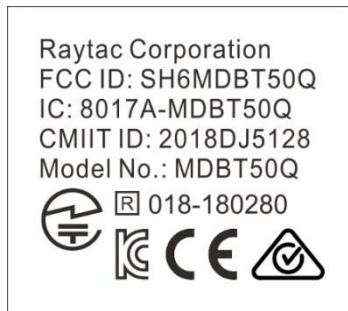

For date code 833 to 838:

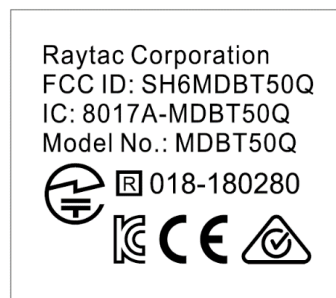

There is no marking on metal shield for module(s) with date code *before* 833.

4.2. Packaging Info

4.2.1. Tray Packaging

Anti-static tray is specifically designed for mass production. It can be used directly on SMT automatic machine.

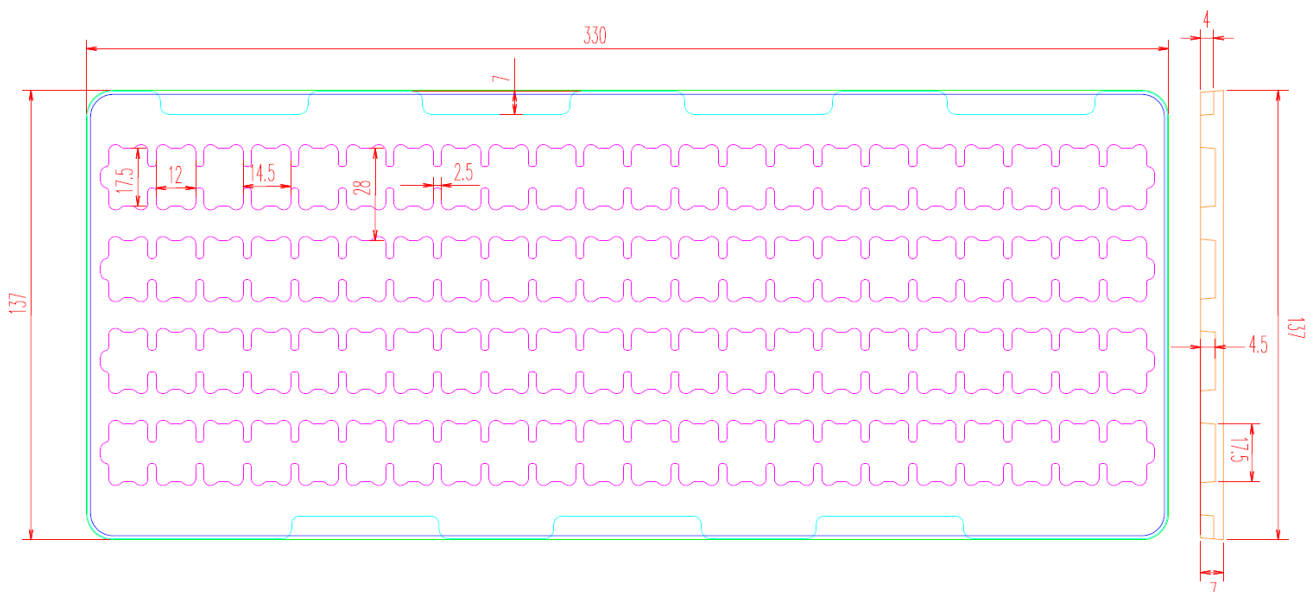

4.2.2. Tape & Reel Packaging

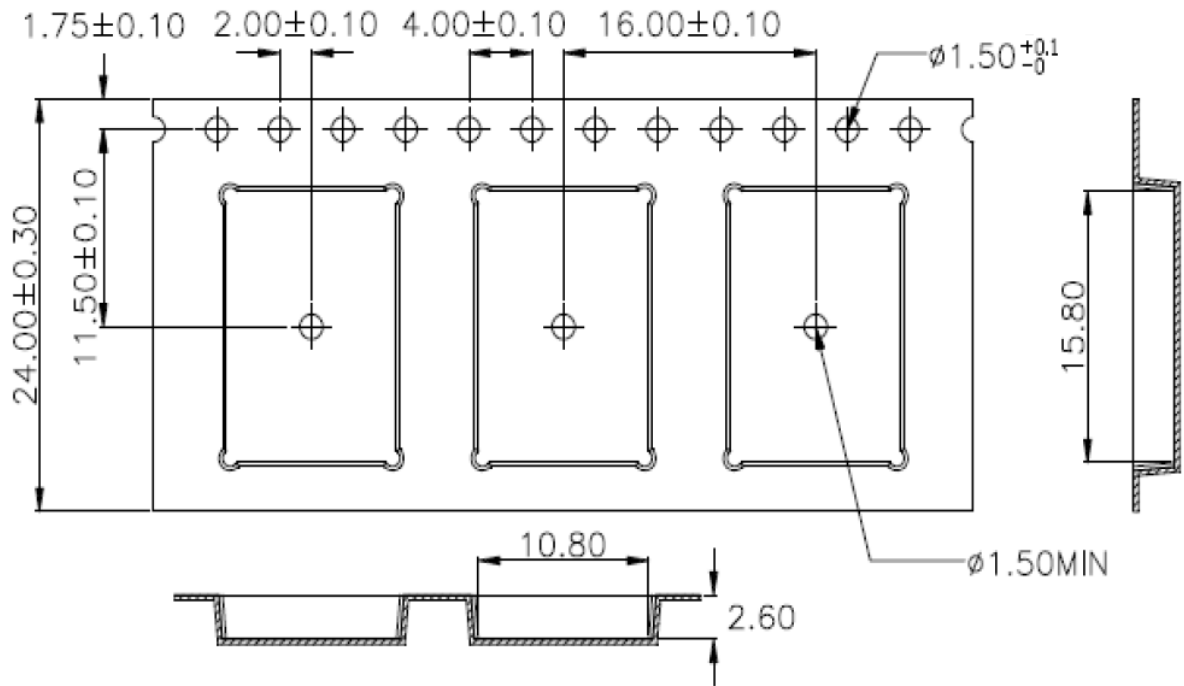

1	W	24.00	± 0.30
2	P1	16.00	± 0.10
3	E1	1.75	± 0.10
4	F	11.50	± 0.10
5	D0	1.50	$+0.1/-0$
6	P0	4.00	± 0.10
7	P0X10	40.00	± 0.20
8	P2	2.00	± 0.10
9	S0	-	
10	D1	-	
11	A0	10.80	± 0.10
12	B0	15.80	± 0.10
13	K0	2.60	± 0.10
14	K1	-	
15	T	0.30	± 0.05

4.3. Order Code

Each model has two options of packaging. Please use following part no. when placing order to us.

Note that MPQ of Reel packaging is 1,056 pcs and Tray packaging is 88 pcs.

<u>Tray</u> Packaging	MD-240A3-007 → MDBT50Q-1MV2
	MD-240A3-008 → MDBT50Q- P 1MV2
<u>Reel</u> Packaging	MD-240A3-007R → MDBT50Q-1MV2
	MD-240A3-008R → MDBT50Q- P 1MV2



5. Specification

Any technical spec shall refer to Nordic's official documents as final reference. Contents below are from "[nRF52840 Product Specification v1.1](#)", please click to download full spec.

5.1. Absolute Maximum Ratings

	Note	Min.	Max.	Unit
Supply voltages				
VDD		-0.3	+3.9	V
VDDH		-0.3	+5.8	V
VBUS		-0.3	+5.8	V
VSS			0	V
I/O pin voltage				
$V_{I/O}$, VDD ≤ 3.6 V		-0.3	VDD + 0.3	V
$V_{I/O}$, VDD > 3.6 V		-0.3	3.9	V
NFC antenna pin current				
$I_{NFC1/2}$			80	mA
Radio				
RF input level			10	dBm
Environmental aQFN™ package				
Storage temperature		-40	+125	°C
MSL	Moisture Sensitivity Level		2	
ESD HBM	Human Body Model		2	kV
ESD HBM Class	Human Body Model Class		2	
Flash memory				
Endurance		10 000		Write/erase cycles
Retention		10 years at 40°C		

5.2. Operating Conditions

Symbol	Parameter	Min.	Nom.	Max.	Units
VDD	VDD supply voltage, independent of DCDC enable	1.7	3.0	3.6	V
VDD _{POR}	VDD supply voltage needed during power-on reset	1.75			V
VDDH	VDDH supply voltage, independent of DCDC enable	2.5	3.7	5.5	V
VBUS	VBUS USB supply voltage	4.35	5	5.5	V
t_{R_VDD}	Supply rise time (0 V to 1.7 V)			60	ms
t_{R_VDDH}	Supply rise time (0 V to 3.7 V)			100	ms
TA	Operating temperature	-40	25	85	°C

*** The on-chip power-on reset circuitry may not function properly for rise times longer than the specified maximum.

5.3. Electrical Specifications

5.3.1. General Radio Characteristics

Symbol	Description	Min.	Typ.	Max.	Units
f_{OP}	Operating frequencies	2360		2500	MHz
$f_{PLL,CH,SP}$	PLL channel spacing		1		MHz
$f_{DELTA,1M}$	Frequency deviation @ 1 Mbps		±170		kHz
$f_{DELTA,BLE,1M}$	Frequency deviation @ BLE 1 Mbps		±250		kHz
$f_{DELTA,2M}$	Frequency deviation @ 2 Mbps		±320		kHz
$f_{DELTA,BLE,2M}$	Frequency deviation @ BLE 2 Mbps		±500		kHz
f_{skBps}	On the air data rate	125		2000	kbps
$f_{chip, IEEE 802.15.4}$	Chip rate in IEEE 802.15.4 mode		2000		kchips

5.3.2. Radio Current Consumption (Transmitter)

Symbol	Description	Min.	Typ.	Max.	Units
$I_{TX,PLUS8dBm,DCDC}$	TX only run current (DC/DC, 3 V) $P_{RF} = +8$ dBm	..	14.8	..	mA
$I_{TX,PLUS8dBm}$	TX only run current $P_{RF} = +8$ dBm	..	32.7	..	mA
$I_{TX,PLUS4dBm,DCDC}$	TX only run current (DC/DC, 3 V) $P_{RF} = +4$ dBm	..	9.6	..	mA
$I_{TX,PLUS4dBm}$	TX only run current $P_{RF} = +4$ dBm	..	21.4	..	mA
$I_{TX,0dBm,DCDC,5V,REG0HIGH}$	TX only run current (DC/DC, 5 V, REG0 out = 3.3 V) $P_{RF} = 0$ dBm		3.0		mA
$I_{TX,0dBm,DCDC,5V,REG0L}$	TX only run current (DC/DC, 5 V, REG0 out = 1.8 V) $P_{RF} = 0$ dBm		3.0		mA
$I_{TX,0dBm,DCDC}$	TX only run current (DC/DC, 3 V) $P_{RF} = 0$ dBm	..	4.8		mA
$I_{TX,0dBm}$	TX only run current $P_{RF} = 0$ dBm	..	10.6	..	mA
$I_{TX,MINUS4dBm,DCDC}$	TX only run current DC/DC, 3 V $P_{RF} = -4$ dBm	..	3.1	..	mA
$I_{TX,MINUS4dBm}$	TX only run current $P_{RF} = -4$ dBm	..	8.1	..	mA
$I_{TX,MINUS8dBm,DCDC}$	TX only run current DC/DC, 3 V $P_{RF} = -8$ dBm		3.3		mA
$I_{TX,MINUS8dBm}$	TX only run current $P_{RF} = -8$ dBm	..	7.2		mA
$I_{TX,MINUS12dBm,DCDC}$	TX only run current DC/DC, 3 V $P_{RF} = -12$ dBm		3.0		mA
$I_{TX,MINUS12dBm}$	TX only run current $P_{RF} = -12$ dBm	..	6.4	..	mA
$I_{TX,MINUS16dBm,DCDC}$	TX only run current DC/DC, 3 V $P_{RF} = -16$ dBm		2.8		mA
$I_{TX,MINUS16dBm}$	TX only run current $P_{RF} = -16$ dBm	..	6.0	..	mA
$I_{TX,MINUS20dBm,DCDC}$	TX only run current DC/DC, 3 V $P_{RF} = -20$ dBm		2.7		mA
$I_{TX,MINUS20dBm}$	TX only run current $P_{RF} = -20$ dBm	..	5.6	..	mA

5.3.3. Radio Current Consumption (Receiver)

Symbol	Description	Min.	Typ.	Max.	Units
$I_{RX,1M,DCDC}$	RX only run current (DC/DC, 3 V) 1 Mbps / 1 Mbps BLE	..	4.6	..	mA
$I_{RX,1M}$	RX only run current (LDO, 3 V) 1 Mbps / 1 Mbps BLE	..	9.9	..	mA
$I_{RX,2M,DCDC}$	RX only run current (DC/DC, 3 V) 2 Mbps / 2 Mbps BLE	..	5.2	..	mA
$I_{RX,2M}$	RX only run current (LDO, 3 V) 2 Mbps / 2 Mbps BLE	..	11.1	..	mA
$I_{START,RX,1M,DCDC}$	RX start-up current (DC/DC, 3 V) 1 Mbps / 1 Mbps BLE		3.7		mA
$I_{START,RX,1M}$	RX start-up current 1 Mbps / 1 Mbps BLE		6.7		mA

5.3.4. Transmitter Specification

Symbol	Description	Min.	Typ.	Max.	Units
P_{RF}	Maximum output power	..	8.0	..	dBm
P_{RFC}	RF power control range		28.0		dB
P_{RFCR}	RF power accuracy			±4	dB
$P_{RF1,1}$	1st Adjacent Channel Transmit Power 1 MHz (1 Mbps)	..	-24.8	..	dBc
$P_{RF2,1}$	2nd Adjacent Channel Transmit Power 2 MHz (1 Mbps)	..	-54.0	..	dBc
$P_{RF1,2}$	1st Adjacent Channel Transmit Power 2 MHz (2 Mbps)	..	-25	..	dBc
$P_{RF2,2}$	2nd Adjacent Channel Transmit Power 4 MHz (2 Mbps)	..	-54.0	..	dBc
E_{vm}	Error vector magnitude IEEE 802.15.4	..	8	..	%rms
$P_{harm2nd, IEEE 802.15.4}$	2nd harmonics in IEEE 802.15.4 mode	..	-51.0	..	dBm
$P_{harm3rd, IEEE 802.15.4}$	3rd harmonics in IEEE 802.15.4		-48.0	..	dBm

5.3.5. RSSI Specifications

Symbol	Description	Min.	Typ.	Max.	Units
$RSSI_{ACC}$	RSSI accuracy valid range -90 to -20 dBm		±2		dB
$RSSI_{RESOLUTION}$	RSSI resolution		1		dB
$RSSI_{PERIOD}$	RSSI sampling time from $RSSI_START$ task		0.25		µs
$RSSI_{SETTLE}$	RSSI settling time after signal level change		15		µs

5.3.6. Receiver Operation

Symbol	Description	Min.	Typ.	Max.	Units
P _{RX,MAX}	Maximum received signal strength at < 0.1% PER		0		dBm
P _{SENS,IT,1M}	Sensitivity, 1 Mbps nRF mode ideal transmitter ¹		-93		dBm
P _{SENS,IT,2M}	Sensitivity, 2 Mbps nRF mode ideal transmitter ²		-89		dBm
P _{SENS,IT,SP,1M,BLE}	Sensitivity, 1 Mbps BLE ideal transmitter, packet length ≤ 37 bytes BER=1E-3 ³		-95		dBm
P _{SENS,IT,LP,1M,BLE}	Sensitivity, 1 Mbps BLE ideal transmitter, packet length ≥ 128 bytes BER=1E-4 ⁴		-94		dBm
P _{SENS,IT,SP,2M,BLE}	Sensitivity, 2 Mbps BLE ideal transmitter, packet length ≤ 37 bytes		-92		dBm
P _{SENS,IT,BLE LE125k}	Sensitivity, 125 kbps BLE mode		-103		dBm
P _{SENS,IT,BLE LE500k}	Sensitivity, 500 kbps BLE mode		-99		dBm
P _{SENS,IEEE 802.15.4}	Sensitivity in IEEE 802.15.4 mode		-100		dBm

1. Typical sensitivity applies when ADDR0 is used for receiver address correlation. When ADDR[1...7] are used for receiver address correlation, the typical sensitivity for this mode is degraded by 3 dB.
2. Same as above.
3. As defined in the Bluetooth Core Specification v4.0 Volume 6: Core System Package (Low Energy Controller Volume)
4. Equivalent BER limit < 10E-04

5.3.7. RX Selectivity

Symbol	Description	Min.	Typ.	Max.	Units
C/I _{1M,co-channel}	1Mbps mode, Co-Channel interference		9		dB
C/I _{1M,-1MHz}	1 Mbps mode, Adjacent (-1 MHz) interference		-2		dB
C/I _{1M,+1MHz}	1 Mbps mode, Adjacent (+1 MHz) interference		-10		dB
C/I _{1M,-2MHz}	1 Mbps mode, Adjacent (-2 MHz) interference		-19		dB
C/I _{1M,+2MHz}	1 Mbps mode, Adjacent (+2 MHz) interference		-42		dB
C/I _{1M,-3MHz}	1 Mbps mode, Adjacent (-3 MHz) interference		-38		dB
C/I _{1M,+3MHz}	1 Mbps mode, Adjacent (+3 MHz) interference		-48		dB
C/I _{1M,±6MHz}	1 Mbps mode, Adjacent (≥6 MHz) interference		-50		dB
C/I _{1MBLE,co-channel}	1 Mbps BLE mode, Co-Channel interference		6		dB
C/I _{1MBLE,-1MHz}	1 Mbps BLE mode, Adjacent (-1 MHz) interference		-2		dB
C/I _{1MBLE,+1MHz}	1 Mbps BLE mode, Adjacent (+1 MHz) interference		-9		dB
C/I _{1MBLE,-2MHz}	1 Mbps BLE mode, Adjacent (-2 MHz) interference		-22		dB
C/I _{1MBLE,+2MHz}	1 Mbps BLE mode, Adjacent (+2 MHz) interference		-46		dB
C/I _{1MBLE,>3MHz}	1 Mbps BLE mode, Adjacent (≥3 MHz) interference		-50		dB
C/I _{1MBLE,image}	Image frequency interference		-22		dB
C/I _{1MBLE,image,1MHz}	Adjacent (1 MHz) interference to in-band image frequency		-35		dB
C/I _{2M,co-channel}	2 Mbps mode, Co-Channel interference		10		dB

Symbol	Description	Min.	Typ.	Max.	Units
C/I _{2M,-2MHz}	2 Mbps mode, Adjacent (-2 MHz) interference		6		dB
C/I _{2M,+2MHz}	2 Mbps mode, Adjacent (+2 MHz) interference		-19		dB
C/I _{2M,-4MHz}	2 Mbps mode, Adjacent (-4 MHz) interference		-20		dB
C/I _{2M,+4MHz}	2 Mbps mode, Adjacent (+4 MHz) interference		-44		dB
C/I _{2M,-6MHz}	2 Mbps mode, Adjacent (-6 MHz) interference		-42		dB
C/I _{2M,+6MHz}	2 Mbps mode, Adjacent (+6 MHz) interference		-42		dB
C/I _{2M,≥12MHz}	2 Mbps mode, Adjacent (≥12 MHz) interference		-52		dB
C/I _{2MBLE,co-channel}	2 Mbps BLE mode, Co-Channel interference		6.8		dB
C/I _{2MBLE,±2MHz}	2 Mbps BLE mode, Adjacent (±2 MHz) interference		-10		dB
C/I _{2MBLE,±4MHz}	2 Mbps BLE mode, Adjacent (±4 MHz) interference		-45		dB
C/I _{2MBLE,≥6MHz}	2 Mbps BLE mode, Adjacent (≥6 MHz) interference		-48		dB
C/I _{2MBLE,image}	Image frequency interference		-24		dB
C/I _{2MBLE,image, 2MHz}	Adjacent (2 MHz) interference to in-band image frequency		-35		dB
C/I _{125k BLE LR, co-channel}	125 kbps BLE LR mode, Co-Channel interference		4.4		dB
C/I _{125k BLE LR,-1MHz}	125 kbps BLE LR mode, Adjacent (-1 MHz) interference		-4.0		dB
C/I _{125k BLE LR,+1MHz}	125 kbps BLE LR mode, Adjacent (+1 MHz) interference		-12		dB
C/I _{125k BLE LR,-2MHz}	125 kbps BLE LR mode, Adjacent (-2 MHz) interference		-28		dB
C/I _{125k BLE LR,+2MHz}	125 kbps BLE LR mode, Adjacent (+2 MHz) interference		-50		dB
C/I _{125k BLE LR,>3MHz}	125 kbps BLE LR mode, Adjacent (≥3 MHz) interference		-55		dB
C/I _{125k BLE LR,image}	Image frequency interference		-29		dB

Remark: Wanted signal level at PIN = -67 dBm. One interferer is used, having equal modulation as the wanted signal. The input power of the interferer where the sensitivity equals BER = 0.1% is presented.

5.3.8. RX Intermodulation

Symbol	Description	Min.	Typ.	Max.	Units
P _{IMD,5TH,1M}	IMD performance, 1 Msps, 5th offset channel, Packet length ≤ 37 bytes		-33		dBm
P _{IMD,5TH,1M,BLE}	IMD performance, BLE 1 Msps, 5th offset channel, Packet length ≤ 37 bytes		-30		dBm
P _{IMD,5TH,2M}	IMD performance, 2 Msps, 5th offset channel, Packet length ≤ 37 bytes		-33		dBm
P _{IMD,5TH,2M,BLE}	IMD performance, BLE 2 Msps, 5th offset channel, Packet length ≤ 37 bytes		-31		dBm

Remark: Wanted signal level at PIN = -64dBm. Two interferers with equal input power are used. The interferer closest in frequency is not modulated, the other interferer is modulated equal with the wanted signal. The input power of the interferers where the sensitivity equals BER = 0.1% is presented.

5.3.9. Radio Timing Parameters

Symbol	Description	Min.	Typ.	Max.	Units
$t_{TXEN,BLE,1M}$	Time between TXEN task and READY event after channel FREQUENCY configured (1 Mbps BLE and 150 μ s TIFS)	140		140	μ s
$t_{TXEN,FAST,BLE,1M}$	Time between TXEN task and READY event after channel FREQUENCY configured (1 Mbps BLE with fast ramp-up and 150 μ s TIFS)	40		40	μ s
$t_{TXDIS,BLE,1M}$	When in TX, delay between DISABLE task and DISABLED event for MODE = Nrf_1Mbit and MODE = Ble_1Mbit	6		6	μ s
$t_{RXEN,BLE,1M}$	Time between the RXEN task and READY event after channel FREQUENCY configured (1 Mbps BLE)	140		140	μ s
$t_{RXEN,FAST,BLE,1M}$	Time between the RXEN task and READY event after channel FREQUENCY configured (1 Mbps BLE with fast ramp-up)	40		40	μ s
$t_{RXDIS,BLE,1M}$	When in RX, delay between DISABLE task and DISABLED event for MODE = Nrf_1Mbit and MODE = Ble_1Mbit	0		0	μ s
$t_{TXDIS,BLE,2M}$	When in TX, delay between DISABLE task and DISABLED event for MODE = Nrf_2Mbit and MODE = Ble_2Mbit	4		4	μ s
$t_{RXDIS,BLE,2M}$	When in RX, delay between DISABLE task and DISABLED event for MODE = Nrf_2Mbit and MODE = Ble_2Mbit	0		0	μ s
$t_{TXEN,IEEE\ 802.15.4}$	Time between TXEN task and READY event after channel FREQUENCY configured (IEEE 802.15.4)	130		130	μ s
$t_{TXEN,FAST,IEEE\ 802.15.4}$	Time between TXEN task and READY event after channel FREQUENCY configured (IEEE 802.15.4 with fast ramp-up)	40		40	μ s
$t_{TXDIS,IEEE\ 802.15.4}$	When in TX, delay between DISABLE task and DISABLED event (IEEE 802.15.4)	21		21	μ s
$t_{RXEN,IEEE\ 802.15.4}$	Time between the RXEN task and READY event after channel FREQUENCY configured (IEEE 802.15.4)	130		130	μ s
$t_{RXEN,FAST,IEEE\ 802.15.4}$	Time between the RXEN task and READY event after channel FREQUENCY configured (IEEE 802.15.4 with fast ramp-up)	40		40	μ s
$t_{RXDIS,IEEE\ 802.15.4}$	When in RX, delay between DISABLE task and DISABLED event (IEEE 802.15.4)	0.5		0.5	μ s
$t_{RX\text{-to-TX}\ \text{turnaround}}$	Maximum TX-to-RX or RX-to-TX turnaround time in IEEE 802.15.4 mode		40		μ s

5.3.10. CPU

Symbol	Description	Min.	Typ.	Max.	Units
W _{FLASH}	CPU wait states, running CoreMark from flash, cache disabled			2	
W _{FLASHCACHE}	CPU wait states, running CoreMark from flash, cache enabled			3	
W _{RAM}	CPU wait states, running CoreMark from RAM			0	
CM _{FLASH}	CoreMark, running CoreMark from flash, cache enabled		212		Coref
CM _{FLASH/MHz}	CoreMark per MHz, running CoreMark from flash, cache enabled		3.3		CoreMark/ MHz
CM _{FLASH/mA}	CoreMark per mA, running CoreMark from flash, cache enabled, DCDC 3V		59		Coref mA

5.3.11. Power Management

Symbol	Description	Min.	Typ.	Max.	Units
I _{ON_RAMOFF_EVENT}	System ON, no RAM retention, wake on any event		0.97		μA
I _{ON_RAMON_EVENT}	System ON, full 256 kB RAM retention, wake on any event		2.35		μA
I _{ON_RAMON_POF}	System ON, full 256 kB RAM retention, wake on any event, power-fail comparator enabled		2.35		μA
I _{ON_RAMON_GPIOTE}	System ON, full 256 kB RAM retention, wake on GPIOTE input (event mode)		17.37		μA
I _{ON_RAMON_GPIOTEPORT}	System ON, full 256 kB RAM retention, wake on GPIOTE PORT event		2.36		μA
I _{ON_RAMOFF_RTC}	System ON, no RAM retention, wake on RTC (running from LFRC clock)		1.5		μA
I _{ON_RAMON_RTC}	System ON, full 256 kB RAM retention, wake on RTC (running from LFRC clock)		3.16		μA
I _{OFF_RAMOFF_RESET}	System OFF, no RAM retention, wake on reset		0.40		μA
I _{OFF_RAMOFF_LPCOMP}	System OFF, no RAM retention, wake on LPCOMP		0.86		μA
I _{OFF_RAMON_RESET}	System OFF, full 256 kB RAM retention, wake on reset		1.86		μA
I _{ON_RAMOFF_EVENT_5V}	System ON, no RAM retention, wake on any event, 5 V supply on VDDH, REG0 output = 3.3 V		1.29		μA
I _{OFF_RAMOFF_RESET_5V}	System OFF, no RAM retention, wake on reset, 5 V supply on VDDH, REG0 output = 3.3 V		0.95		μA

6. Block Diagram

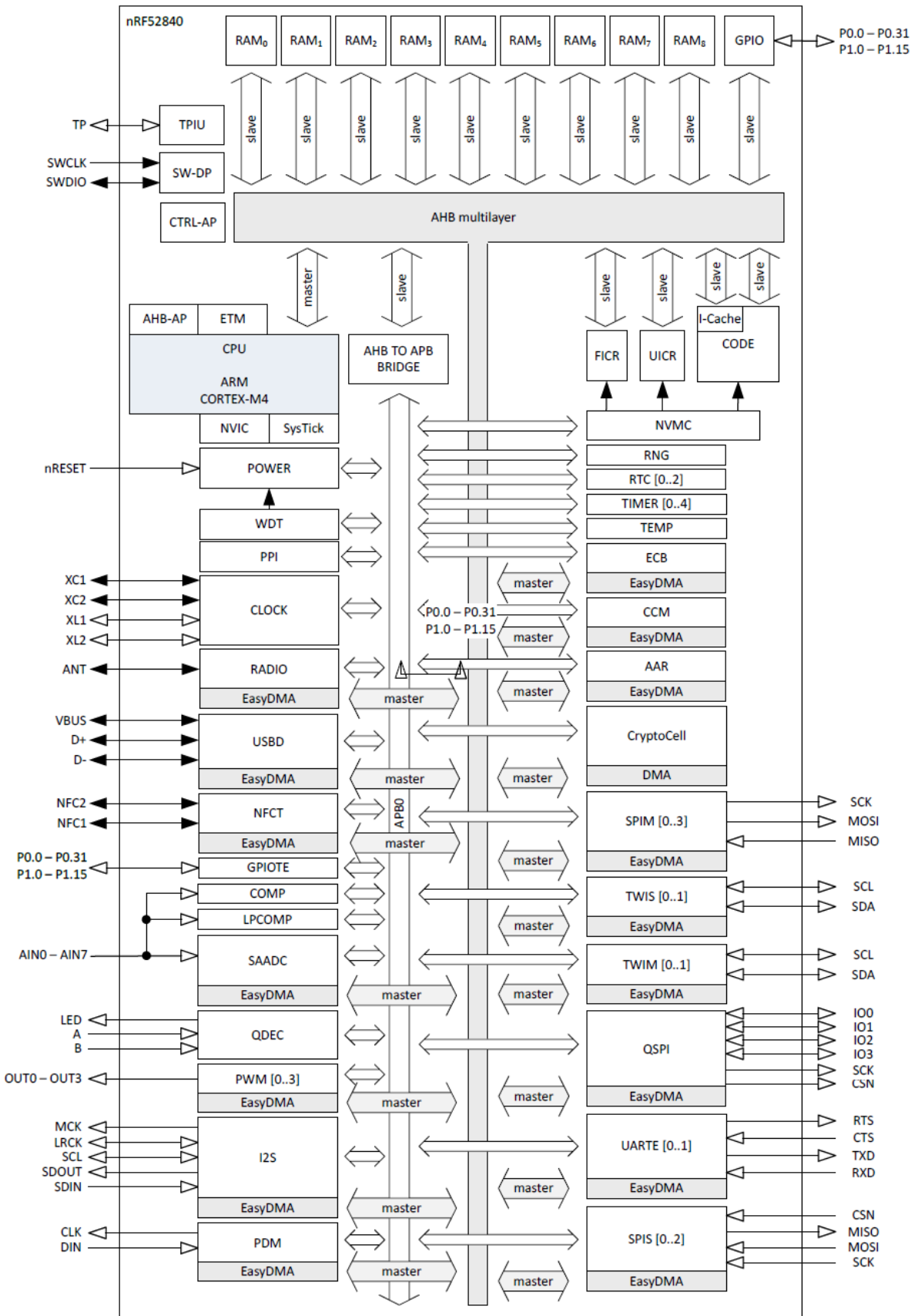

7. Antenna

7.1. MDBT50Q

Antenna Gain and Efficiency

MDBT50Q (CHIP antenna)			
Freq(MHz)	Peak. dBi	Efficiency	Average . dBi
2400.00	-1.47	25.18%	-5.99
2410.00	-1.27	26.07%	-5.84
2420.00	-1.32	27.15%	-5.66
2430.00	-1.12	28.51%	-5.45
2440.00	-0.80	29.41%	-5.32
2450.00	-0.65	29.59%	-5.29
2460.00	-0.82	28.98%	-5.38
2470.00	-0.94	29.31%	-5.33
2480.00	-0.88	29.12%	-5.36
2490.00	-0.98	27.60%	-5.59
2500.00	-1.49	24.96%	-6.03

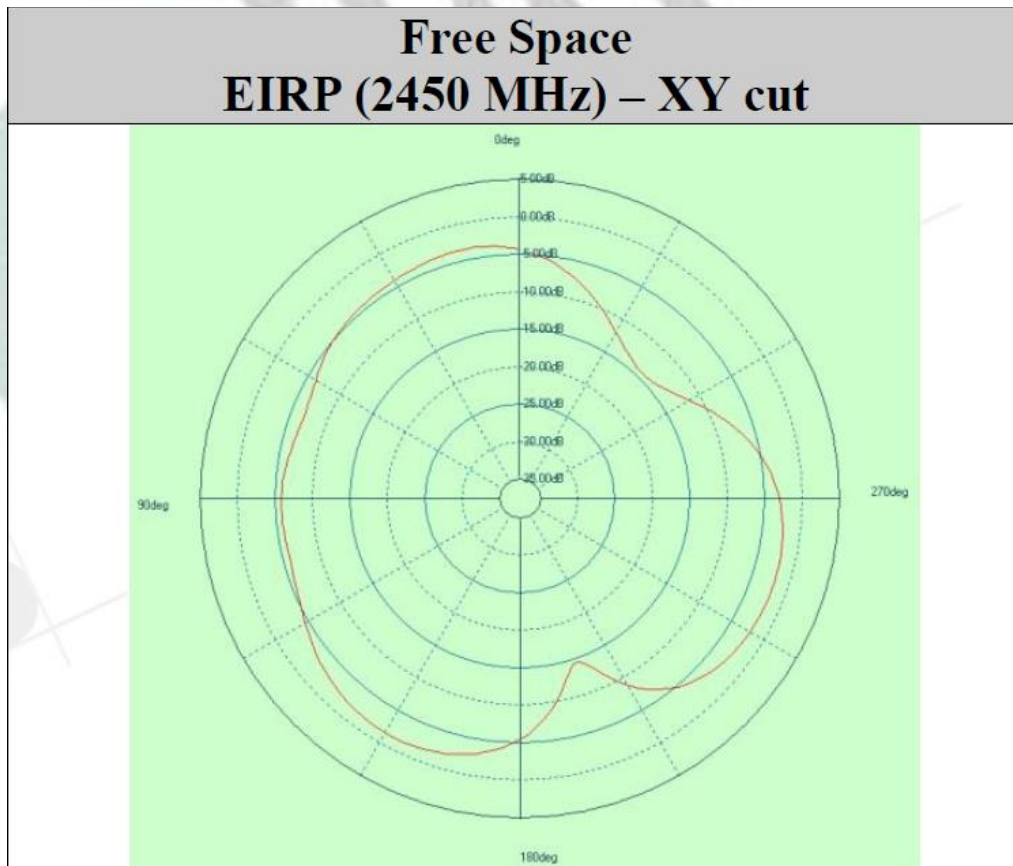

Free Space EIRP (2450 MHz) – XZ cut

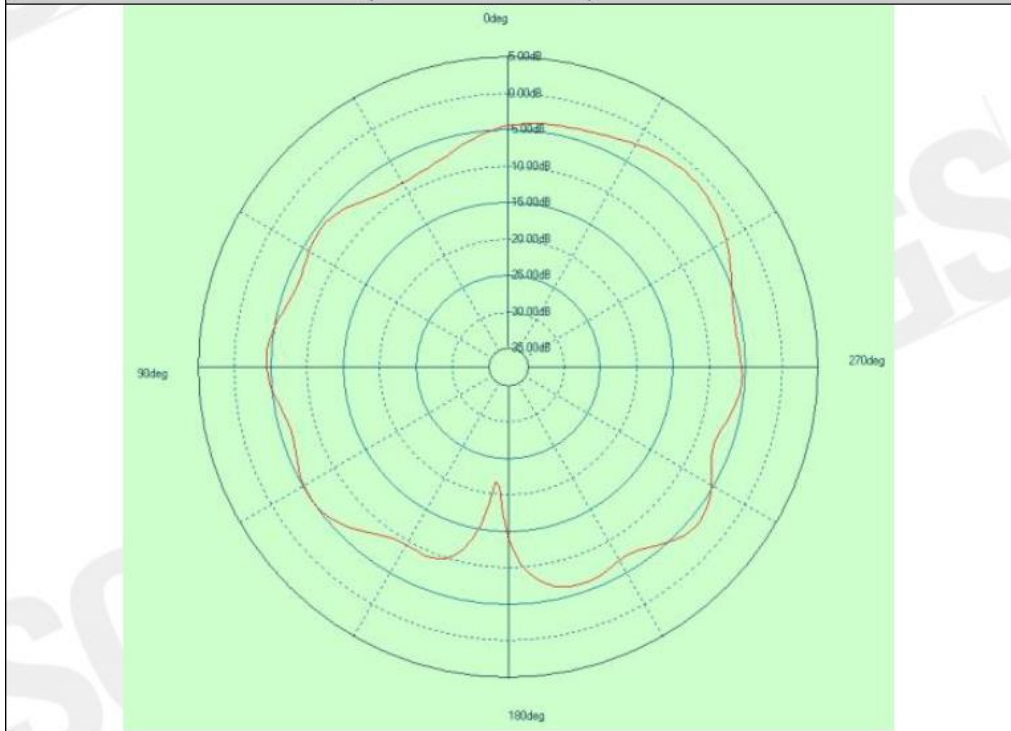

Free Space EIRP (2450 MHz) – YZ cut

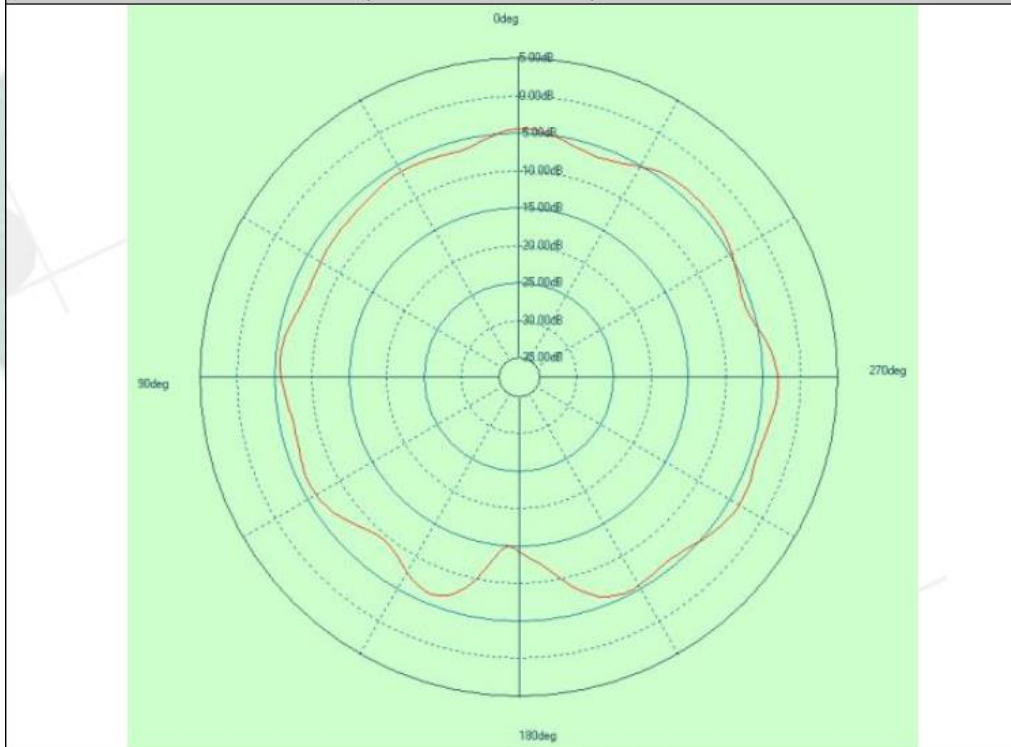

7.2. MDBT50Q-P

Antenna Gain and Efficiency

MDBT50Q (PCB antenna)			
Freq(MHz)	Peak. dBi	Efficiency	Average . dBi
2400.00	-0.72	29.40%	-5.32
2410.00	-0.62	31.02%	-5.08
2420.00	-0.44	32.89%	-4.83
2430.00	-0.44	35.00%	-4.56
2440.00	0.08	36.98%	-4.32
2450.00	0.05	37.76%	-4.23
2460.00	0.24	37.40%	-4.27
2470.00	0.26	37.43%	-4.27
2480.00	0.41	36.96%	-4.32
2490.00	0.37	35.03%	-4.56
2500.00	-0.15	31.71%	-4.99

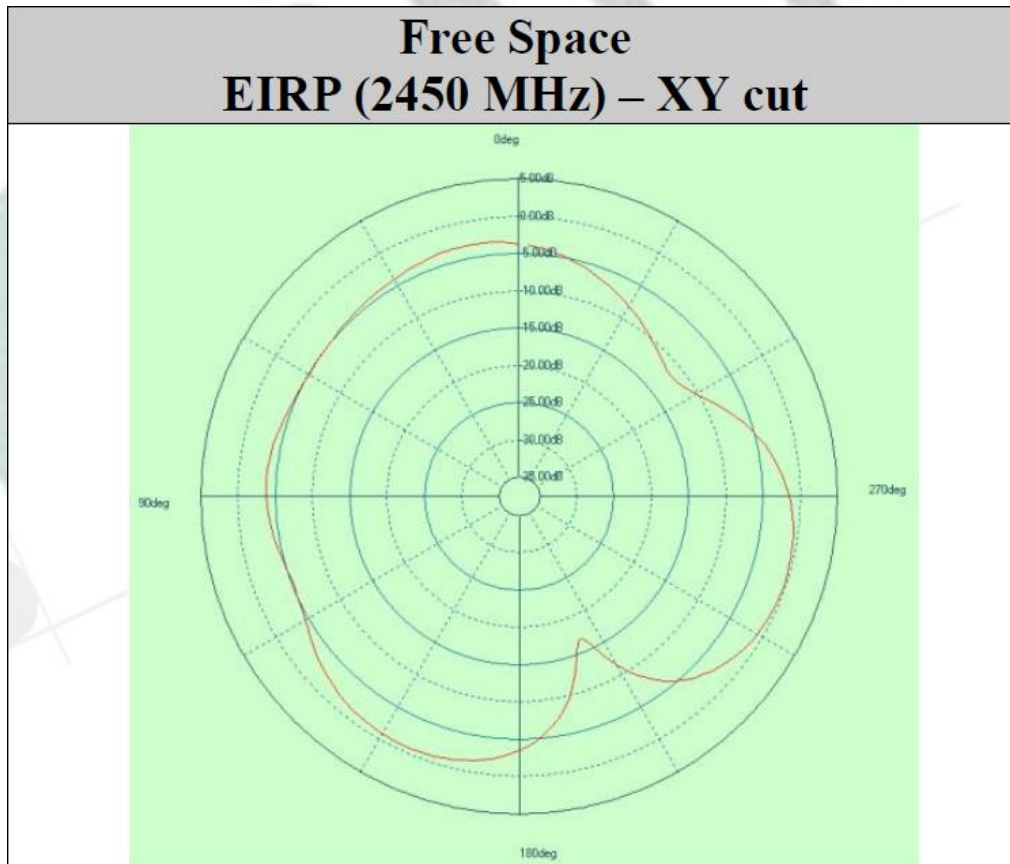

Free Space EIRP (2450 MHz) – XZ cut

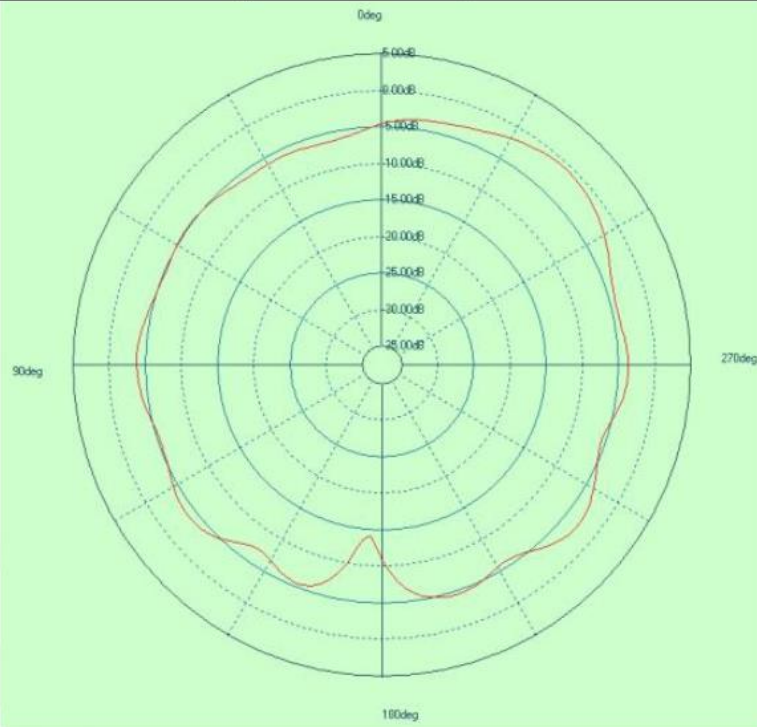

Free Space EIRP (2450 MHz) – YZ cut

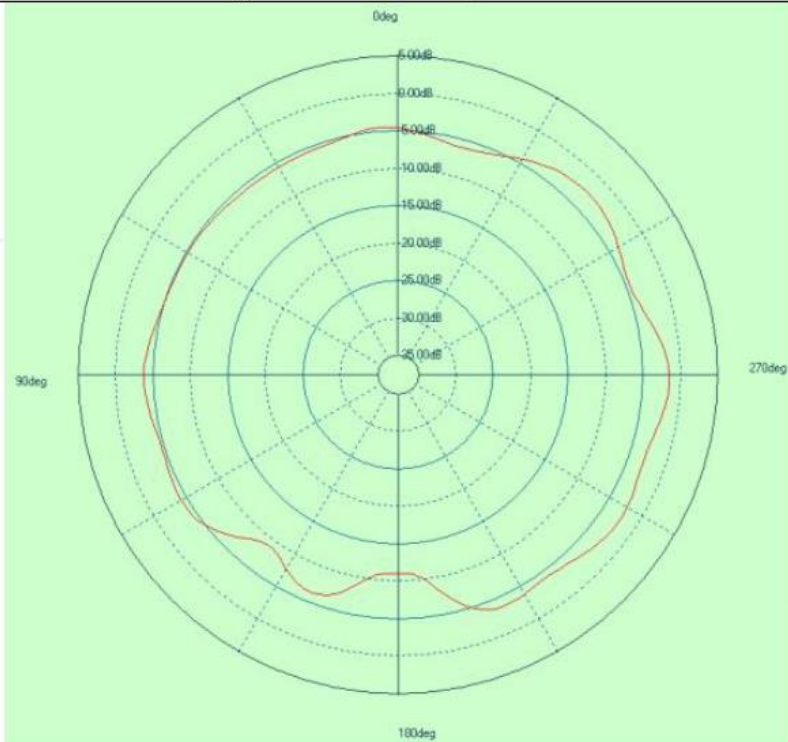

8. Reference Circuit

This chapter shows a different combination of reference circuits. **Before getting started, please read below notes carefully because it is applied to all the reference circuits.**

- 32MHz crystal and RF (VDD) DC/DC inductor (Reg1) are already inside the module.
- Module is pre-programmed with Raytac testing code. Default is using DC-DC mode and need to add external 32.768khz to work.

You can use DC-DC mode *without* adding external 32.768khz, they are **NOT** related events.

- When using internal 32.768khz RC oscillator, please remove X2 / C12 / C13.
- Recommended L4 spec: 10 μ H, 0603 Chip Inductor, IDC, min = 80mA, \pm 20%.
- When **NOT** using NFC, please remove NFC1 / C19 / C21.

8.1. Reg0 DC/DC Enabled

Recommend using when *the highest* input voltage is equal or greater than 3.6V. Supply power from VCC2 (VDDH).

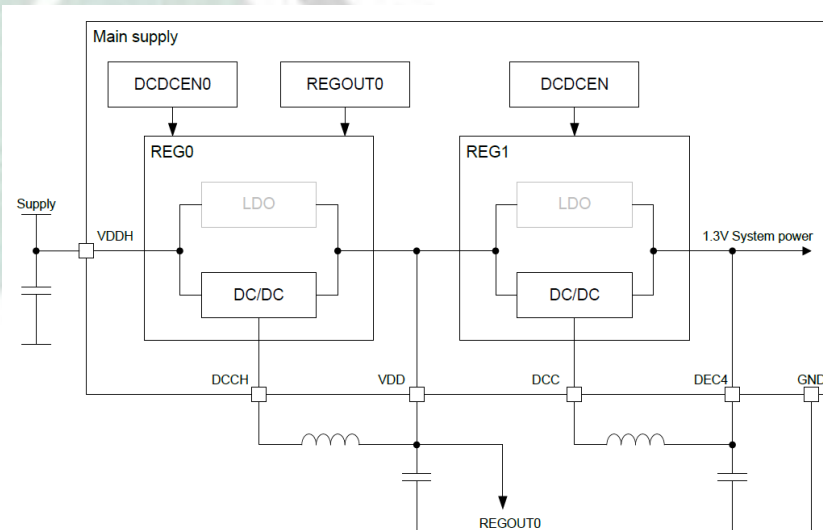
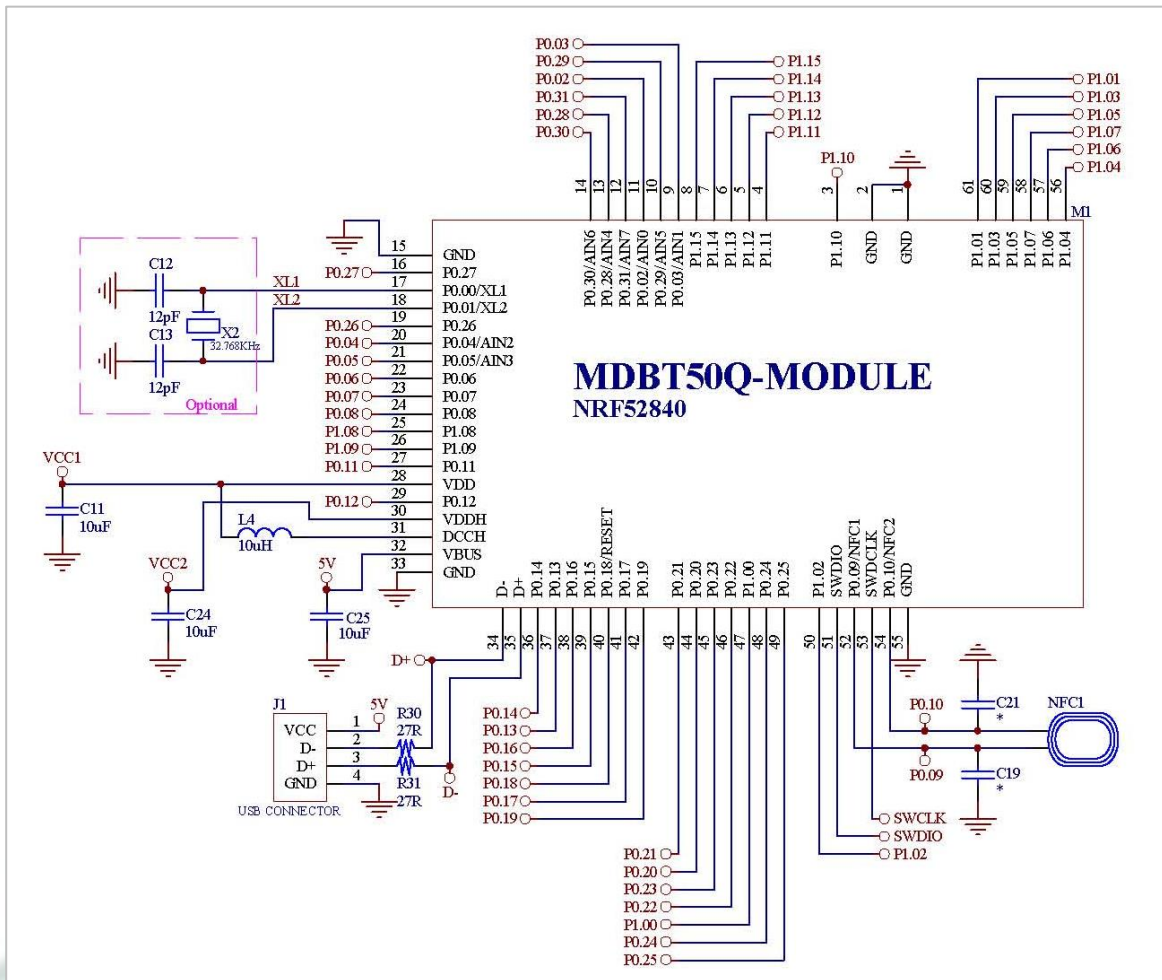

Please check "[Nordic PCN111 Product Change Notification v1.0](#)" for more details about this reference circuit.

8.3. Reg0 DC/DC and LDO Mode Disabled

Recommend using when *the highest* input voltage is less than 3.6V.

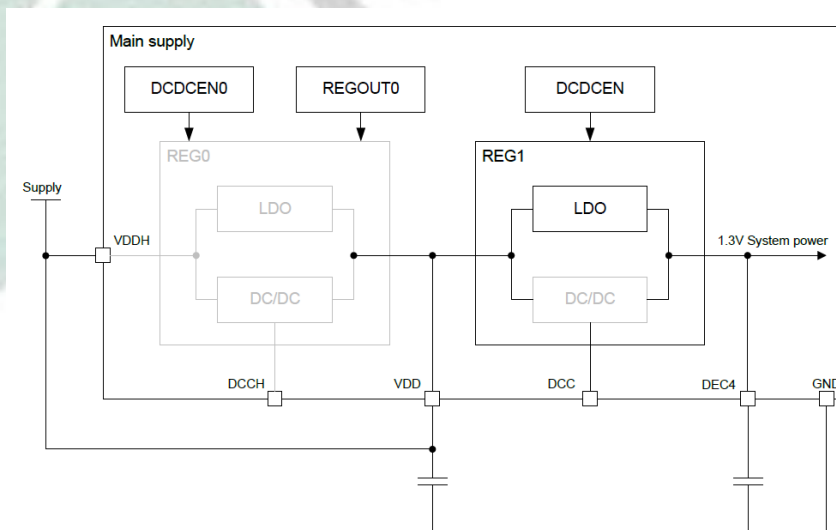
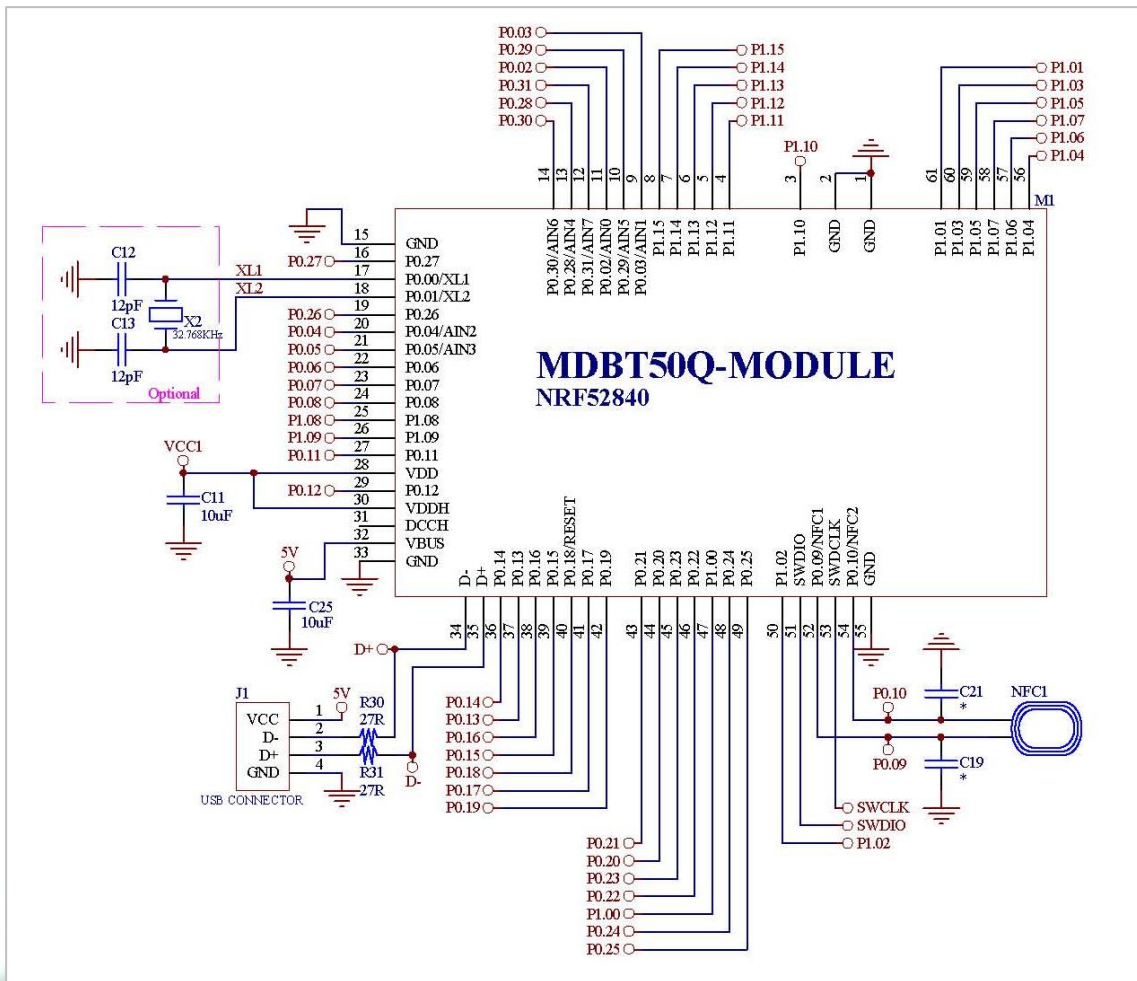

9. Certification

9.1. Declaration ID

Declaration ID	QDID(s)	Company	Specification Name
D041673	118335 - End Product 91659 - Profile Subsystem 111537 - Profile Subsystem	Raytac Corporation	5.0

Supported profile and service:

Profile Description	Service Description
Alert Notification Profile	Alert Notification Service
Blood Pressure Profile	Blood Pressure Service
	Device Information Service
Cycling Speed & Cadence Profile	Cycling Speed & Cadence Service
	Device Information Service
Glucose Profile	Glucose Service
	Device Information Service
Health Thermometer Profile	Health Thermometer Service
	Device Information Service
Heart Rate Profile	Heart Rate Service
	Device Information Service
HID over GATT Profile	HID Service
	Battery Service
Proximity Profile	Link Loss Service
	Immediate Alert Service
	TX Power Service
Running Speed & Cadence Profile	Running Speed & Cadence Service
	Device Information Service
Time Profile	Time Profile Service
Glucose Profile (Central)	
Mesh Profile	Mesh Provisioning Service
	Mesh Proxy Service

9.2. FCC Certificate (USA)

BLE 5.0 and IEEE 802.15.4 approved.



TCB

**GRANT OF EQUIPMENT
AUTHORIZATION**

Certification
Issued Under the Authority of the
Federal Communications Commission

By:

Telefication B.V.
Edisonstraat 12a
Zevenaar, NL-6902 PK
Netherlands

TCB

Date of Grant: 07/26/2018

Application
Dated: 07/25/2018

Raytac Corp.
5F., No.3, Jiankang Rd., Zhonghe Dist.,
New Taipei City,, 23586
Taiwan

Attention: Venson Liao , R&D Manager

NOT TRANSFERABLE

EQUIPMENT AUTHORIZATION is hereby issued to the named
GRANTEE, and is VALID ONLY for the equipment identified hereon for
use under the Commission's Rules and Regulations listed below.

FCC IDENTIFIER: SH6MDBT50Q

Name of Grantee: Raytac Corp.

Equipment Class: Digital Transmission System

Notes: Bluetooth Low Energy & IEEE 802.15.4 Combo Module

Modular Type: Single Modular





Grant Notes	FCC Rule Parts	Frequency Range (MHZ)	Output Watts	Frequency Emission Tolerance Designator
	15C	2402.0 - 2480.0	0.0066	
	15C	2405.0 - 2480.0	0.0066	

Modular Approval. This is a portable device. Power Output is conducted. This grant is valid only when the module is sold to OEM integrators and must be installed by the OEM or OEM integrators. End-users may not be provided with the module installation instructions. OEM integrators and end-users must be provided with transmitter operating conditions for satisfying RF exposure compliance.

<p>Certificate No.: 182180940/AA/00</p>	<p>Ramy Nabod Product Assessor</p>	
---	--	--

9.3. TELEC Certificate (Japan)

BLE 5.0

	<i>Certificate Technical Support Center Co.,Ltd.</i> <i>RAB ID No. 018</i>
Construction Type Certification	
Registration No.	CSRT180280
Certificate Holder	Raytac Corporation 5F, No.3, Jiankang Rd., Zhonghe Dist., New Taipei City, 235, Taiwan
Product Category	Article 2, Paragraph 1, Item 19
Model Type or Name	MDBT50Q, MDBT50Q-1M, MDBT50Q-P1M, MDBT50Q-U1M
Type of Emission, Frequency and Antenna Power	F1D 2402MHz - 2480MHz (2MHz separation, 40 channels) 5.9704mW, 5.0816mW
Manufacturer	Raytac Corporation 5F, No.3, Jiankang Rd., Zhonghe Dist., New Taipei City, 235, Taiwan
Factory	Tech-Lin's Electronics Corp. 5F/11F, No. 778, Zhongzheng Rd., Zhonghe Dist., New Taipei City 23586, Taiwan R.O.C
Remarks	The scope of evaluation relates to the submitted documents and product only. It is only valid in conjunction with the Annex.
When the product is placed on the Japanese market, the Specified Radio Equipment marking as shown on the right must be attached on visible part of the product.	 R 018-180280
Witnesses that the certification is on Construction Type Certification under Article 38-24 of the Radio Law.	
Date of Certificate 2018/7/30	 Certification Examiner : Takuji Nakano  Certificate Technical Support Center Co., Ltd.
	
Address: Shinyokohama First Bldg B1, 1-2-1 Shinyokohama, Kohoku-ku, Yokohama-City, 222-0033 Japan Tel.: +81 45 478 3365 • Fax: +81 45 478 3382 • E-mail: cert@cns-web.co.jp	

IEEE 802.15.4



Certificate Technical Support Center Co.,Ltd.
RAB ID No. 018

Construction Type Certification

Registration No.	CSRT180280
Certificate Holder	Raytac Corporation 5F, No.3, Jiankang Rd., Zhonghe Dist., New Taipei City, 235, Taiwan
Product Category	Article 2, Paragraph 1, Item 19
Model Type or Name	MDBT50Q, MDBT50Q-1M, MDBT50Q-P1M, MDBT50Q-U1M
Type of Emission, Frequency and Antenna Power	G1D 2405MHz - 2480MHz (5MHz separation, 16 channels) 3.539mW/MHz
Manufacturer	Raytac Corporation 5F, No.3, Jiankang Rd., Zhonghe Dist., New Taipei City, 235, Taiwan
Factory	Tech-Lin's Electronics Corp. 5F/11F, No. 778, Zhongzheng Rd., Zhonghe Dist., New Taipei City 23586, Taiwan R.O.C
Remarks	The scope of evaluation relates to the submitted documents and product only. It is only valid in conjunction with the Annex.

When the product is placed on the Japanese market, the Specified Radio Equipment marking as shown on the right must be attached on visible part of the product.



R 018-180280

Witnesses that the certification is on Construction Type Certification under Article 38-24 of the Radio Law.

Date of Certificate
2018/7/30

Takuji Nakano

Certification Examiner : Takuji Nakano
C&S Certificate Technical Support Center Co., Ltd.



Address: Shinyokohama First Bldg B1, 1-2-1 Shinyokohama, Kohoku-ku, Yokohama-City, 222-0033 Japan
Tel.: +81 45 478 3365 • Fax: +81 45 478 3382 • E-mail: cert@cns-web.co.jp

9.4. NCC Certificate (Taiwan)

BLE 5.0 and IEEE 802.15.4 approved.

MDBT50Q

	台灣檢驗科技股份有限公司 電信管制射頻器材型式認證證明
一、申請者：	勁達國際電子有限公司
二、地址：	235 新北市中和區建康路 3 號 5 樓
三、製造廠商：	勁達國際電子有限公司
四、器材名稱：	低功耗藍牙及 IEEE 802.15.4 整合模組
五、廠牌：	Raytac
六、型號：	MDBT50Q-1M
七、發射功率 (電場強度)：	BT V5.0 single mode LE (GFSK): 8.19dBm (Peak) BT single mode LE (GFSK): 8.03dBm (Peak) Zigbee(O-QPSK): 8.18dBm (Peak)
八、工作頻率：	BT V5.0 single mode LE (GFSK): 2402-2480MHz Zigbee(O-QPSK): 2405-2480MHz
九、審驗日期：	107 年 7 月 30 日
十、審驗合格標籤式樣：	
十一、警語或標示要求：	<p>1. 應依審驗合格標籤或符合性聲明標籤式樣自製標籤貼於或印鑄於電信管制射頻器材本體明顯處，並於包裝盒標示本會標章，始得開陳列或販售。</p> <p>2. 電信管制射頻器材應依本會或相關技術規範規定於指定位置標示中文警語。</p> <p>3. 總授權使用射頻模組(組件)之審驗合格標籤者，應於最終產品說明書及包裝盒提供充分與正確之資訊。</p> <p>4. 於網際網路販售取得審驗證明之電信管制射頻器材者，應於該網際網路網頁提供審驗合格標籤或符合性聲明標籤資訊。</p> <p>5. 使用手冊應標示下列資訊： (1) 組型式認證合格之低功耗射頻電機，非經許可，公司、商號或使用者均不得擅自變更頻率、加大功率或變更原設計之特性及功能。低功耗射頻電機之使用不得影響飛航安全及干擾合法通信；經發現有干擾現象時，應立即停用，並改善至無干擾時方得繼續使用。前項合法通信，指依電信法規定作業之無線電通信。低功耗射頻電機須忍受合法通信或工業、科學及醫療用電波輻射性電機設備之干擾。</p>
十二、特殊記載事項：	<p>1. 經取得審驗證明之電信管制射頻器材，如變更其廠牌、型號、技術規格或射頻性能時，除電信管制射頻器材審驗辦法另有規定外，應重新申請審驗。</p> <p>2. 經取得審驗證明之電信管制射頻器材或射頻模組(組件)於電信管制射頻器材相關技術規範修訂審驗相關章節時，應依下列規定辦理： (1) 修訂後之技術規範明定實施期限者，依實施期限，申請重新審驗。 (2) 修訂後之技術規範未明定實施期限者，應於技術規範修訂後二年內，申請重新審驗。經取得審驗證明之電信管制射頻器材，於電信管制射頻器材相關技術規範修訂審驗相關章節時，修訂後之技術規範未明定實施期限者，應於技術規範修訂後二年內，申請重新審驗。未依規定重新審驗者，原驗證機關(構)得廢止其審驗證明。</p> <p>3. 取得型式認證證明、符合性聲明證明及簡易符合性聲明證明者，應妥善保管申請審驗器材樣品、測試所需之特殊測試軟體及特殊治具至該器材停止生產或停止輸入後五年。</p> <p>4. 取得型式認證證明或符合性聲明證明者授權他人於同廠牌同型號之電信管制射頻器材或射頻模組(組件)使用審驗合格標籤或符合性聲明標籤，應由取得審驗證明者於本會指定位置登錄。</p> <p>5. 以取得審驗證明之射頻模組(組件)組裝於最終產品後，取得審驗證明者，應於該最終產品輸入、販售或公開陳列前，檢具標註最終產品廠牌、型號及外觀照片之電子檔，向原驗證機關(構)登錄；以射頻模組(組件)取得審驗證明者，授權他人使用其審驗合格標籤，該射頻模組(組件)組裝於最終產品後，取得審驗證明者應檢具標註最終產品廠牌、型號及外觀照片之電子檔，向原驗證機關(構)登錄。</p> <p>6. 本案審驗模組為完全模組，適用於任何平臺。</p> <p>7. 「平臺」指不組裝射頻模組(組件)，仍具備該平臺主要功能之器材。</p>
說明：	<p>1. 本公司/中心係經國家通訊傳播委員會委託之驗證機構(證書號碼：NCC-RCB-13，機構地址：新北市五股區新北產業園區五工路 134 號，電話：02-2299 3279)，核發本型式認證證明。</p> <p>2. 請依上列標籤式樣自製標籤，標貼或印鑄於器材本體明顯處，始得販售或公開陳列。</p> <p>3. 本設備之製造、輸入、販售、使用等均需遵守相關電信法規之規定。</p>
備註：	<p>1. 本器材符合低功耗射頻電機技術規範(3.10.1)之規定。</p> <p>2. 本公司僅對無線射頻特性技術規範辦理型式認證，其他仍須依本國相關法規辦理。</p> <p>3. 本器材使用天線型號： Chip Antenna，天線廠牌：Raytac，Model No.：MDBT50Q，增益：-0.65dBi。</p> <p>4. 本公司係經國家通訊傳播委員會委託之驗證機構，核發本型式認證證明。</p>

MDBT50Q-P

SGS

台灣檢驗科技股份有限公司 電信管制射頻器材型式認證證明

- 一、申請者：勁達國際電子有限公司
二、地址：235 新北市中和區建康路 3 號 5 樓
三、製造廠商：勁達國際電子有限公司
四、器材名稱：低功耗藍牙及 IEEE 802.15.4 整合模組
五、廠牌：Raytac
六、型號：MDBT50Q-P1M
七、發射功率 (電場強度)：BT V5.0 single mode LE (GFSK): 8.19dBm (Peak)
BT single mode LE (GFSK): 8.03dBm (Peak)
Zigbee(O-QPSK): 8.18dBm (Peak)
八、工作頻率：BT V5.0 single mode LE (GFSK): 2402-2480MHz
Zigbee(O-QPSK): 2405-2480MHz

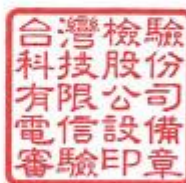

九、審驗日期：107 年 7 月 30 日

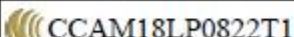
十、審驗合格標籤式樣：

十一、警語或標示要求：

- 應依審驗合格標籤或符合性聲明標籤式樣自製標籤黏貼或印鑄於電信管制射頻器材本體明顯處，並於包裝盒標示本會標章，始得開陳列或販賣。
- 電信管制射頻器材應依本會或相關技術規範規定於指定位置標示中文警語。
- 經授權使用射頻模組(組件)之審驗合格標籤者，應於最終產品說明書及包裝盒提供充分與正確之資訊。
- 於網際網路販賣取得審驗證明之電信管制射頻器材者，應於該網際網路網頁提供審驗合格標籤或符合性聲明標籤資訊。
- 使用時應標示下列資訊：
(1)經型式認證合格之低功耗射頻電機，非經許可，公司、商號或使用者均不得擅自變更頻率、加大功率或變更原設計之特性及功能。低功耗射頻電機之使用不得影響飛航安全及干擾合法通信；經發現有干擾現象時，應立即停用，並改善至無干擾時方得繼續使用。前項合法通信，指依電信法規定作業之無線電通信。低功耗射頻電機須忍受合法通信或工業、科學及醫療用電波輻射性電機設備之干擾。

十二、特殊記載事項：

- 經取得審驗證明之電信管制射頻器材，如變更其廠牌、型號、技術規格或射頻性能時，除電信管制射頻器材審驗辦法另有規定外，應重新申請審驗。
- 經取得審驗證明之電信管制射頻器材或射頻模組(組件)，於電信管制射頻器材相關技術規範修訂審驗相關章節時，應依下列規定辦理：
(1)修訂後之技術規範未定實施期限者，依實施期限，申請重新審驗。
(2)修訂後之技術規範未定實施期限者，應於技術規範修訂後二年內，申請重新審驗。經取得審驗證明之電信管制射頻器材，於電信管制射頻器材相關技術規範修訂審驗相關章節時，修訂後之技術規範未定實施期限者，應於技術規範修訂後二年內，申請重新審驗。未依規定重新審驗者，原驗證機關(構)得廢止其審驗證明。
- 取得型式認證證明、符合性聲明證明及簡易符合性聲明證明者，應妥善保管申請審驗器材樣品、測試所需之特殊測試軟體及特殊治具至該器材停止生產或停止輸入後五年。
- 取得型式認證證明或符合性聲明證明者授權他人於同廠牌同型號之電信管制射頻器材或射頻模組(組件)使用審驗合格標籤或符合性聲明標籤，應由取得審驗證明者於本會指定位置登錄。
- 以取得審驗證明之射頻模組(組件)組裝於最終產品後，取得審驗證明者，應於該最終產品輸入、販賣或公開陳列前，檢具標籤最終產品廠牌、型號及外觀照片之電子檔，向原驗證機關(構)登錄；以射頻模組(組件)取得審驗證明者，授權他人使用其審驗合格標籤，該射頻模組(組件)組裝於最終產品後，取得審驗證明者應檢具標籤最終產品廠牌、型號及外觀照片之電子檔，向原驗證機關(構)登錄。
- 本案審驗模組為完全模組，適用於任何平臺。
- 「平臺」指不組裝射頻模組(組件)，仍具備該平臺主要功能之器材。

說明：

- 本公司/中心係經國家通訊傳播委員會委託之驗證機構(證書號碼：NCC-RCB-13、機構地址：新北市五股區新北產業園區五工路 134 號、電話：02-2299 3279)，核發本型式認證證明。
- 請依上列標籤式樣自製標籤，標貼或印鑄於器材本體明顯處，始得販賣或公開陳列。
- 本設備之製造、輸入、販賣、使用等均需遵守相關電信法規之規定。

備註：

- 本器材符合低功耗射頻電機技術規範(3.10.1)之規定。
- 本公司僅對無線射頻特性技術規範辦理型式認證，其他仍須依本國相關法規辦理。
- 本器材使用天線型號：
PCB Antenna，天線廠牌：Raytac，Model No.: MDBT50Q-P，增益：0.41dBi。
- 本公司係經國家通訊傳播委員會委託之驗證機構，核發本型式認證證明。

9.5. CE (EU) & RCM (Australia & New Zealand) Test Report

BLE 5.0

	Report No.: E2/2018/50088 Page: 1 of 71
RED (2014/53/EU) ETSI EN 300 328 V2.1.1: 2016 & Australian/New Zealand Standard AS/NZS 4268:2017 TEST REPORT	
FOR	
Applicant:	Raytac Corporation 5F, No.3, Jiankang Rd., Zhonghe Dist., New Taipei City, 235, Taiwan
Product Name:	Bluetooth Low Energy & IEEE 802.15.4 Combo Module
Brand Name:	Raytac
Model No.:	MDBT50Q, MDBT50Q-1M, MDBT50Q-P1M, MDBT50Q-U1M
Model Difference:	Different Antenna Type
Report Number:	E2/2018/5088
Issue Date:	Jul. 05, 2018
Date of Test:	May 31, 2018 ~ Jun. 28, 2018
Date of EUT Received:	May 31, 2018
We hereby certify that: The above equipment was tested by SGS Taiwan Ltd., Electronics & Communication Laboratory for compliance with the requirements set forth in the European Standard ETSI EN 300 328 V2.1.1: 2016 under RED 2014/53/EU and Australian/New Zealand Standard AS/NZS 4268:2017, Row 59. Test report to determine compliance with AS/NZS 4268 requirements. The results of testing in this report apply to the product system that was tested only. Other similar equipment will not necessarily produce the same results due to production tolerance and measurement uncertainties.	
Tested By:	 _____ Vito Pei / Sr. Engineer
Approved By:	 _____ Jim Chang / Asst. Manager
	  Testing Laboratory 0513



**RED (2014/53/EU) ETSI EN 300 328 V2.1.1: 2016
&
Australian/New Zealand Standard AS/NZS 4268:2017
TEST REPORT**

FOR

Applicant: Raytac Corporation
5F, No.3, Jiankang Rd., Zhonghe Dist., New Taipei City, 235,
Taiwan

Product Name: Bluetooth Low Energy & IEEE 802.15.4 Combo Module

Brand Name: Raytac

Model No.: MDBT50Q, MDBT50Q-1M, MDBT50Q-P1M,
MDBT50Q-U1M

Model Difference: Different Antenna Type

Report Number: E2/2018/50089

Issue Date: Jul. 25, 2018

Date of Test: May 31, 2018 ~ Jul. 23, 2018

Date of EUT Received: May 31, 2018

We hereby certify that:

The above equipment was tested by SGS Taiwan Ltd., Electronics & Communication Laboratory for compliance with the requirements set forth in the European Standard ETSI EN 300 328 V2.1.1: 2016 under RED 2014/53/EU and Australian/New Zealand Standard AS/NZS 4268:2017. Test report to determine compliance with AS/NZS 4268 requirements. The results of testing in this report apply to the product system that was tested only. Other similar equipment will not necessarily produce the same results due to production tolerance and measurement uncertainties.

Tested By:

Vito Pei

Vito Pei / Sr. Engineer

Approved By:

Jim Chang

Jim Chang / Manager



Testing Laboratory
0913



SGS Reference No: MH/2018/60113C

VERIFICATION OF EMC COMPLIANCE

Verification No. : MH/2018/60113C
Representative Model No. : MDBT50Q
Added Model(s) : MDBT50Q-1M, MDBT50Q-P1M, MDBT50Q-U1M
Product Name : Bluetooth Low Energy & IEEE 802.15.4 Combo Module
Brand Name : Raytac
Applicant : Raytac Corporation
Address of Applicant : 5F, No.3, Jiankang Rd., Zhonghe Dist., New Taipei City, 235, Taiwan
Test Report Number : MH/2018/60113
Date of Issue : Jul. 26, 2018
Applicable Standards : EN 301 489 –1 v2.0 : 2017-03 (Draft)
EN 301 489 –17 v3.2.0 : 2017-03 (Draft)
EN 55032 : 2015+AC:2016-07
EN 61000-4-2 : 2009, EN 61000-4-3 : 2006+A1:2008+A2:2010

Conclusion

The apparatus meets the requirements of the above standards and hence compliance the essential requirements under article 3.1b of the RED (2014/53/EU) Directive.

*This verification is only valid for the equipment and configuration described, and in conjunction with the test report as detailed above.



Authorized Signatory:

Bill Cheng

SGS TAIWAN LTD.
Bill Cheng
Technical Section Manager

9.6. IC Certificate (Canada)

BLE 5.0 and IEEE 802.15.4 approved.

<p>telefication bv The Netherlands Chamber of Commerce 51565536 www.telefication.com</p>			
<p>TECHNICAL ACCEPTANCE CERTIFICATE</p>		<p>CERTIFICAT D'ACCEPTABILITÉ TECHNIQUE</p>	
CERTIFICATION No. No. DE CERTIFICATION	8017A-MDBT50Q		
TELEFICATION No. No. DE TELEFICATION	182170262/AA/00		
TEST SITE No. No. DE LABORATOIRE	4620A-5		
ISSUED TO DÉLIVRÉ A	Raytac Corporation		
TYPE OF EQUIPMENT GENRE DE MATÉRIEL	Bluetooth device Spread Spectrum/Digital Device (2400-2483.5 MHz)		
TRADE NAME AND MODEL MARQUE ET MODELE	Raytac / MDBT50Q Raytac / MDBT50Q-1M Raytac / MDBT50Q-P1M		
CERTIFIED TO CERTIFIÉ SELON LE	SPECIFICATION CAHIER DES CHARGES	RSS-102 RSS-247	ISSUE EDITION 5 2
<p>Certification of equipment means only that the equipment has met the requirements of the above-noted specification. Licence applications, where applicable to use certified equipment, are acted on accordingly by the ISSED issuing office and will depend on the existing radio environment, service and location of operation. This certificate is issued on condition that the holder complies and will continue to comply with the requirements and procedures issued by ISSED. The equipment for which this certificate is issued shall not be manufactured, imported, distributed, leased, offered for sale or sold unless the equipment complies with the applicable technical specifications and procedures issued by ISSED.</p>		<p>La certification du matériel signifie seulement que le matériel a satisfait aux exigences de la norme indiquée ci-dessus. Les demandes de licences nécessaires pour l'utilisation du matériel certifié sont traitées en conséquence par le bureau de délivrance d'ISSE et dépendent des conditions radio ambiantes, du service et de l'emplacement d'exploitation. Le présent certificat est délivré à la condition que le titulaire satisfasse et continue de satisfaire aux exigences et aux procédures d'ISSE. Le matériel à l'égard duquel le présent certificat est délivré ne doit pas être fabriqué, importé, distribué, loué, mis en vente ou vendu à moins d'être conforme aux procédures et aux spécifications techniques applicables publiées par ISSE.</p>	
<p>ISSUED BY TELEFICATION BV (NL0001), RECOGNIZED CERTIFICATION BODY BY INNOVATION, SCIENCE AND ECONOMIC DEVELOPMENT CANADA DÉLIVRÉ PAR TELEFICATION BV (NL0001), ORGANISME DE CERTIFICATION RECONNU PAR INNOVATION, SCIENCES ET DÉVELOPPEMENT ÉCONOMIQUE CANADA</p>			
<p><i>I hereby attest that the subject equipment was tested and found in compliance with the above-noted specification. J'atteste, par la présente, que le matériel a fait l'objet d'essai et a été jugé conforme à la spécification ci-dessus</i></p>			
DATE 30 Jul 2018 BY	Ramy Nabod Product Assessor		
This certificate has one annex.			

9.7. SRRC Certificate (China)

BLE 5.0 and IEEE 802.15.4 approved.



9.8. KC Certificate (South Korea)

BLE 5.0 and IEEE 802.15.4 approved.



2CC6-E6D4-B6AA-9E64

방송통신기자재등의 적합인증서 <i>Certificate of Broadcasting and Communication Equipments</i>	
상호 또는 성명 <i>Trade Name or Applicant</i>	Raytac Corporation
기자재명칭(명칭) <i>Equipment Name</i>	특정소출력 무선기기(무선데이터통신시스템용 무선기기)
기본모델명 <i>Basic Model Number</i>	MDBT50Q-U
파생모델명 <i>Series Model Number</i>	MDBT50Q, MDBT50Q-P
인증번호 <i>Certification No.</i>	R-C-ryt-MDBT50Q
제조사/제조국가 <i>Manufacturer/ Country of Origin</i>	Raytac Corporation / 대한
인증연월일 <i>Date of Certification</i>	2018-08-17
기타 <i>Others</i>	
<p>위 기자재는 「전파법」 제58조의2 제2항에 따라 인증되었음을 증명합니다. It is verified that foregoing equipment has been certificated under the Clause 2, Article 58-2 of Radio Waves Act.</p> <p style="text-align: right;">2018년(Year) 08월(Month) 17일(Day)</p> <p style="text-align: center;">국립전파연구원장 </p> <p style="text-align: center;"><i>Director General of National Radio Research Agency</i></p> <p style="text-align: center; font-size: small;">※ 인증 받은 방송통신기자재는 반드시 "적합성평가표시" 를 부착하여 유통하여야 합니다. 위반시 과태료 처분 및 인증이 취소될 수 있습니다.</p>	

9.9. WPC (ETA) Certificate (India)

BLE 5.0 and IEEE 802.15.4 approved.

MDBT50Q

 Government of India Ministry of Communications & IT Department of Telecommunications, Wireless Planning and Coordination Wing RLO SR, IMS CAMPUS, PERUNGUDI, CHENNAI - 600 096		
FileNo. J-22022/01/2017-RLO(SR) 6476	Date 22-10-2018	
ETA Certificate No: ETA - 1323/2017-RLO(SR) On-Line ID 2018118031		
Equipment Type Approval is hereby granted for under mentioned equipment for operation with following parameters/conditions:		
I. Details of Applicant and parameters of Equipment:		
1. Name and address of the Applicant	Atoll Solutions Private Limited #229, 2nd Floor, 2A Main, 5th Cross New Thippasandra, Bangalore-560075	
2. Equipment	Bluetooth Low Energy & IEEE 802.15.4 Combo Module	
3. Model No.	MDBT50Q-1M	
4. Manufactured by	Raytac Corporation 5F No.3 Jiankang Rd. Zhonghe Dist., New Taipei City, 235, Taiwan.	
5. Frequency Range (MHz)	2402 - 2480 MHz	
6. Max. Output Power	8.19 dBm	
7. Modulation	O-QPSK, GFSK.	
8. Remarks	This ETA is for RF Module available in the above equipment operating in above frequency band. This is not Import license, separate import license is required for Import.	

MDBT50Q-P



Government of India

Ministry of Communications & IT

Department of Telecommunications, Wireless Planning and Coordination Wing
RLO SR, IMS CAMPUS, PERUNGUDI, CHENNAI - 600 096



FileNo. J-22022/01/2017-RLO(SR)/6478

Date 22-10-2018

ETA Certificate No: ETA - 1325/2017-RLO(SR) On-Line ID 2018118033

Equipment Type Approval is hereby granted for under mentioned equipment for operation with following parameters/conditions:

I. Details of Applicant and parameters of Equipment:

1. Name and address of the Applicant	Atoll Solutions Private Limited #229, 2nd Floor, 2A Main, 5th Cross New Thippasandra, Bangalore-560075
2. Equipment	Bluetooth Low Energy & IEEE 802.15.4 Combo Module
3. Model No.	MDBT50Q-P1M
4. Manufactured by	Raytac Corporation 5F No.3 Jiankang Rd. Zhonghe Dist., New Taipei City, 235, Taiwan.
5. Frequency Range (MHz)	2402 - 2480 MHz
6. Max. Output Power	8.19 dBm
7. Modulation	O-QPSK, GFSK.
8. Remarks	This ETA is for RF Module available in the above equipment operating in above frequency band. This is not Import license, separate import license is required for Import.

9.10. RoHS & REACH Report

Please visit "[Support](#)" page of our website to download.

10. Notes and Cautions

Module is not designed to last for a lifetime. Like general products, it is expected to be worn out after continuous usage through the years. To assure that product will perform better and last longer, please make sure you:

- Follow the guidelines of this document while designing circuit/end-product. Any discrepancy of core Bluetooth technology and technical specification of IC should refer to definition of Bluetooth Organization and Nordic Semiconductor as final reference.
- Do not supply voltage that is not within range of specification.
- Eliminate static electricity at any cost when working with the module as it may cause damage. It is highly recommended adding anti-ESD components to circuit design to prevent damage from real-life ESD events. Anti-ESD methods can be also applied in mechanical design.
- Do not expose modules under direct sunlight for long duration. Modules should be kept away from humid and salty air conditions, and any corrosive gasses or substances. Store it within -40°C to $+125^{\circ}\text{C}$ before and after installation.
- Avoid any physical shock, intense stress to the module or its surface.
- Do not wash the module. No-Clean Paste is used in production. Washing it will oxidize the metal shield and have chemistry reaction with No-Clean Paste. Functions of the module are not guaranteed if it has been washed.

The module is not suitable for life support device or system and not allowed to be used in destructive device or systems in any direct or indirect ways. The customer agrees to indemnify Raytac for any losses when applying modules in applications such as the ones described above.

11. Basic Facts for nRF52 Chip

Below is the comparison chart between nRF52840, nRF52832 and nRF52810. Any discrepancy shall refer to Nordic's technical document as final reference.

Nordic Solution

	nRF52840	nRF52832	nRF52810	nRF52811
RAYTAC Model No.	MDBT50Q-1M MDBT50Q-P1M MDBT50Q-U1M	MDBT42Q-512KV2 MDBT42Q-P512KV2 MDBT42 series MDBT42V series	MDBT42Q-192K MDBT42Q-P192K	MDBT42Q-192KL MDBT42Q-P192KL
Bluetooth 5 Long Range (125kbps)	V			V
Bluetooth 5 High Speed	V	V	V	V
Bluetooth 5 Ad. Extention (x8)	V	V	V	V
Flash (kBytes)	1024	512	192	192
RAM (kBytes)	256	64	24	24
ANT Plus	V	V	V	V
IEEE 802.15.4	V			V
ARM® TrustZone® Cryptocell	V			
USB	V			
QSPI	V			
NFC	V	V		
I2S	V	V		
SPI, TWI, UART, PWM	V	V	V	V
PDM	V	V	V	V
ADC, Comparators	V	V	V	V
Supply Range (V)	1.7 to 5.5	1.7 to 3.6	1.7 to 3.6	1.7 to 3.6

12. Useful Links

- **Nordic Infocenter:** <https://infocenter.nordicsemi.com/index.jsp>
All the necessary technical files and software development kits of Nordic's chip are on this website.
- **Nordic DevZone:** <https://devzone.nordicsemi.com/questions/>
A highly recommended website for firmware developer. Interact, discuss and consult with other fellow developers and Nordic's employees to get answers to your questions. The site also includes tutorials in detail to help you get started.
- **Official Page of nRF52840 :** <https://www.nordicsemi.com/eng/Products/nRF52840>
A brief introduction to nRF52840 and download links for Nordic's developing software and SoftDevices.

Full List of Raytac's BLE Modules



MDBT40 & MDBT40-P Series

Series	Nordic Solution	Raytac No.	IC Version	Antenna	RAM	Flash Memory
MDBT40	nRF51822	MDBT40-256V3	3	Chip Antenna	16 kb	256 K
		MDBT40-256RV3			32 kb	256 K
MDBT40-P	nRF51822	MDBT40-P256V3	3	PCB Antenna	16 kb	256 K
		MDBT40-P256RV3			32 kb	256 K
MDBT40 - ANT	nRF51422	MDBT40-ANT-256V3	3	Chip Antenna	16 kb	256 K
		MDBT40-ANT-256RV3			32 kb	
MDBT40 - ANT-P	nRF51422	MDBT40-ANT-P256V3	3	PCB Antenna	16 kb	256 K
		MDBT40-ANT-P256RV3			32 kb	
MDBT40 Nano	nRF51822	MDBT40-n256V3	3	N/A	16 kb	256 K
MDBT40 - ANT-Nano	nRF51422	MDBT40-ANT-n256V3	3	N/A	16 kb	256 K

MDBT42Q Series (QFN Package IC)

Series	Nordic Solution	Raytac No.	IC Version	Antenna	RAM	Flash Memory
MDBT42Q	nRF52832	MDBT42Q-512KV2	2	Chip Antenna	64 kb	512 K
	nRF52810	MDBT42Q-192K	1		24 kb	192 K
	nRF52811	MDBT42Q-192KL	1			

MDBT42Q-P	nRF52832	MDBT42Q-P512KV2	2	PCB Antenna	64 kb	512 K
	nRF52810	MDBT42Q-P192K	1		24 kb	192 K
	nRF52811	MDBT42Q-P192KL	1			

MDBT42Q-U	nRF52832	MDBT42Q-U512KV2	2	u.FL Connector	64 kb	512 K
-----------	----------	-----------------	---	----------------	-------	-------

MDBT42 Series (WLCSP Package IC)

Series	Nordic Solution	Raytac No.	IC Version	Antenna	RAM	Flash Memory
MDBT42	nRF52832	MDBT42-512KV2	2	Chip Antenna	64 kb	512 K
MDBT42-P		MDBT42-P512KV2		PCB Antenna		

Series	Nordic Solution	Raytac No.	IC Version	Antenna	RAM	Flash Memory
MDBT42V	nRF52832	MDBT42V-512KV2	2	Chip Antenna	64 kb	512 K
MDBT42V-P		MDBT42V-P512KV2		PCB Antenna		

MDBT50Q Series (aQFN Package IC)

Series	Nordic Solution	Raytac No.	IC Version	Antenna	RAM	Flash Memory
MDBT50Q	nRF52840	MDBT50Q-1MV2	2	Chip Antenna	256 kb	1MB
MDBT50Q-P		MDBT50Q-P1MV2		PCB Antenna		
MDBT50Q-U		MDBT50Q-U1MV2		u.FL Connector		

Dongle	nRF52840	MDBT50Q-RX	1, 2	PCB Antenna	256 kb	1MB
--------	----------	------------	------	-------------	--------	-----

Release Note

- 2017/10/30 Pre-release
- 2018/01/19 Model no. officially changed to MDBT50Q-1M & MDBT50Q-P1M.
- 2018/04/10 Version A (1st release)
- 2018/06/12 Version B
 - (1) Added Chapter 4: Shipment Packaging Info and Chapter 7: Antenna.
- 2018/09/14 Version C
 - (1) Added link of design guide in Chapter 2
 - (2) Updated photo of module in Chapter 4 and added marking and tray info.
 - (3) Updated schematic in Chapter 8 for easier understanding.
 - (4) Updated Declaration ID & regional certification info in Chapter 9.
 - (5) Added “No-Wash” warning in Chapter 10.
- 2018/11/01 Version D
 - (1) Updated drawing in Chapter 2 for a better understanding of PCB measurement.
 - (2) Updated Chapter 4 with new label info.
 - (3) Added WPC (ETA) certificates in Chapter 9: Certification.
- 2019/05/03 Version E
 - (1) Updated model no. to MDBT50Q-1MV2 & MDBT50Q-P1MV2 because of revision 2 SoC.
 - (2) Updated Chapter 4: Shipment Packaging Info with new module photo, model no. and added tape & reel info.
 - (3) Updated Chapter 5: Specification corresponding to Nordic’s new nRF52840 Product Specification V1.1.
 - (4) Added nRF52811 in Chapter 11: Basic Facts for nRF52 Chips and Full List of Raytac’s BLE Modules.