



SXT510VF

ULTRA LOW VF SCHOTTKY BARRIER RECTIFIER

Voltage

100 V

Current

5 A

SMAF

Unit : inch(mm)

Features

- Ideal for automated placement
- Ultra low forward voltage drop, low power loss
- High efficiency operation
- Low thermal resistance
- Ultra thin profile package for space constrained utilization
- Easy pick and place package suitable for automated handling
- Lead free in compliance with EU RoHS 2011/65/EU directive
- Green molding compound as per IEC61249 Std. . (Halogen Free)

Mechanical Data

- Case: SMAF Molded Plastic
- Terminals: Solder plated, solderable per MIL-STD-750, Method 2026
- Polarity: Color band denotes cathode end
- Standard packaging: 12mm tape (EIA-481)
- Weight: 0.0011 ounces, 0.0328 grams
- Marking: Part number

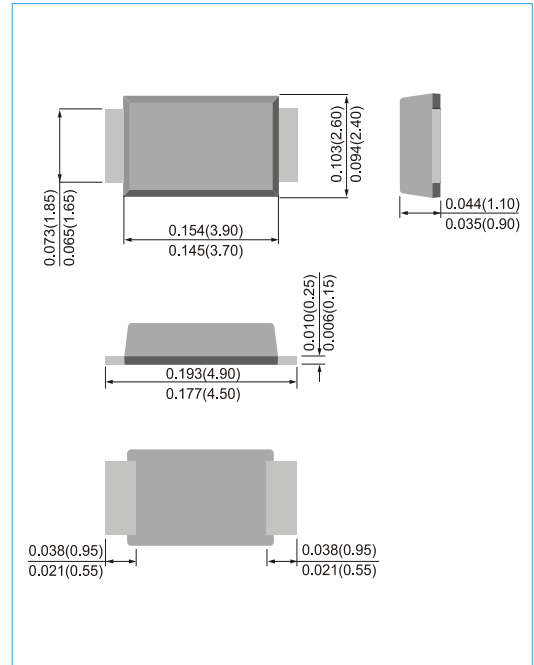
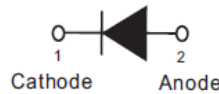

Maximum Ratings And Electrical Characteristics ($T_A=25^{\circ}\text{C}$ unless otherwise noted)

PARAMETER	SYMBOL	LIMIT	UNIT
Maximum repetitive peak reverse voltage	V_{RRM}	100	V
Maximum rms voltage	V_{RMS}	70	V
Maximum dc blocking voltage	V_R	100	V
Maximum average forward rectified current	$I_{F(AV)}$	5	A
Peak forward surge current : 8.3ms single half sine-wave superimposed on rated load	I_{FSM}	80	A
Typical thermal resistance	(Note 1) $R_{\theta JA}$	150	$^{\circ}\text{C/W}$
	(Note 2) $R_{\theta JC}$	25	
Operating junction temperature range	T_J	-55 to +150	$^{\circ}\text{C}$
Storage temperature range	T_{STG}	-55 to +150	$^{\circ}\text{C}$

Note : 1. Mounted on a FR4 PCB, single-sided copper, mini pad.
2. Mounted on 10cm*10cm*0.5mm copper pad area.



SXT510VF

Electrical Characteristics ($T_A=25^{\circ}\text{C}$ unless otherwise noted)

PARAMETER	SYMBOL	TEST CONDITION		MIN.	TYP.	MAX.	UNITS
Breakdown voltage	V_{BR}	$I_R=0.5\text{mA}$	$T_J=25^{\circ}\text{C}$	100	-	-	V
Instantaneous forward voltage	V_F	$I_F=1\text{A}$	$T_J=25^{\circ}\text{C}$	-	0.45	-	V
		$I_F=2\text{A}$		-	0.53	-	
		$I_F=5\text{A}$		-	-	0.71	
		$I_F=1\text{A}$	$T_J=125^{\circ}\text{C}$	-	0.36	-	V
		$I_F=2\text{A}$		-	0.48	-	
		$I_F=5\text{A}$		-	0.62	-	
Reverse current	I_R	$V_R=80\text{V}$	$T_J=25^{\circ}\text{C}$	-	2	-	μA
		$V_R=100\text{V}$	$T_J=25^{\circ}\text{C}$	-	-	20	μA
			$T_J=125^{\circ}\text{C}$	-	3	-	mA



SXT510VF

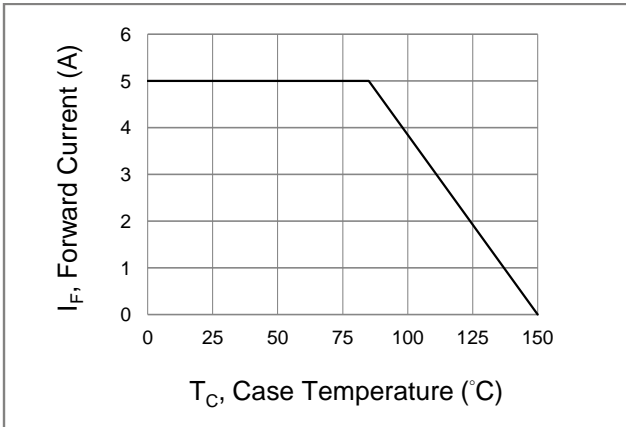

Fig.1 Forward Current Derating Curve

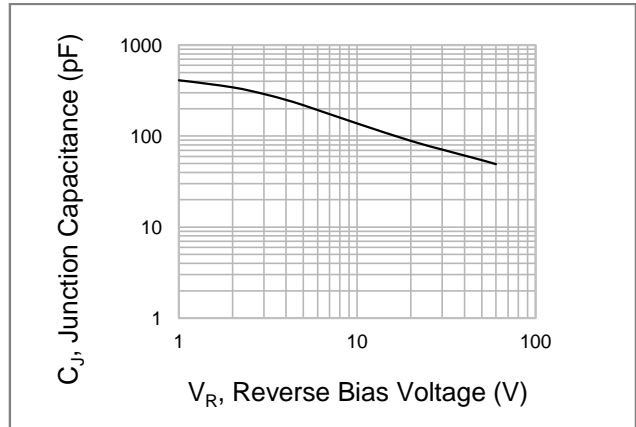

Fig.2 Typical Junction Capacitance

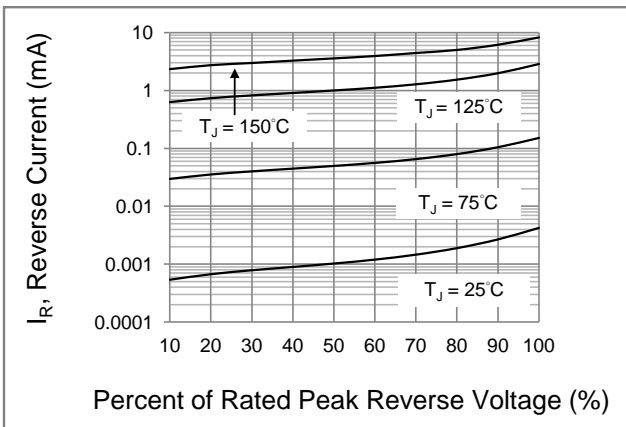

Fig.3 Typical Reverse Characteristics

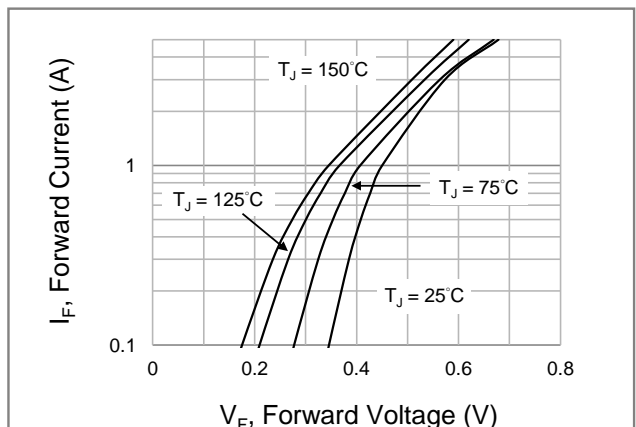

Fig.4 Typical Forward Characteristics

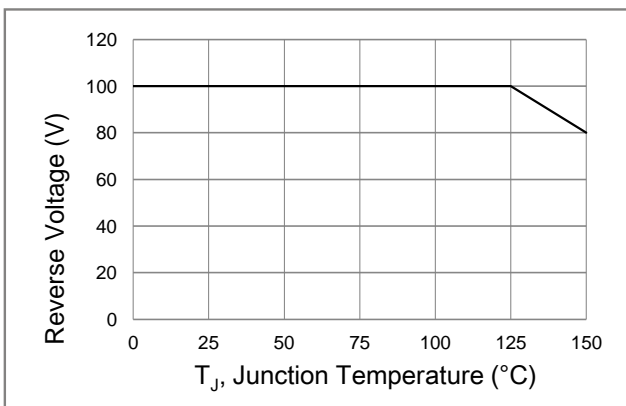
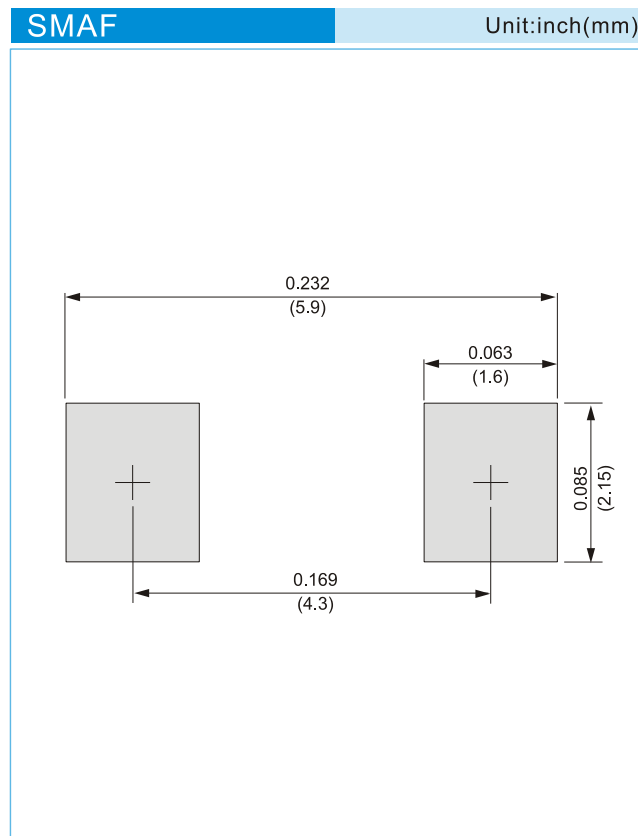

Fig.5 Operating Temperature Derating Curve



SXT510VF

MOUNTING PAD LAYOUT



ORDER INFORMATION

- Packing information
T/R – 10K per 13" plastic Reel
T/R – 3K per 7" plastic Reel



SXT510VF

Part No_packing code_Version

SXT510VF_R2_00001

For example :

RB500V-40_R2_00001

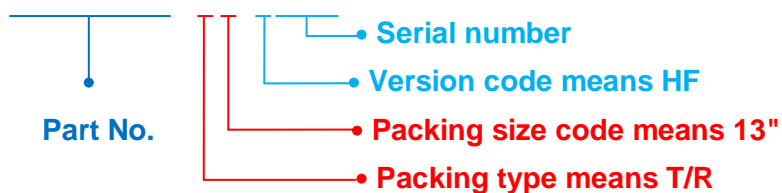

Packing Code XX				Version Code XXXXX		
Packing type	1 st Code	Packing size code	2 nd Code	HF or RoHS	1 st Code	2 nd ~5 th Code
Tape and Ammunition Box (T/B)	A	N/A	0	HF	0	serial number
Tape and Reel (T/R)	R	7"	1	RoHS	1	serial number
Bulk Packing (B/P)	B	13"	2			
Tube Packing (T/P)	T	26mm	X			
Tape and Reel (Right Oriented) (TRR)	S	52mm	Y			
Tape and Reel (Left Oriented) (TRL)	L	PANASERT T/B CATHODE UP (PBCU)	U			
FORMING	F	PANASERT T/B CATHODE DOWN (PBCD)	D			



SXT510VF

Disclaimer

- Reproducing and modifying information of the document is prohibited without permission from Panjit International Inc..
- Panjit International Inc. reserves the rights to make changes of the content herein the document anytime without notification. Please refer to our website for the latest document.
- Panjit International Inc. disclaims any and all liability arising out of the application or use of any product including damages incidentally and consequentially occurred.
- Panjit International Inc. does not assume any and all implied warranties, including warranties of fitness for particular purpose, non-infringement and merchantability.
- Applications shown on the herein document are examples of standard use and operation. Customers are responsible in comprehending the suitable use in particular applications. Panjit International Inc. makes no representation or warranty that such applications will be suitable for the specified use without further testing or modification.
- The products shown herein are not designed and authorized for equipments requiring high level of reliability or relating to human life and for any applications concerning life-saving or life-sustaining, such as medical instruments, transportation equipment, aerospace machinery et cetera. Customers using or selling these products for use in such applications do so at their own risk and agree to fully indemnify Panjit International Inc. for any damages resulting from such improper use or sale.
- Since Panjit uses lot number as the tracking base, please provide the lot number for tracking when complaining.