



# SBT40100VCT

## ULTRA LOW VF SCHOTTKY RECTIFIER

**VOLTAGE** 100 Volt **CURRENT** 40 Ampere

### FEATURES

- Ultra Low forward voltage drop, low power loss
- High efficiency operation
- Lead free in compliance with EU RoHS 2011/65/EU directive
- Green molding compound as per IEC61249 Std. . (Halogen Free)

### MECHANICAL DATA

- Case : TO-220AB, Plastic
- Terminals : Solderable per MIL-STD-750, Method 2026
- Weight: 0.067 ounces, 1.89 grams

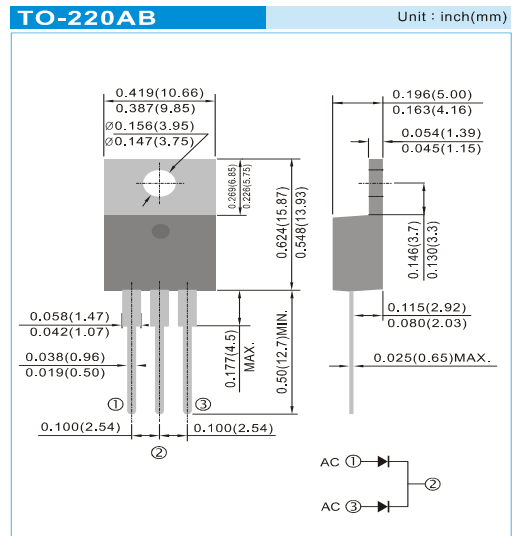

### MAXIMUM RATINGS( $T_A=25^{\circ}\text{C}$ unless otherwise noted)

| PARAMETER   | SYMBOL          | VALUE        | UNIT                        |
|---|-----------------|--------------|-----------------------------|
| Maximum repetitive peak reverse voltage   | $V_{RRM}$       | 100          | V                           |
| Maximum rms voltage   | $V_{RMS}$       | 70           | V                           |
| Maximum dc blocking voltage   | $V_R$           | 100          | V                           |
| Maximum average forward rectified current   | $I_{F(AV)}$     | 40<br>20     | A                           |
| Peak forward surge current : 8.3ms single half sine-wave superimposed on rated load | $I_{FSM}$       | 250          | A                           |
| Typical thermal resistance  | $R_{\theta JC}$ | 2            | $^{\circ}\text{C}/\text{W}$ |
| Operating junction temperature range  | $T_J$           | -55 to + 150 | $^{\circ}\text{C}$          |
| Storage temperature range   | $T_{STG}$       | -55 to + 150 | $^{\circ}\text{C}$          |

Note : 1. Mounted on infinite heatsink.

### ELECTRICAL CHARACTERISTICS( $T_A=25^{\circ}\text{C}$ unless otherwise noted)

| PARAMETER                               | SYMBOL   | TEST CONDITIONS                                       | MIN. | TYP. | MAX. | UNIT          |
|---|----------|---|------|------|------|---------------|
| Breakdown voltage per diode             | $V_{BR}$ | $I_R=0.5\text{mA}$                                    | 100  | -    | -    | V             |
| Instantaneous forward voltage per diode | $V_F$    | $I_F=5\text{A}$                                       | -    | 0.48 | -    | V             |
|   |          | $I_F=10\text{A}$                                      | -    | 0.57 | -    | V             |
|   |          | $I_F=20\text{A}$                                      | -    | 0.71 | 0.76 | V             |
|   |          | $I_F=5\text{A}$                                       | -    | 0.41 | -    | V             |
| Reverse current per diode               | $I_R$    | $I_F=10\text{A}$                                      | -    | 0.53 | -    | V             |
|   |          | $I_F=20\text{A}$                                      | -    | 0.68 | -    | V             |
|   |          | $V_R=70\text{V}$                                      | -    | 5    | -    | $\mu\text{A}$ |
|   |          | $V_R=70\text{V}$                                      | -    | 6    | -    | mA            |
| Reverse current per diode               | $I_R$    | $V_R=100\text{V}$                                     | -    | -    | 120  | $\mu\text{A}$ |
|   |          | $T_J=25^{\circ}\text{C}$<br>$T_J=125^{\circ}\text{C}$ | -    | 12   | -    | mA            |



# SBT40100VCT

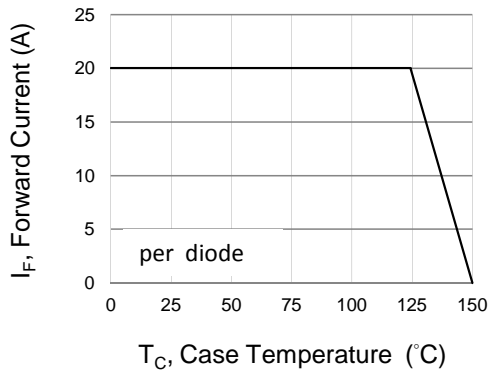

**Fig.1 Forward Current Derating Curve**

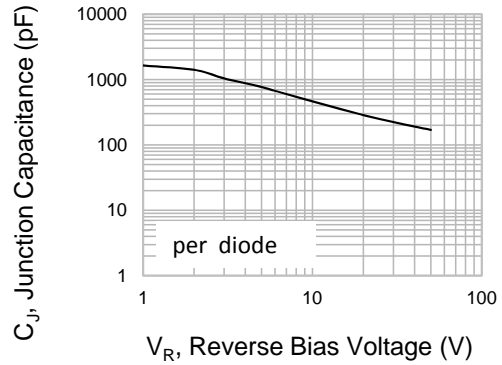

**Fig.2 Typical Junction Capacitance**

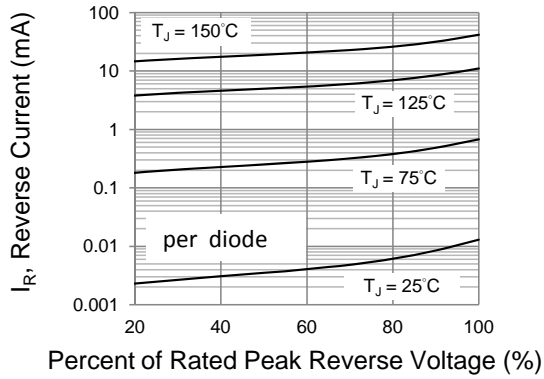

**Fig.3 Typical Reverse Characteristics**

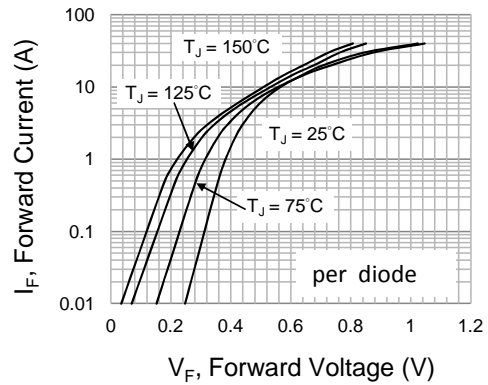

**Fig.4 Typical Forward Characteristics**

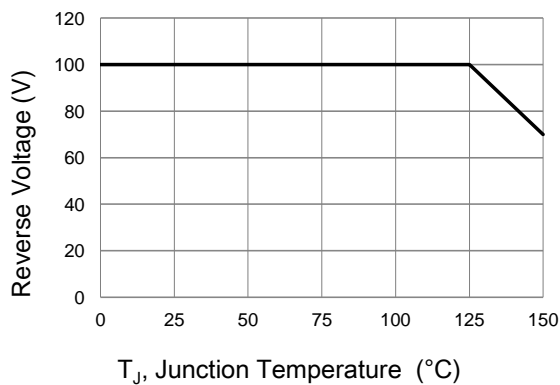

**Fig.5 Operating Temperature Derating Curve**



# SBT40100VCT

Part No\_packing code\_Version

SBT40100VCT\_T0\_00001

For example :

RB500V-40\_R2\_00001

Part No.

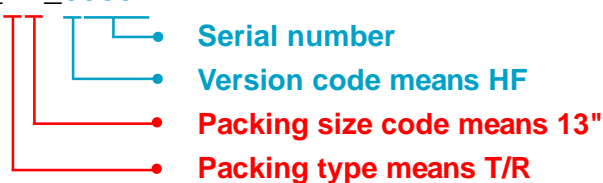

| Packing Code <b>XX</b>               |                      |                                  |                      | Version Code <b>XXXXX</b> |                      |                                       |
|--------------------------------------|----------------------|----------------------------------|----------------------|---------------------------|----------------------|---------------------------------------|
| Packing type                         | 1 <sup>st</sup> Code | Packing size code                | 2 <sup>nd</sup> Code | HF or RoHS                | 1 <sup>st</sup> Code | 2 <sup>nd</sup> ~5 <sup>th</sup> Code |
| Tape and Ammunition Box (T/B)        | A                    | N/A                              | 0                    | HF                        | 0                    | serial number                         |
| Tape and Reel (T/R)                  | R                    | 7"                               | 1                    | RoHS                      | 1                    | serial number                         |
| Bulk Packing (B/P)                   | B                    | 13"                              | 2                    |                           |                      |                                       |
| Tube Packing (T/P)                   | T                    | 26mm                             | X                    |                           |                      |                                       |
| Tape and Reel (Right Oriented) (TRR) | S                    | 52mm                             | Y                    |                           |                      |                                       |
| Tape and Reel (Left Oriented) (TRL)  | L                    | PANASERT T/B CATHODE UP (PBCU)   | U                    |                           |                      |                                       |
| FORMING                              | F                    | PANASERT T/B CATHODE DOWN (PBCD) | D                    |                           |                      |                                       |



## SBT40100VCT

---

### Disclaimer

- Reproducing and modifying information of the document is prohibited without permission from Panjit International Inc..
- Panjit International Inc. reserves the rights to make changes of the content herein the document anytime without notification. Please refer to our website for the latest document.
- Panjit International Inc. disclaims any and all liability arising out of the application or use of any product including damages incidentally and consequentially occurred.
- Panjit International Inc. does not assume any and all implied warranties, including warranties of fitness for particular purpose, non-infringement and merchantability.
- Applications shown on the herein document are examples of standard use and operation. Customers are responsible in comprehending the suitable use in particular applications. Panjit International Inc. makes no representation or warranty that such applications will be suitable for the specified use without further testing or modification.
- The products shown herein are not designed and authorized for equipments requiring high level of reliability or relating to human life and for any applications concerning life-saving or life-sustaining, such as medical instruments, transportation equipment, aerospace machinery et cetera. Customers using or selling these products for use in such applications do so at their own risk and agree to fully indemnify Panjit International Inc. for any damages resulting from such improper use or sale.
- Since Panjit uses lot number as the tracking base, please provide the lot number for tracking when complaining.