

SPECIFICATION

Customer : _____
Model Name: SAT043AT40R04D-FG104076TK
ERP NO. : 1090430031
Spec Vision: V.1
Date: 2019/01/25

- Preliminary Specification
- Final Specification

Approved by	Comment

Prepared by	Reviewed by	Approved by

Contents

1. General Specifications.....	4
2. Pin Assignment.....	5
3. Operation Specifications.....	6
3.1. Absolute Maximum Ratings.....	6
3.1.1. Recommended Operation Range.....	6
3.1.2. Backlight Driving Conditions.....	7
3.2. Power Sequence.....	8
3.2.1. Power On Sequence.....	8
3.2.2. Power Off Sequence.....	9
3.3. Timing Characteristics.....	10
3.3.1. RGB Input Timing Table.....	10
3.3.2. Timing Diagram.....	11
4. Optical Specifications.....	14
5. Reliability Test Items.....	15
6. Mechanical Drawing.....	16

1. General Specifications

NO.	Item	Specification	Remark
1	Panel Size	4.3 inch(Diagonal)	
2	Resolution	480 x 3(RGB) x 272	
3	Driver Method	A-Si TFT active matrix	
4	Active Area	95.04(W) x 53.856(H) mm	
5	Dot Pitch	0.198(W) x 0.198(H) mm	
6	Pixel Arrangement	RGB-stripe	
7	Module Size	103.9(W) x 75.8(H) x5.70(D) mm	
8	Display Mode	Normally White	
9	Display Color	16.7M	
10	Viewing Direction	6 o'clock	
11	Interface	TTL RGB-24Bit parallel interface	
12	Driving IC	ST7282	
13	Weight	TBD	g

2. Pin Assignment

No.	Symbol	Function	Remarks
1	VLED-	Power for LED backlight (Cathode)	
2	VLED+	Power for LED backlight (anode)	
3	GND	Power ground	
4	VDD	Power for digital circuit	
5-12	R0~R7	Red data	
13-20	G0~G7	Green data	
21~28	B0~B7	Blue data	
29	GND	Power ground	
30	PCLK	Pixel clock	
31	DISP	Display On/Off , "Normally DISP=0, Standby mode"	
32	HSYNC	Horizontal Sync input	
33	VSYNC	Vertical Sync input	
34	DE	Data input enable	
35	NC	No connection	
36	GND	Power ground	
37	XR	Right electrode-differential analog	When this pin not used,please leave it open
38	YD	Bottom electrode-differential analog	
39	XL	Left electrode-differential analog	
40	YU	Top electrode-differential analog	

3. Operation Specifications

3.1. Absolute Maximum Ratings

Voltage (AGND=GND=0V, Ta = 25°C)

Parameter	Min.	Max.	Unit
Power Supply Voltage V _{DD}	-0.3	+4.6	V
I/O Supply Voltage V _{DDI}	-0.3	+4.6	V
Charge Pump Supply Voltage P _{VDD}	-0.3	+4.6	V
Storage Temperature	-0.3	+4.6	V
Operating Temperature	-20	70	°C
Storage Temperature	-30	80	°C

Note: The absolute maximum rating values of this product are not allowed to be exceeded at any times. Should a module be used with any of the absolute maximum ratings case ,the module may be permanently destroyed.

3.1.1. Recommended Operation Range

Parameter	Symbol	values			Unit
		Min.	Typ.	Max.	
Digital Supply Voltage	V _{DD}	3.0	3.3	3.6	V
I/O Supply Voltage	V _{DDI}	1.65	-	V _{DD}	V
Charge Pump Supply	P _{VDD}	3.0	3.3	3.6	V
Positive High-Voltage power	V _{GH}	13	15	17.5	V
Negative High-Voltage power	V _{GL}	-11.5	-10	-7	V
Standby Current	I _{sc}	-	-	50	uA
Operation Current	I _{oc}	-	20	-	mA

3.1.2. Backlight Driving Conditions

Parameter	Symbol	Min.	Typ.	Max.	Unit
Supply voltage of white LED backlight	V_L	11.6	13.2	14	V
Current for LED backlight	I_L	30	40	50	mA
Luminance (on the module surface ,CA-210)		160	190	-	cd/m ²
LED life time	-	50000	-	-	Hr

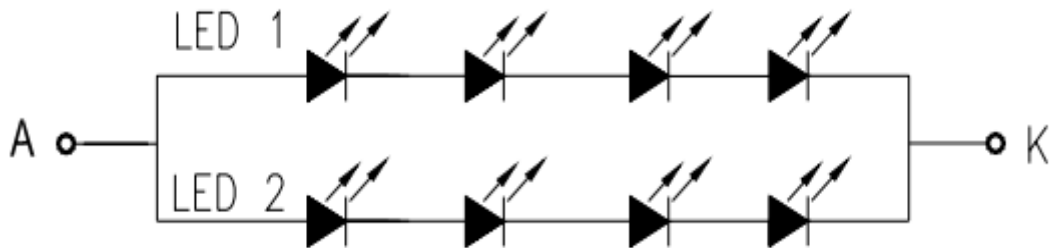

3.2. Power Sequence

3.2.1. Power On Sequence

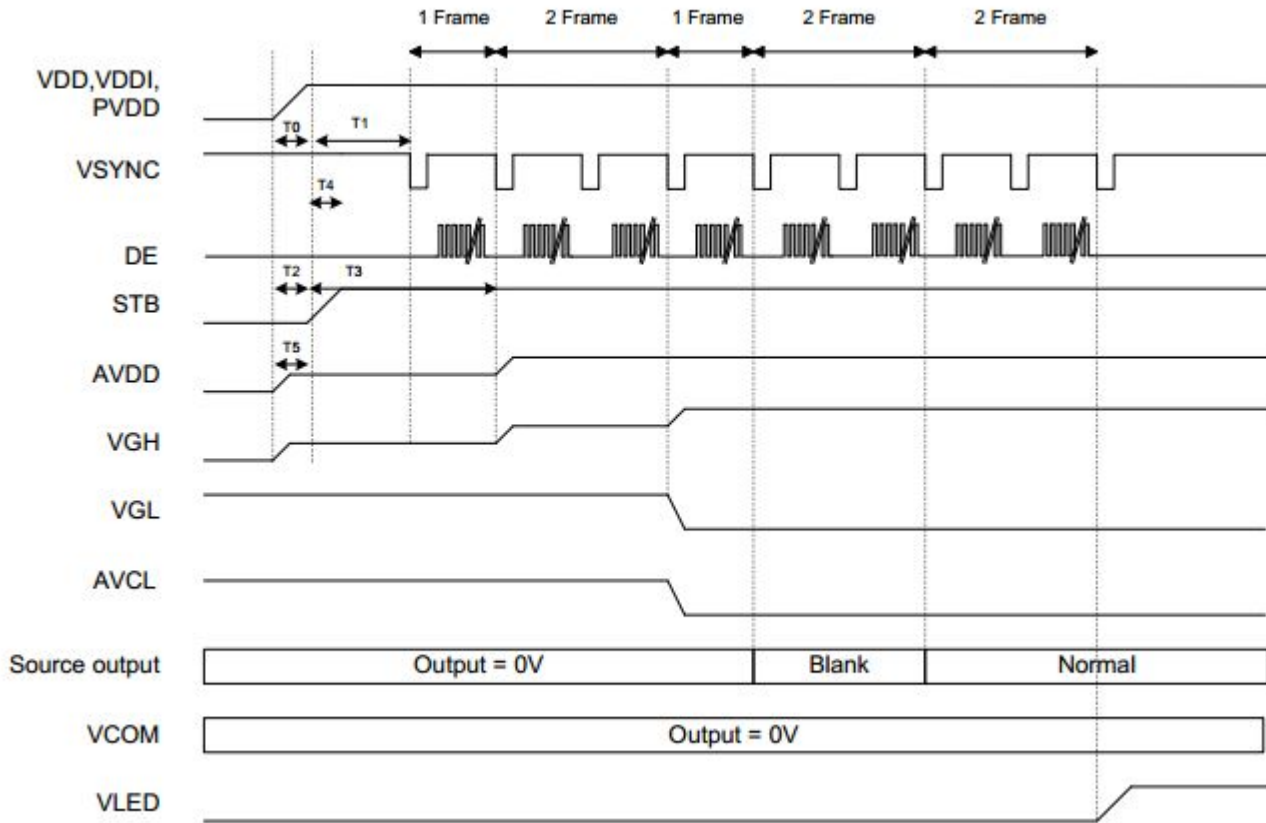

	Description	Min. Time
T0	Determined by the external power	
T1	Time from stable VDD, VDDI, PVDD set-up to the first VSYNC	T1=0
T2	Time from AVDD=0V to AVDD=3.3V	T2=T0
T3	Time from AVDD=3.3V to AVDD=6.0V	T3=T1+ (1*Frame)
T4	Time from stable VDD, VDDI, PVDD set-up to DISP asserted	T4=0
T5	Time from VGH=0V to VGH=3.3V	T5=T0

Note: Recommend the LCM power on rise time T0= 0~ 1ms

3.2.2. Power Off Sequence

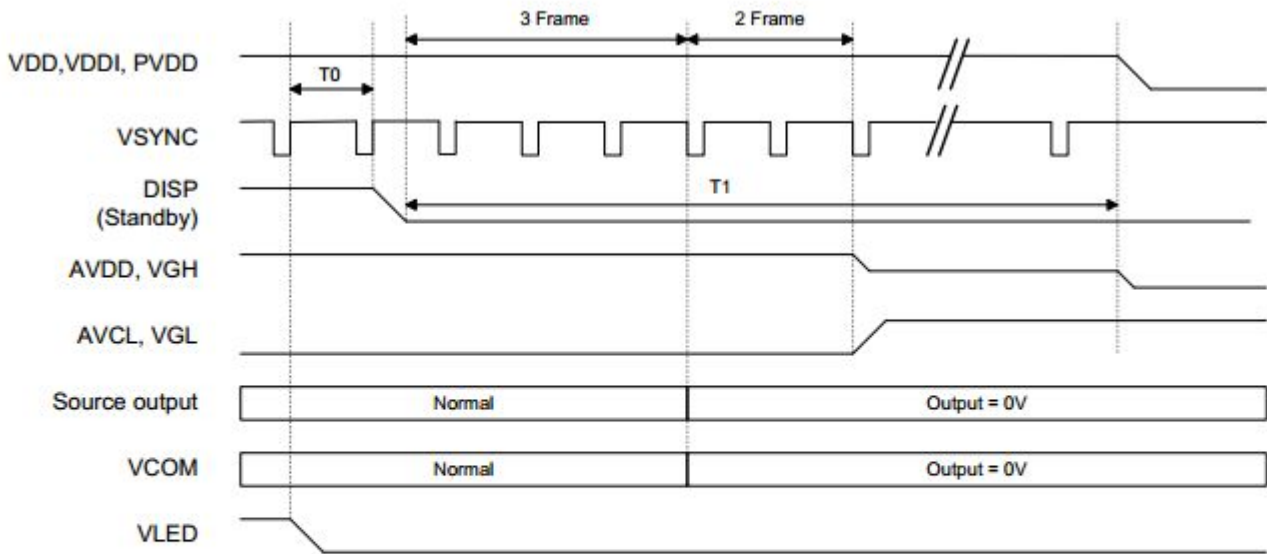

	Description	Min. Time
T0	Time from backlight power off to DISP="L"	1*Frame
T1	Time from DISP="L" to LCM Power off	5*Frame

3.3. Timing Characteristics

3.3.1. RGB Input Timing Table

Parallel 24-bit RGB Timing Table

(PVDD=VDD=VDDI=3.3V,AGND=0V,TA=25 °C)

Item	Symbol	Min.	Typ.	Max.	Unit	Remark	
DCLK Frequency	Fclk	8	9	12	MHz		
DCLK Period	Tclk	83	111	125	ns		
HSYNC	Period Time	Th	485	531	598	DCLK	
	Display Period	Thdisp		480		DCLK	
	Back Porch	Thbp	3	43	43	DCLK	By H_Blanking setting
	Front Porch	Thfp	2	8	75	DCLK	
	Pulse Width	Thw	2	4	75	DCLK	
VSYNC	Period Time	Tv	276	292	321	H	
	Display Period	Tvdisp		272		H	
	Back Porch	Tvbp	2	12	12	H	By V_Blanking setting
	Front Porch	Tvfp	2	8	37	H	
	Pulse Width	Tvw	2	4	37	H	

Note: It is necessary to keep Tvbp =12 and Thbp =43 in sync mode. DE mode is unnecessary to keep it.

Serial 8-bit RGB Timing Table

Item	Symbol	Min.	Typ.	Max.	Unit	Remark	
DCLK Frequency	Fclk	24	27	30	MHz		
DCLK Period	Tclk	33	37	42	ns		
HSYNC	Period Time	Th	1445	1491	1558	DCLK	
	Display Period	Thdisp		1440		DCLK	
	Back Porch	Thbp	3	43	43	DCLK	By H_Blanking setting
	Front Porch	Thfp	2	8	75	DCLK	
	Pulse Width	Thw	2	4	75	DCLK	
VSYNC	Period Time	Tv	276	292		H	
	Display Period	Tvdisp		272		H	
	Back Porch	Tvbp	2	12	12	H	By V_Blanking setting
	Front Porch	Tvfp	2	8	37	H	
	Pulse Width	Tvw	2	4	37	H	

Note: It is necessary to keep Tvbp =12 and Thbp =43 in sync mode. DE mode is unnecessary to keep it.

3.3.2. Timing Diagram

SYNC Mode Timing Diagram

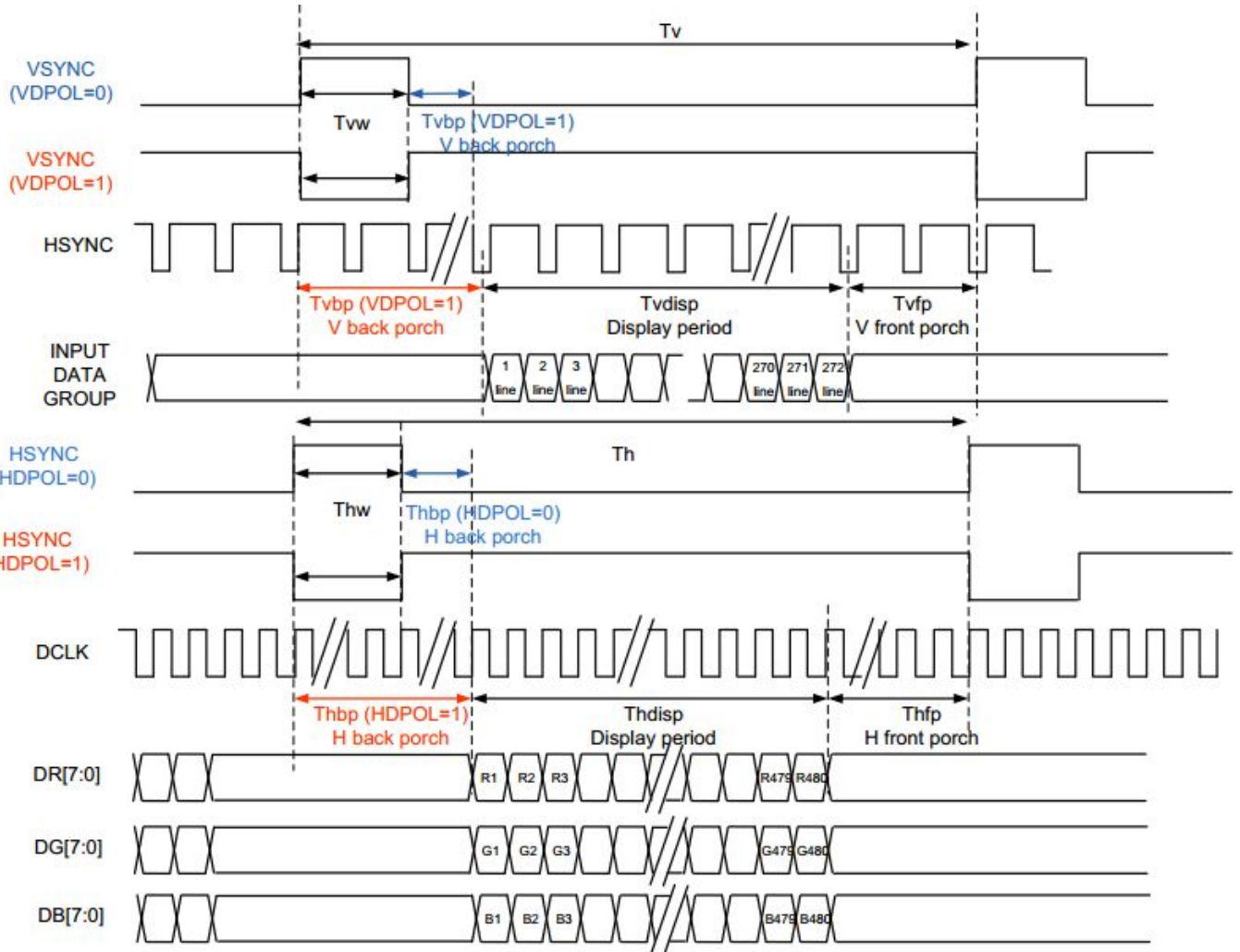

SYNC-DE Mode Timing Diagram

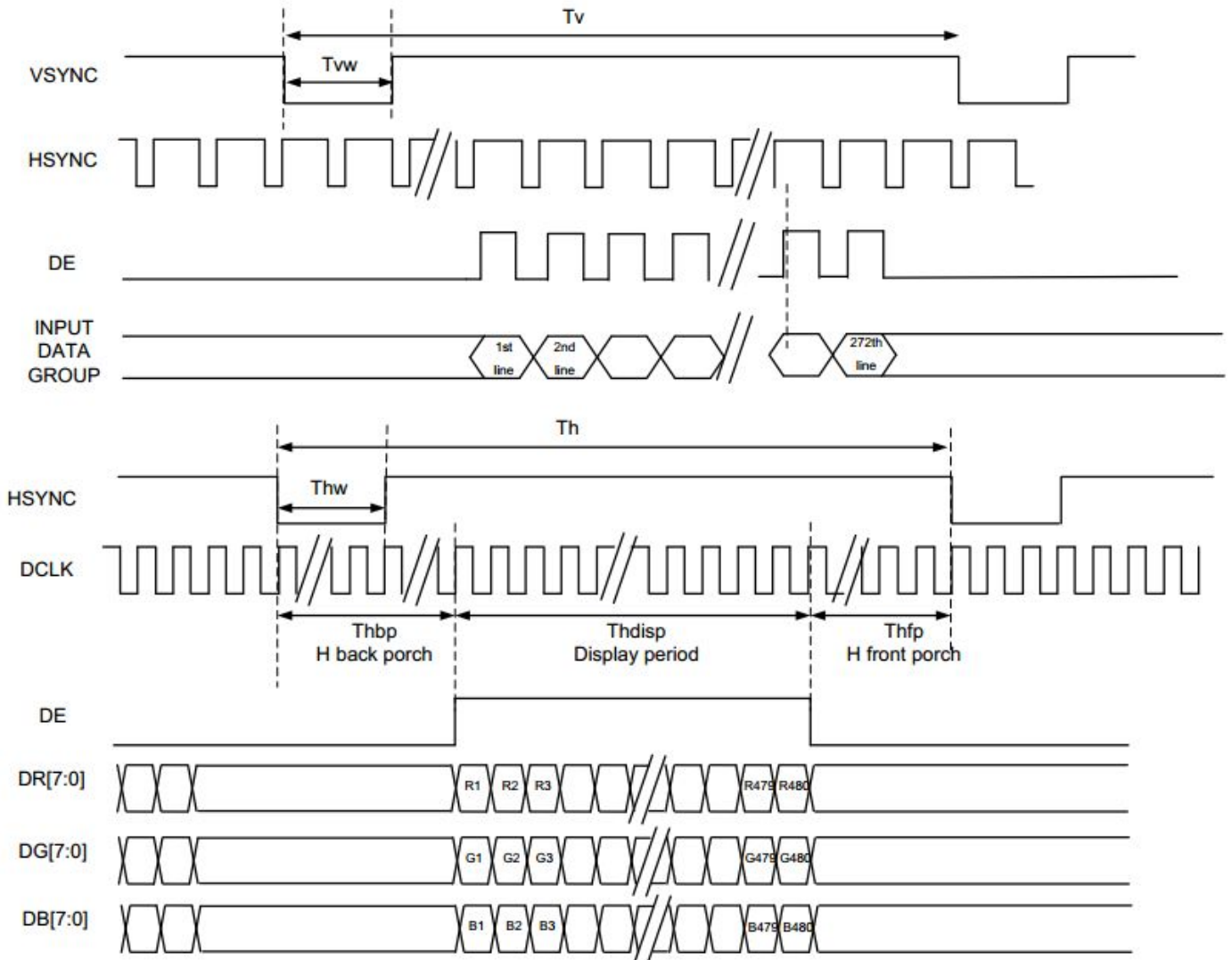

DE Mode Timing Diagram

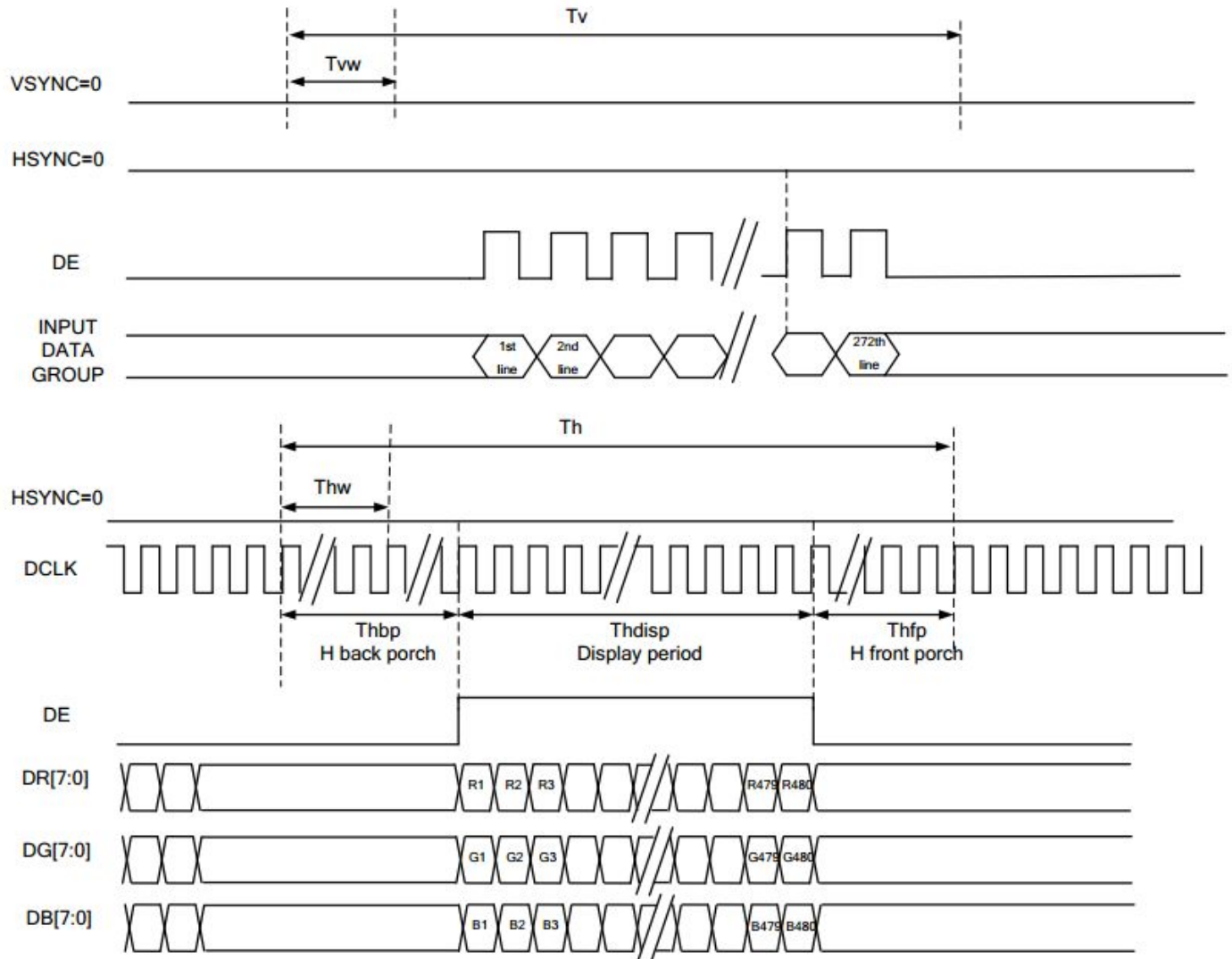

4. Optical Specifications

Item		Symbol	Min.	Typ.	Max.	Unit	Note
Contrast Ratio		CR	300	500	-	-	
Color gamut (NTSC ratio)		-	-	52	-	%	
Response Time		Rising + Falling	-	25	50	ms	
Viewing Angle	Horizontal	θ_{x^+}	50	60	-	degree	
		θ_{x^-}	50	60	-		
	Vertical	θ_{y^+}	30	40	-		
		θ_{y^-}	40	50	-		
Color Filter Chromaticity (CIE1931)	Red	X	-0.02	0.618	+0.02	-	
		Y		0.343			
	Green	X		0.306			
		Y		0.527			
	Blue	X		0.139			
		Y		0.098			
	White	X		0.280			
		Y		0.290			
Luminance (center)		L	160	190	-	cd/m ²	
Luminance Uniformity		ΔL	75	80		%	

Test Condition:

- 1、VDD=3.3V,IL=40mA(Backlight current), the ambient temperature is 25°C.

5. Reliability Test Items

Item	Test Conditions	Remark
High Temperature Storage	Ta=+80℃ 120h	Note1 ,Note4
Low Temperature Storage	Ta=-30℃ 120h	Note1, Note4
High Temperature Operation	Ts=+70℃ 120h	Note2 ,Note4
Low Temperature Operation	Ts=-20℃ 120h	Note4
Operation at High Temperature and Humidity	+60℃ ,90%RH 120h	Note4
Thermal Shock	-20℃/30min~+60℃/30min for a total 100 cycles , Start with cold temperature and end with high temperature	
Package Drop Test	Height 60cm 1corner , 3edges , 6surfaces	
Elector Static Discharge	±2KV,Human Body Mode, 150pF/330Ω	

Note1: Ta is the ambient temperature of samples.

Note2: Ts is the temperature of panel's surfaces.

Note3: In the standard condition, there shall be no practical problem that may affect the display function. After the reliability test, the product only guarantees operation, but doesn't guarantee all of the cosmetic specification.

Note4: before cosmetic and function test, the product must have enough recovery time, at least 2 hours at room temperature.

6. Mechanical Drawing

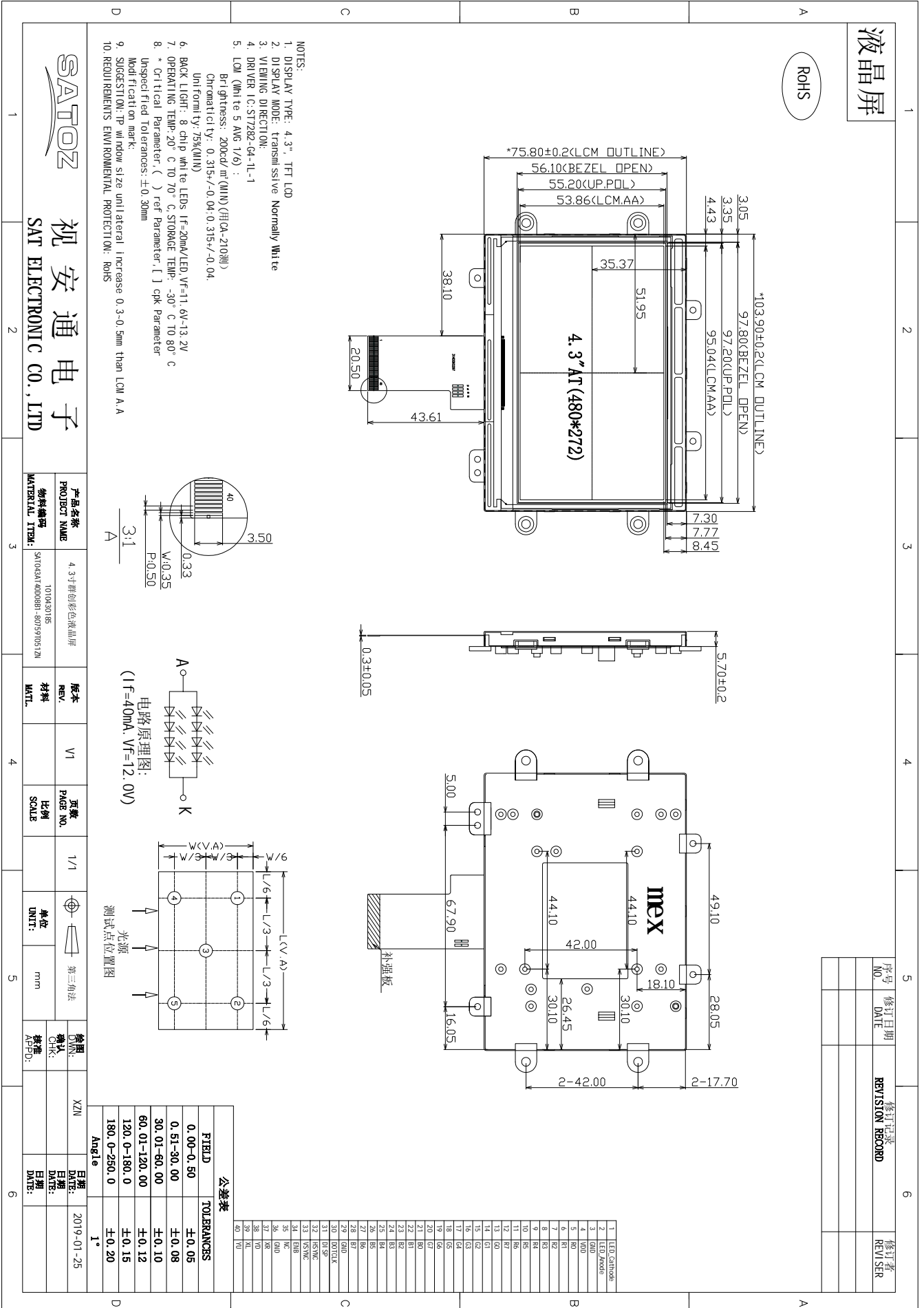

TP

RoHS

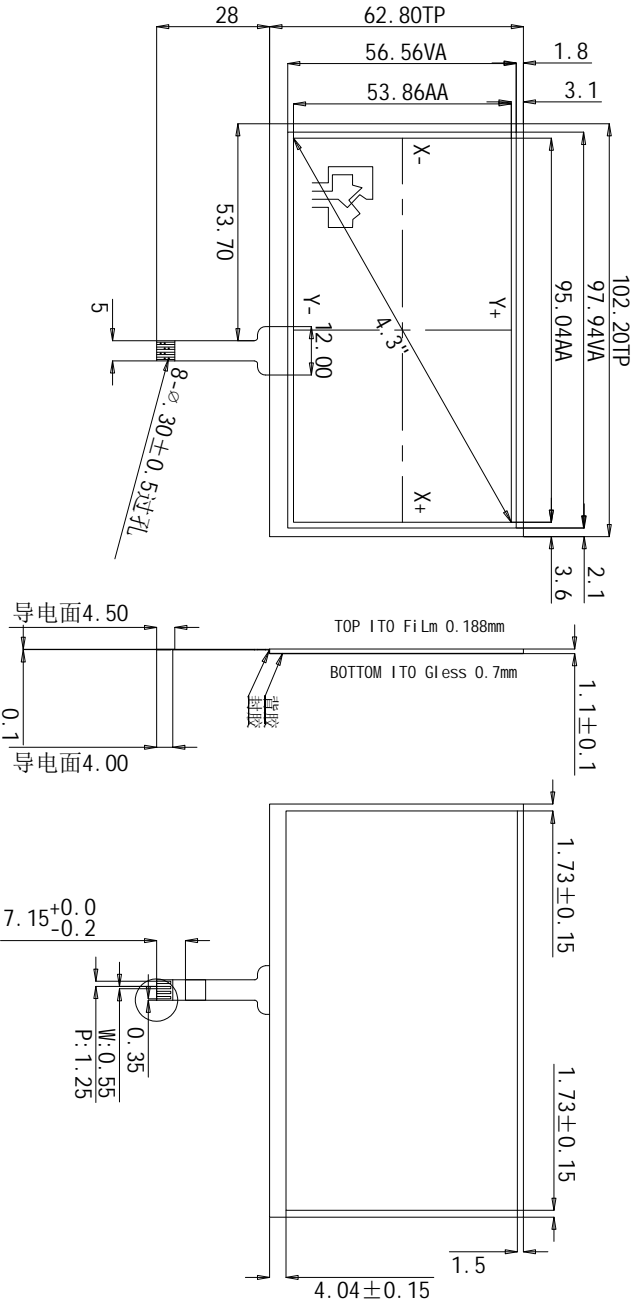

- 1、工作条件 (Operating voltage) : DC5V;
- 2、操作压力 (Operating pressure) : 50-120g;
- 3、线性度 (Linearity) $\leq \pm 1.5\%$;
- 4、绝缘阻抗 (Insulation resistance) $> 20M\Omega$, 25V(DC) ;
- 5、工作环境 (Operating temperature) : $-20^{\circ}C$ $+$ $+70^{\circ}C$;
- 6、储存环境 (Storage temperature) : $-30^{\circ}C$ $+$ $+80^{\circ}C$;
- 7、透光率 (Luminousness) : $> 78\%$;
- 8、结构类型 (Structure types) :
 单层膜 (mono-layer film) / 玻璃型 (glass type) (F/G) ;
 出线方式 (The ways of outgoing lines) : FPC出线 ;
- 9、ITO Film: 雾面防牛刮花 (Matte and scratch-resistant ITO film)。
- 10、使用寿命 (Life time) : 1,000,000次 ;
- 11、响应时间 (Response time) : $< 20ms$;
- 12、未注明公差 (Tolerance) : $\pm 0.5mm$ 。



视安通电子
SAT ELECTRONIC CO., LTD

产品名称 PROJECT NAME	4.3寸电阻膜屏
物料编码 MATERIAL ITEM:	370430001 SAT043R04F02B00-1020A3

版本 REV.	V1
材料 MATEL.	

页数 PAGE NO.	1/1
比例 SCALE	

单位 UNIT:	第三角法
mm	

绘图 DRAW:	XZN
检查 CHK:	
核准 APPD:	

日期 DATE:	2019-01-25
日期 DATE:	
日期 DATE:	

FPC Pin Description:

PIN	OUT
1	X-
2	Y-
3	X+
4	Y+

公差表

FIELD	TOLERANCES
0.00-0.50	± 0.05
0.51-30.00	± 0.08
30.01-60.00	± 0.10
60.01-120.00	± 0.12
120.0-180.0	± 0.15
180.0-250.0	± 0.20

Angle 1°

序号 NO.	修订日期 DATE	修订者 REVISED

修订记录 REVISION RECORD

液晶屏+TP

ROHS

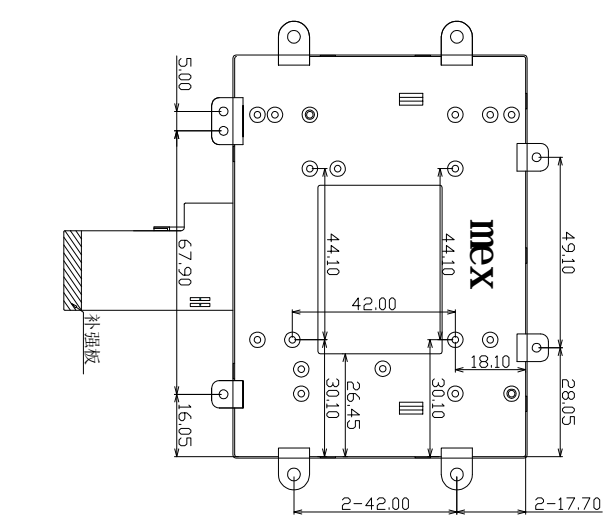
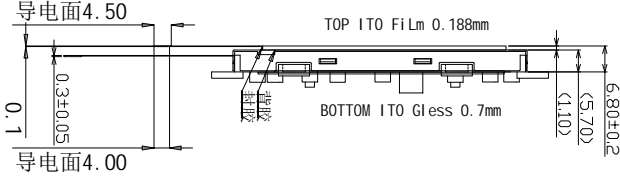
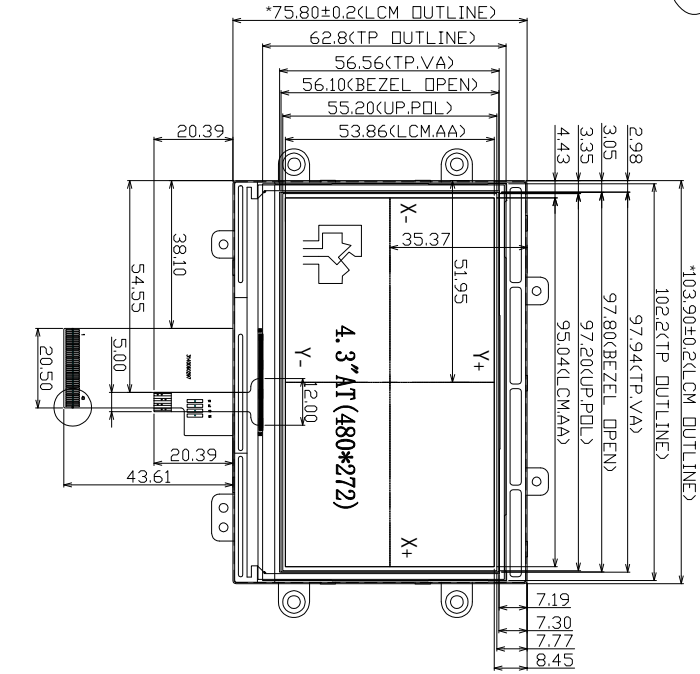

- NOTES:
1. DISPLAY TYPE: 4.3", TFT/resistive touch screen
 2. DISPLAY MODE: Transmissive Normally White
 3. DRIVER IC: ST7282-04-TL-1
 4. TYPICAL LUMINANCE: 160cd/m²(MIN)/ (H/CL-2100cd)
 5. BACK LIGHT: 8 chip white LEDs (F=20mA/LED, VF=1.16V-1.32V)
 6. Structure: F+G
 7. Surface hardness: >3H
 8. Light transmittance: >78%
 9. Operating Environment: -20° C ~ +70° C, Storage Environment: -30° C ~ +80° C
 10. Circuit level: 0.53V 7mA
 11. REQUIREMENTS ENVIRONMENTAL PROTECTION: ROHS

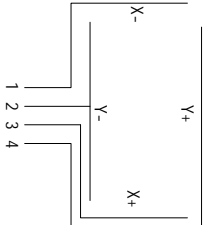
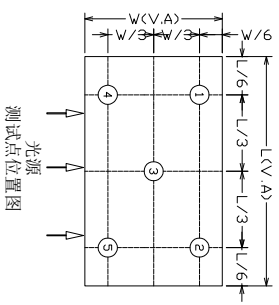
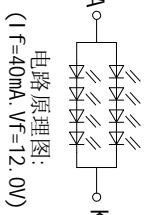
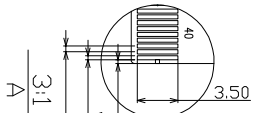

FIELD	TOLERANCES
0.00-0.50	±0.05
0.51-30.00	±0.08
30.01-60.00	±0.10
60.01-120.00	±0.12
120.0-180.0	±0.15
180.0-250.0	±0.20

Pin	Description	Pin	Description
1	LED Cathode	14	G1
2	LED Anode	15	G2
3	GND	16	G3
4	VDD	17	G4
5	R0	18	G5
6	R1	19	G6
7	R2	20	G7
8	R3	21	R0
9	R4	22	R1
10	R5	23	R2
11	R6	24	R3
12	R7	25	R4
13	G0	26	R5
14	G1	27	R6
15	G2	28	R7
16	G3	29	G00
17	G4	30	G000
18	G5	31	HS0
19	G6	32	HS0C
20	G7	33	VS0C
21	R0	34	EM8
22	R1	35	NC
23	R2	36	GND
24	R3	37	K8
25	R4	38	VDD
26	R5	39	VDD
27	R6	40	VDD
28	R7		
29	G00		
30	G000		

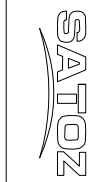

视安通电子
SAT ELECTRONIC CO., LTD

产品名称	4.3寸薄型彩色液晶屏
物料编码	1010430185
MATERIAL ITEM:	SAT03SAT000881-807910512N

版本	REV.	V1
材料	MATL.	
页码	PAGE NO.	1/1
比例	SCALE	
单位	UNIT:	mm
第三角法		

绘图	XZM
审核	
批准	
日期	2019-01-25

日期	2019-01-25
日期	
日期	
日期	

序号	修订日期	修订记录	修订者
NO.	DATE	REVISION RECORD	REVISED