

Features

- Low Distortion Transformer Signal Coupling (0.01% max)
- Complete Ringing Detector Circuit
- Low Power Hook Switch
- Electronic Inductor/Gyrator Circuit
- Surge Protection
- V.32 bis/V.34 Compatible
- PTT and Safety Regulations in France
- PC Board Mountable
- FCC Compatible

Applications

- Home Medical Devices
- Plant Monitoring Equipment
- Security/Alarm Systems
- Utility Meters
- Modems
- Voice Mail Systems
- Vending Machines
- Elevator Control Boxes
- Network Routers
- PBX Systems
- PC Mother Boards
- Telephony Applications
- Digital Telephone Answering Machines

Description

IXYS Integrated Circuits Division's CYG2110 DAA Module, designed for use in France, provides a complete telephone line interface circuit in a small (1.07" x 1.07" x 0.4") package. The module provides a fast and cost-effective solution for designs that require an interface to the telephone line.

The CYG2110 is designed to meet PTT and safety regulations in France. Select the CYG2100 for use in most other EU nations, except Spain.

Approvals

- EN/IEC 60950 Compliant

Ordering Information

Part	Description
CYG2110	CYBERGATE Module (France only) (18/Tube)

Typical Application

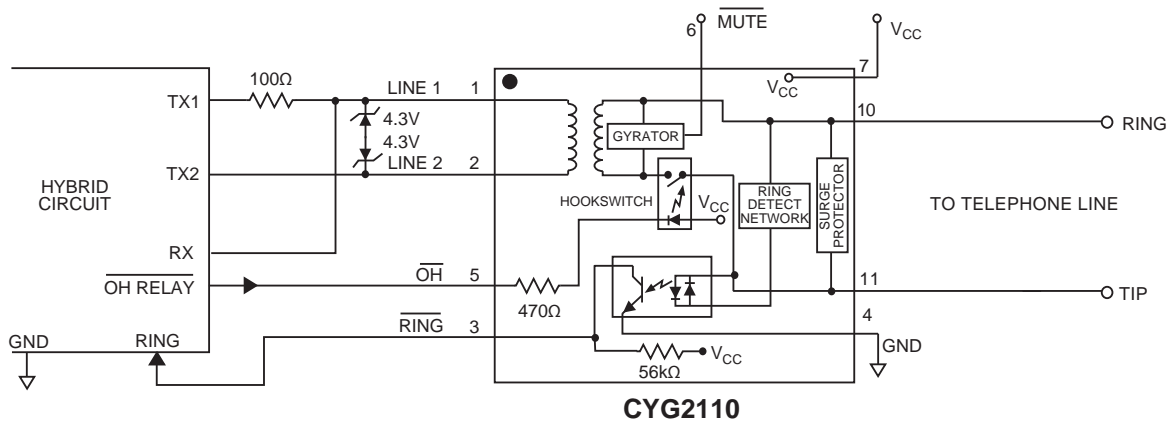

1 Specifications

1.1 Absolute Maximum Ratings @ 25°C

Symbol	Ratings	Units
Isolation Voltage, Input to Output	1500	V _{rms}
Tip/Ring Load Current (Continuous)	120	mA
Hook Switch LED Drive Current	50	mA
Hook Switch LED Reverse Voltage	5	V
Ring Detect Phototransistor Voltage V _{CC}	20	V
Relative Humidity (non-condensing)	10-85	%
Operational Temperature	0-70	°C
Storage Temperature	0-100	°C

Absolute maximum ratings are stress ratings. Stresses in excess of these ratings can cause permanent damage to the device. Functional operation of the device at conditions beyond those indicated in the operational sections of this data sheet is not implied.

1.2 DC Electrical Characteristics @ 25°C (Unless Otherwise Noted)

Parameter	Conditions	Minimum	Typical	Maximum	Units
On-Hook Impedance	@100V _{DC} Across Pins 11, 10 (T, R)	10	-	-	MΩ
Off-Hook Line Leakage Current	@100V _{DC} Across Pins 11, 10 (T, R)	-	-	10	μA
Hook Switch Resistance	$\overline{OH} = \text{GND}, V_{CC} = +5V_{DC}$	-	-	35	Ω
Off-Hook Supply Current	$\overline{OH} = \text{GND}, V_{CC} = +5V_{DC}$	7	8	9	mA
Hook Switch Power Source, Pin 5 ¹	-	4.75	5	12	V
DC Loop Current	$\overline{OH} = \text{GND}, V_{CC} = +5V_{DC}$	5	-	120	mA

¹ For V_{CC} > +12V, select an external resistor (R) such that ((V_{CC} - 1.4) / R) < 50mA

1.3 AC Signal Path Electrical Characteristics @ 25°C (Unless Otherwise Noted)

Parameter	Conditions	Minimum	Typical	Maximum	Units
Return Loss	$\overline{OH} = \text{GND}, 300\text{Hz to } 3500\text{Hz} (600\Omega)$	14	25	-	dB
Insertion Loss Transmit Receive	$\overline{OH} = \text{GND}, 300\text{Hz to } 3500\text{Hz} (600\Omega)$	-	-	7	dB
Frequency Response	$\overline{OH} = \text{GND}, 300\text{Hz to } 3500\text{Hz}$	-0.25	-	+0.25	dB
Longitudinal Balance On-Hook Off-Hook	$\overline{OH} = V_{CC}$ $\overline{OH} = \text{GND}$	60 40	- -	- -	dB
Total Harmonic Distortion	$\overline{OH} = \text{GND}, -10\text{dBm}, f=350\text{Hz}$	-	-	0.01	%
Secondary Load Impedance	Line 1 & Line 2	-	100	-	Ω
Primary Source Impedance	Tip & Ring	-	600	-	Ω

1.4 Ring Detection Circuit Electrical Characteristics @ 25°C (Unless Otherwise Noted)

Parameter	Conditions	Minimum	Typical	Maximum	Units
Ringing Voltage Detection Range	-	29	-	150	V _{rms}
Ringing Frequency Detection Range	-	15	-	70	Hz
Ringing Impedance	f = 25Hz	-	18	-	kΩ
RING (Pin 9) Output Voltage (Pulsed)					
Logic "0", Ring Present	-	-	-	0.8	V
Logic "1", Ring Not Present	-	-	-	V _{CC}	

1.5 Surge, Transient, and Isolation Electrical Characteristics @ 25°C (Unless Otherwise Noted)

Parameter	Conditions	Minimum	Typical	Maximum	Units
Surge Protection Voltage Tip & Ring (Pins 11, 10)	-	-	-	300	V
Isolation Voltage, Pins (1, 2, 3, 4, 5, 6, 7) to (10, 11)	-	-	-	1500	V _{rms}

1.6 Test Circuits

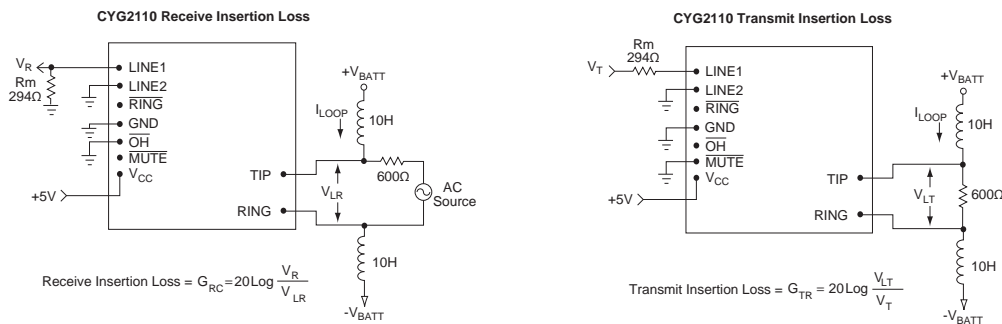

1.7 CYG2110 Pinouts and Definitions

Pinouts	Pin#	I/O	Name	Function
<div style="border: 1px solid black; padding: 5px; width: fit-content;"> <input type="checkbox"/> LINE 1 (PIN 1) <input type="checkbox"/> LINE 2 <input type="checkbox"/> RING <input type="checkbox"/> GND <input type="checkbox"/> OH <input type="checkbox"/> MUTE <input type="checkbox"/> V_{CC} </div> <div style="margin-top: 10px;"> <input type="checkbox"/> TIP <input type="checkbox"/> RING </div> <p>Top View</p>	1	I/O	LINE 1	Transformer isolated winding connection 1.
	2	I/O	LINE 2	Transformer isolated winding connection 2.
	3	O	RING	Active low indicates incoming ring signal. This is pulsed low by the AC ring signal, and is not a steady-state low during ringing.
	4	I	GND	Return Path for V _{CC}
	5	I	OH	Driving this pin low asserts the off-hook condition. The hook switch LED is current limited by an internal 470Ω resistor.
	6	I	MUTE	Not Used
	7	I	V _{CC}	Provides power to the hook switch LED. Voltage is usually +5V (for 8mA LED current), but can be higher if an external resistor is placed in series with the internal 470Ω resistor.
	10	I/O	RING	Connection to telephone line Ring conductor.
	11	I/O	TIP	Connection to telephone line Tip conductor.

2 Manufacturing Information

2.1 Handling and Assembly Recommendations

The CYG2110 is not hermetically sealed, and should not be exposed to any liquid-based rinsing processes. IXYS Integrated Circuits Division recommends two (2) approaches: (1) the modem should be installed in a wave-soldering process that uses a no-clean soldering flux that will mostly evaporate during the normal wave-soldering processes, (2) the modem should be soldered in by hand after the rest of the card is wave-soldered.

2.2 Reflow Profile

This product has a maximum solder temperature as shown below.

Device	Maximum Temperature
CYG2110	260°C

2.3 Mechanical Dimensions

2.3.1 CYG2110

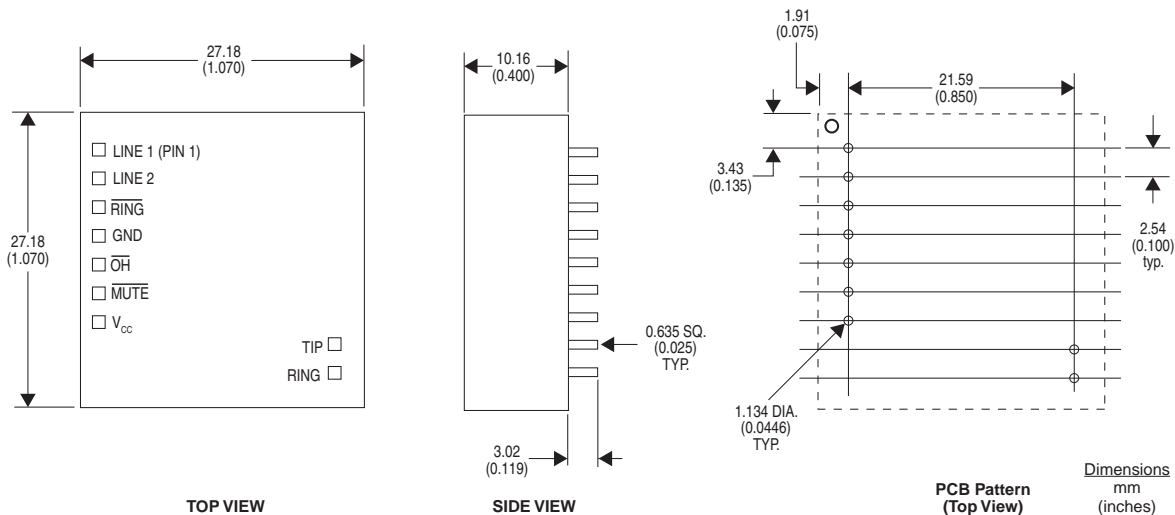

For additional information please visit our website at: www.ixysic.com

IXYS Integrated Circuits Division makes no representations or warranties with respect to the accuracy or completeness of the contents of this publication and reserves the right to make changes to specifications and product descriptions at any time without notice. Neither circuit patent licenses nor indemnity are expressed or implied. Except as set forth in IXYS Integrated Circuits Division's Standard Terms and Conditions of Sale, IXYS Integrated Circuits Division assumes no liability whatsoever, and disclaims any express or implied warranty, relating to its products including, but not limited to, the implied warranty of merchantability, fitness for a particular purpose, or infringement of any intellectual property right.

The products described in this document are not designed, intended, authorized or warranted for use as components in systems intended for surgical implant into the body, or in other applications intended to support or sustain life, or where malfunction of IXYS Integrated Circuits Division's product may result in direct physical harm, injury, or death to a person or severe property or environmental damage. IXYS Integrated Circuits Division reserves the right to discontinue or make changes to its products at any time without notice.

Specification: DS-CYG2110-R03
 ©Copyright 2019, IXYS Integrated Circuits Division
 All rights reserved. Printed in USA.
 1/31/2019