

Characteristics

Parameter	Rating	Units
Blocking Voltage	60	V _P
Load Current, T _A =25°C:		
With 5°C/W Heat Sink	11.85	A _{DC}
No Heat Sink	4	
On-Resistance (max)	0.08	Ω
Thermal Impedance, Junction-to-Case, θ _{JC}	0.35	°C/W

Features

- 11.85A_{DC} Load Current with 5°C/W Heat Sink
- Low 0.08Ω On-Resistance
- 60V_P Blocking Voltage
- 2500V_{rms} Input/Output Isolation
- Low Thermal Impedance: θ_{JC} = 0.35 °C/W
- Isolated, Low Thermal Impedance Ceramic Pad for Heat Sink Applications
- Low Drive Power Requirements
- No EMI/RFI Generation
- Flammability Rating UL 94 V-0

Applications

- Industrial Controls / Motor Control
- Robotics
- Medical Equipment—Patient/Equipment Isolation
- Instrumentation
- Multiplexers
- Data Acquisition
- Electronic Switching
- I/O Subsystems
- Meters (Watt-Hour, Water, Gas)
- Transportation Equipment

Approvals

- UL 508 Certified Component: File E69938

Pin Configuration

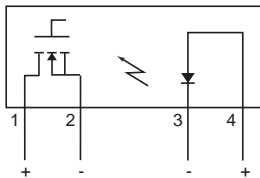

Description

IXYS Integrated Circuits brings OptoMOS® technology, reliability and compact size to a new family of High Power Solid State Relays. As part of this new family, the CPC1708J single-pole normally open (1-Form-A) DC Solid State Relay employs optically coupled MOSFET technology to provide 2500V_{rms} of input to output isolation.

The relay output is constructed with efficient MOSFET switches that use IXYS Integrated Circuits' patented OptoMOS architecture. The input, a highly efficient infrared LED, controls the optically coupled output. Low on-resistance and high load current handling capability make this relay suitable for a variety of high performance DC switching applications.

The unique i4-PAC package pioneered by IXYS enables solid state relays to achieve the highest load current and power ratings. This package features an IXYS-unique process where the silicon chips are soft soldered onto the Direct Copper Bond (DCB) substrate instead of the usual copper leadframe. The DCB ceramic, the same substrate used in high power modules, not only provides 2500V_{rms} isolation but also very low junction-to-case thermal impedance (0.35°C/W).

Ordering Information

Part	Description
CPC1708J	i4-PAC Package (25 per tube)

Switching Characteristics

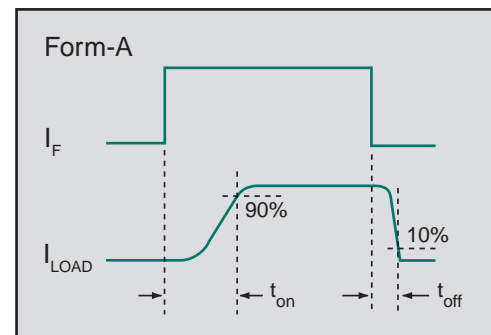

1 Specifications

1.1 Absolute Maximum Ratings @ 25°C

Parameter	Symbol	Rating	Unit
Blocking Voltage	V_L	60	V_P
Reverse Input Voltage	V_R	5	V
Input Control Current, Continuous Peak (10ms)	I_F	50	mA
		1	A
Input Power Dissipation	P_{IN}	150	mW
Isolation Voltage (Input to Output)	V_{ISO}	2500	V_{rms}
Operating Temperature, Ambient	T_A	-40 to +85	°C
Storage Temperature	-	-40 to +125	°C

Absolute maximum ratings are stress ratings. Stresses in excess of these ratings can cause permanent damage to the device. Functional operation of the device at conditions beyond those indicated in the operational sections of this data sheet is not implied.

Typical values are characteristic of the device at +25°C, and are the result of engineering evaluations. They are provided for information purposes only, and are not part of the manufacturing testing requirements.

1.2 Electrical Characteristics @ 25°C

Parameter	Conditions	Symbol	Minimum	Typical	Maximum	Units
Output Characteristics						
Blocking Voltage	$I_L=1\mu A$	V_{DRM}	60	-	-	V
Load Current ¹ Peak Continuous Continuous Continuous	$t \leq 10ms$	I_L	-	-	30	A_P
	No Heat Sink				4	A_{DC}
	$T_C=25^\circ C$	24				
	$T_C=99^\circ C$	$I_{L(99)}$			5.35	
On-Resistance ²	$I_F=10mA, I_L=1A$	R_{ON}	-	0.05	0.08	Ω
Off-State Leakage Current	$V_L=60V_P$	I_{LEAK}	-	-	1	μA
Switching Speeds Turn-On Turn-Off	$I_F=20mA, V_L=10V$	t_{on}	-	5	20	ms
		t_{off}	-	0.13	5	
Output Capacitance	$I_F=0mA, V_L=25V, f=1MHz$	C_{out}	-	1250	-	pF
Input Characteristics						
Input Control Current to Activate ³	$I_L=1A$	I_F	-	-	10	mA
Input Control Current to Deactivate	-	I_F	0.6	-	-	mA
Input Voltage Drop	$I_F=10mA$	V_F	0.9	1.42	1.56	V
Reverse Input Current	$V_R=5V$	I_R	-	-	10	μA
Input/Output Characteristics						
Capacitance, Input-to-Output	$V_{IO}=0V, f=1MHz$	C_{IO}	-	1	-	pF

¹ Higher load currents possible with proper heat sinking.

² Measurement taken within 1 second of on-time.

³ For applications requiring high temperature operation (> 60°C) a minimum LED drive current of 20mA is recommended.

2 Thermal Characteristics

Parameter	Conditions	Symbol	Rating	Units
Thermal Impedance (Junction to Case)	-	θ_{JC}	0.35	$^{\circ}\text{C}/\text{W}$
Thermal Impedance (Junction to Ambient)	Free Air	θ_{JA}	45	$^{\circ}\text{C}/\text{W}$
Junction Temperature (Operating)	-	T_J	-40 to +100	$^{\circ}\text{C}$

2.1 Thermal Management

Device high current characterization was performed using Kunze heat sink KU 1-159, phase change thermal interface material KU-ALC 5, and transistor clip KU 4-499/1. This combination provided an approximate junction-to-ambient thermal impedance of $12.5^{\circ}\text{C}/\text{W}$.

2.2 Heat Sink Calculation

Higher load currents are possible by using lower thermal impedance heat sink combinations.

Heat Sink Rating

$$\theta_{CA} = \frac{(T_J - T_A) I_{L(99)}^2}{I_L^2 \cdot P_{D(99)}} - \theta_{JC}$$

T_J = Junction Temperature ($^{\circ}\text{C}$), $T_J \leq 100^{\circ}\text{C}$ *

T_A = Ambient Temperature ($^{\circ}\text{C}$)

$I_{L(99)}$ = Load Current with Case Temperature @ 99°C (A_{DC})

I_L = Desired Operating Load Current (A_{DC}), $I_L \leq I_{L(MAX)}$

θ_{JC} = Thermal Impedance, Junction to Case ($^{\circ}\text{C}/\text{W}$) = $0.35^{\circ}\text{C}/\text{W}$

θ_{CA} = Thermal Impedance of Heat Sink & Thermal Interface Material, Case to Ambient ($^{\circ}\text{C}/\text{W}$)

$P_{D(99)}$ = Maximum power dissipation with case temperature held at 99°C = 2.86W

* Elevated junction temperature reduces semiconductor lifetime.

NOTE: The exposed surface of the DCB substrate is not to be soldered.

3 Performance Data*

Unless otherwise specified, all data was collected without the use of a heat sink.

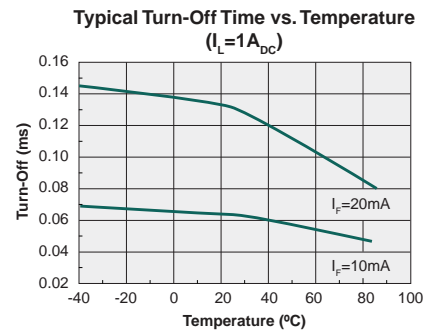
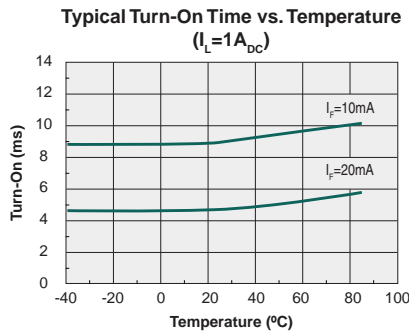
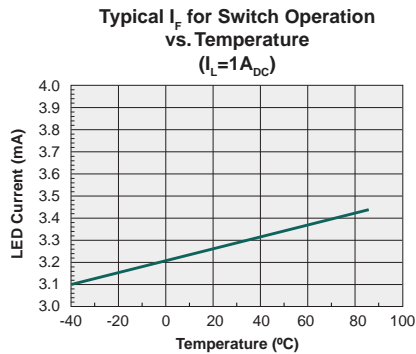
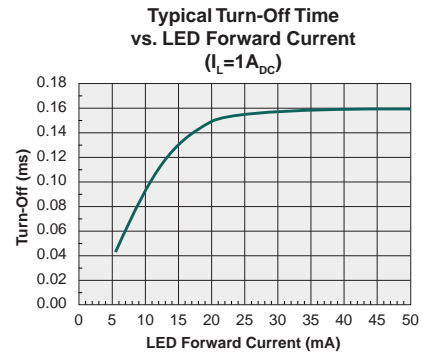
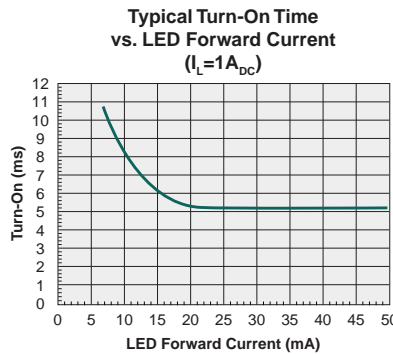
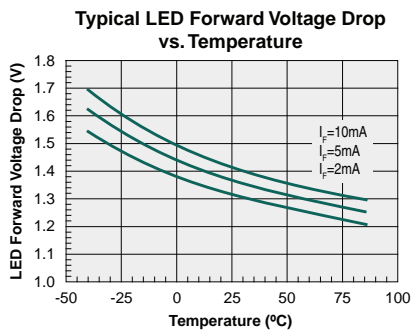
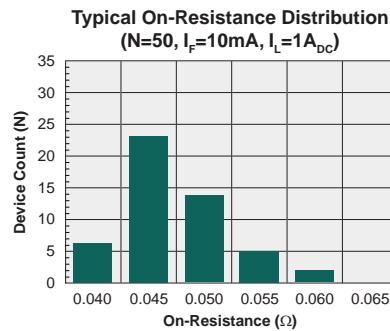
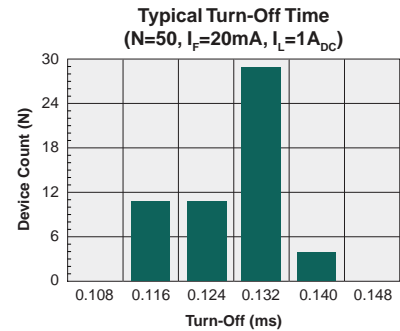
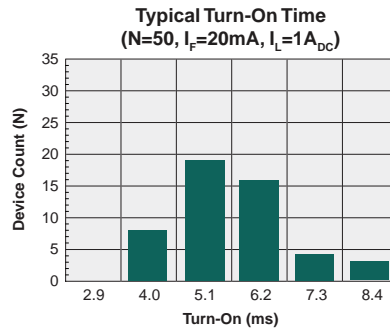
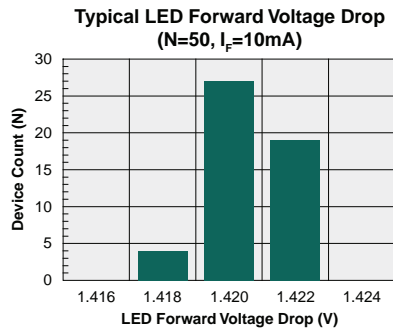

* Unless otherwise noted, data presented in these graphs is typical of device operation at 25°C.

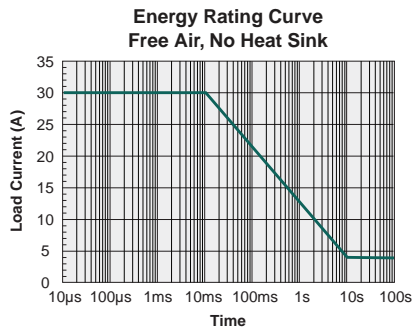
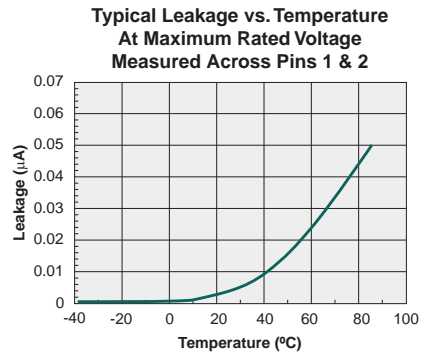
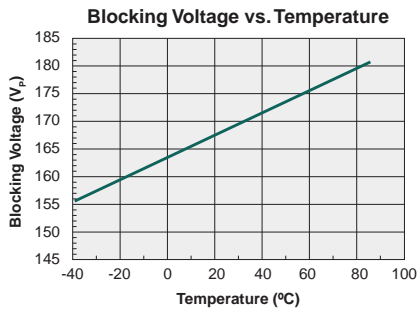
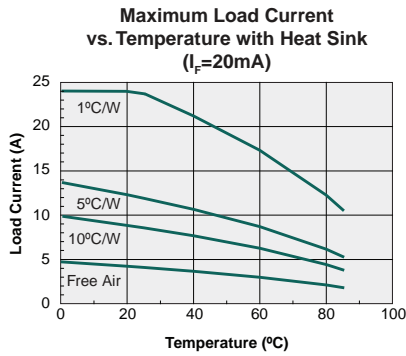
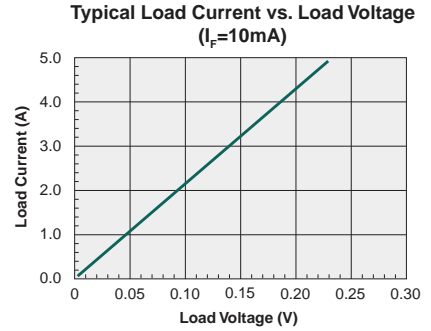
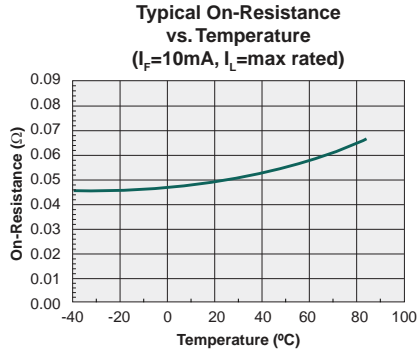
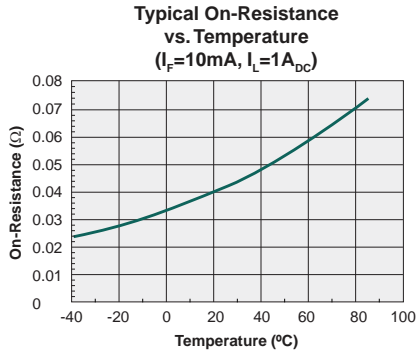

Unless otherwise noted, data presented in these graphs is typical of device operation at 25°C.

4 Manufacturing Information

4.1 ESD Sensitivity



This product is **ESD Sensitive**, and should be handled according to the industry standard **JESD-625**.

4.2 Soldering Profile

For through-hole devices, the maximum pin temperature and maximum dwell time through all solder waves is provided in the table below. Dwell time is the interval beginning when the pins are initially immersed into the solder wave until they exit the solder wave. For multiple waves, the dwell time is from entering the first wave until exiting the last wave. During this time, pin temperatures must not exceed the maximum temperature given in the table below. Body temperature of the device must not exceed the limit shown in the table below at any time during the soldering process.

Device	Maximum Pin Temperature	Maximum Body Temperature	Maximum Dwell Time	Wave Cycles
CPC1708J	260°C	245°C	10 seconds*	1

*Total cumulative duration of all waves.

NOTE: The exposed surface of the DCB substrate must not be soldered.

4.3 Board Wash

IXYS Integrated Circuits recommends the use of no-clean flux formulations. Board washing to reduce or remove flux residue following the solder reflow process is acceptable provided proper precautions are taken to prevent damage to the device. These precautions include but are not limited to: using a low pressure wash and providing a follow up bake cycle sufficient to remove any moisture trapped within the device due to the washing process. Due to the variability of the wash parameters used to clean the board, determination of the bake temperature and duration necessary to remove the moisture trapped within the package is the responsibility of the user (assembler). Cleaning or drying methods that employ ultrasonic energy may damage the device and should not be used. Additionally, the device must not be exposed to halide flux or solvents.



4.4 Mechanical Dimensions

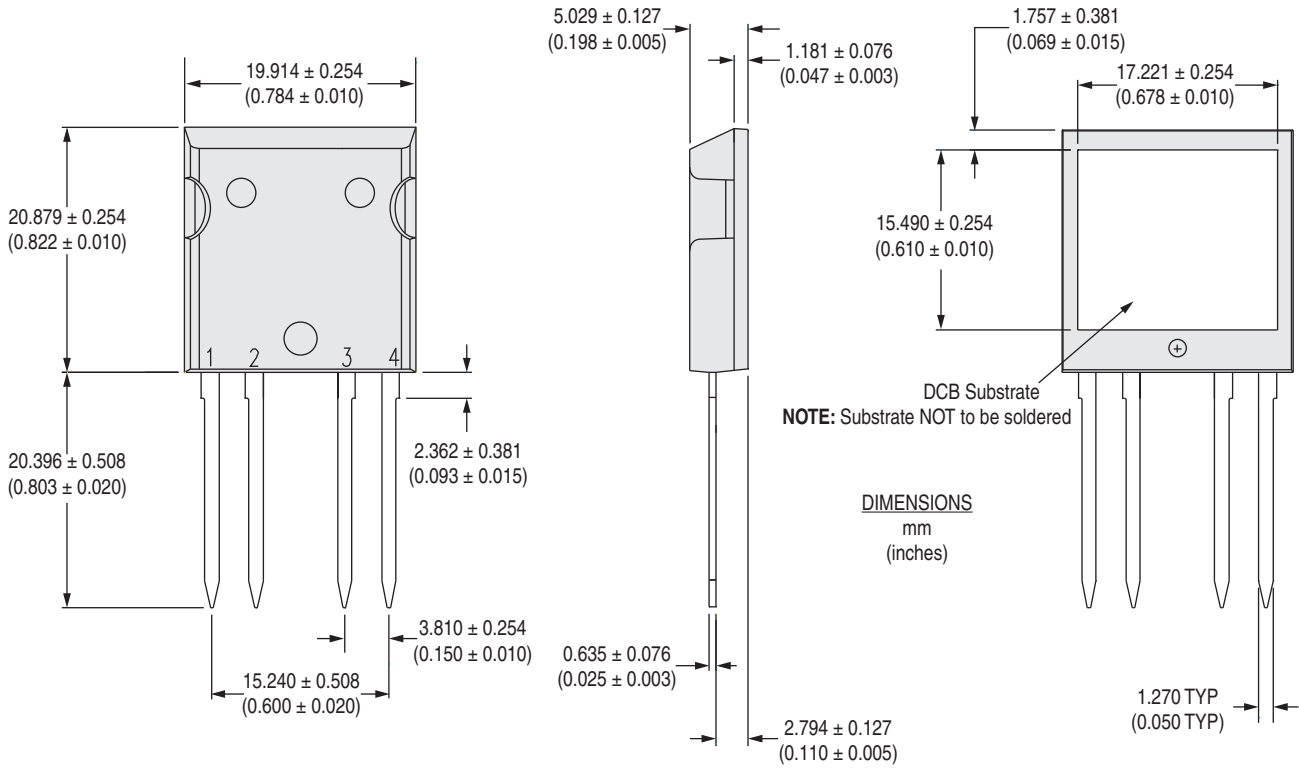

- NOTES:**
1. Controlling dimension: Inches.
 2. Metallized external surface of DCB substrate maintains 2500V_{rms} isolation to device internal structure and all external pins.

For additional information please visit our website at: <https://www.ixysic.com>