



**健隆投資有限公司**  
**STRONG BASE INVESTMENT LTD.**

Unit 17, 11/F., Hewlett Centre, 52-54 Hoi Yuen Road, Kwun Tong, Kowloon, Hong Kong.  
Tel: (852) 2793 3293 Fax: (852) 2793 3096



**Approval Sheet**  
**(確認書)**

<b>編號</b> <b>Ref. No.</b>	
<b>日期</b> <b>Issued Date</b>	2019-1-15

**公司名稱** : \_\_\_\_\_  
Company Name

**產品編號** : 3G4UTB-8  
Part No.

**產品種類** : LED-LAMP  
Category

**產品描述** : 3MM/ SUPER BRIGHT YELLOW GREEN ,GREEN CLEAR  
Description

**客戶產品編號** : \_\_\_\_\_  
Customer No.

**備注** : \_\_\_\_\_  
Remarks

STRONG BASE			
ISSUER	APPROVER	CHECKER	ENGINEER
	朱美丽	覃寿芝	高雪

Authorized Signature 客戶簽字				
部門 Department				
簽字 Signature				

工廠名稱:字之亮電子(深圳)有限公司  
工廠地址:廣東省深圳市龍崗區橫崗鎮荷坳村金源工業區  
Company Name: Pretty Light (Shen Zhen) Limited  
Factory Address:jin-Yuan,Industrial Zone He-Ao Cun,Heng-Gang  
Zhen Long-Gang Area,Shen-Zhen City,  
TEL: (755) 8976 6931 2862 5421 FAX: (755) 28684819 2862 5922

**PART NO. : 3G4UTB-8**

**DATE : 15 January 2019**

**3MM/ SUPER BRIGHT YELLOW GREEN ,GREEN CLEAR**

**SPECIFICATION**

**ABSOLUTE MAXIMUM RATING (Ta=25°C)**

Item	Symbol	Rating	Unit
Power Dissipation	P <sub>D</sub>	80	mW
Forward Current	I <sub>F</sub>	20	mA
Peak Forward Current (1/10 Duty Cycle, 0.1 ms Pulse Width)	I <sub>FP</sub>	100	mA
Reverse Voltage	V <sub>R</sub>	5	V
Operating Temperature	T <sub>opr</sub>	-40~+80	°C
Storage Temperature	T <sub>stg</sub>	-40~+80	°C

**ELECTRICAL/OPTICAL CHARACTERISTICS RATING (Ta=25°C)**

Item	Symbol	Test Conditions	Rating			Unit
			Min.	Typ.	Max.	
Forward Voltage	V <sub>F</sub>	I <sub>F</sub> =20mA	1.7	2.1	2.4	V
Reverse Current	I <sub>R</sub>	V <sub>R</sub> =5V	---	---	10	μA
Luminous Intensity	I <sub>v</sub>	I <sub>F</sub> =20mA	---	500	---	mcd
Dominant Wave Length	λ <sub>d</sub>	I <sub>F</sub> =20mA	---	570	---	nm
Viewing Angle 2 θ <sub>1/2</sub>	2 θ <sub>1/2</sub>	I <sub>F</sub> =20mA	20°			deg.

**Notes:-**

1) θ<sub>1/2</sub> is the off-axis angle where the luminous intensity is half the optical centerline value.

**Soldering Conditions** : Soldering Temp. ≤ 260°C

Soldering Time ≤ 5 Sec.



**Caution** : ESD protection measures shall be considered and taken in the initial design stage, because static electricity and surge could damage the LED.  
 A wrist band or an anti-electrostatic glove should be used when handling Electrostatic Sensitive Devices.

**PART NO. : 3G4UTB-8**

**DATE : 15 January 2019**

**3MM/ SUPER BRIGHT YELLOW GREEN ,GREEN CLEAR**

**PACKAGE DIMENSION**

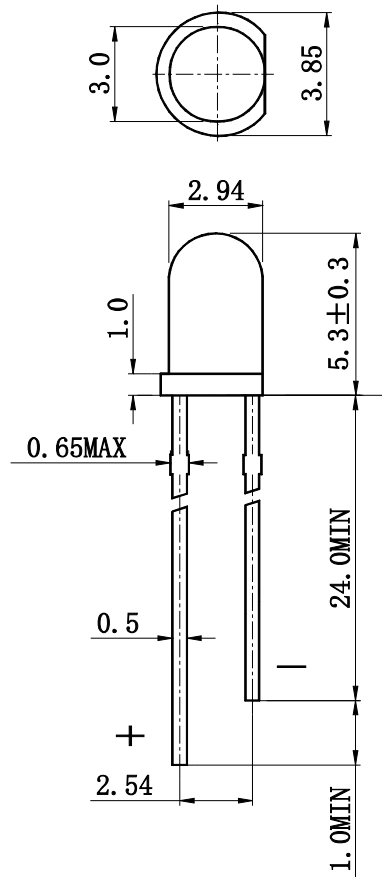
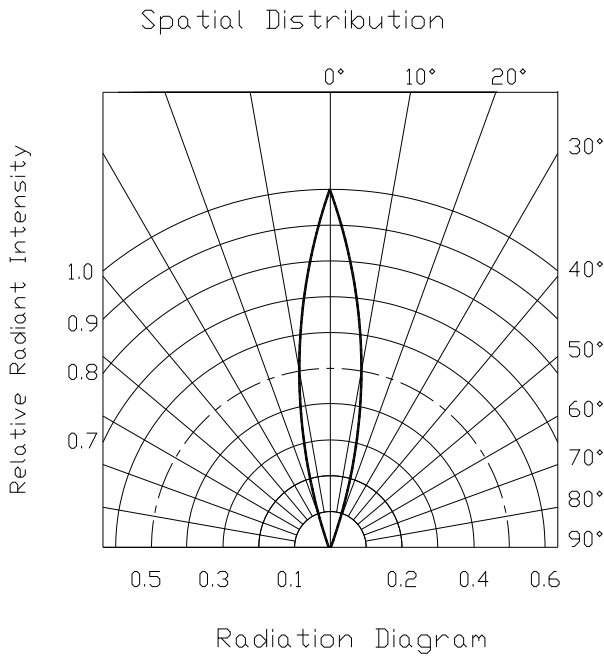

**Tolerance: ± 0.25(0.01)**  
**Unit: mm(inch)**

Item	Materials
Resin(Mold)	Epoxy Resin
Lead Frame	Copper Alloy

Part Number	Emitting Color	Lens Type
3G4UTB-8	YELLOW GREEN	GREEN CLEAR

**PART NO. : 3G4UTB-8**

**DATE : 15 January 2019**

**3MM/ SUPER BRIGHT YELLOW GREEN ,GREEN CLEAR**

**Typical Electrical/Optical Characteristics Curves**

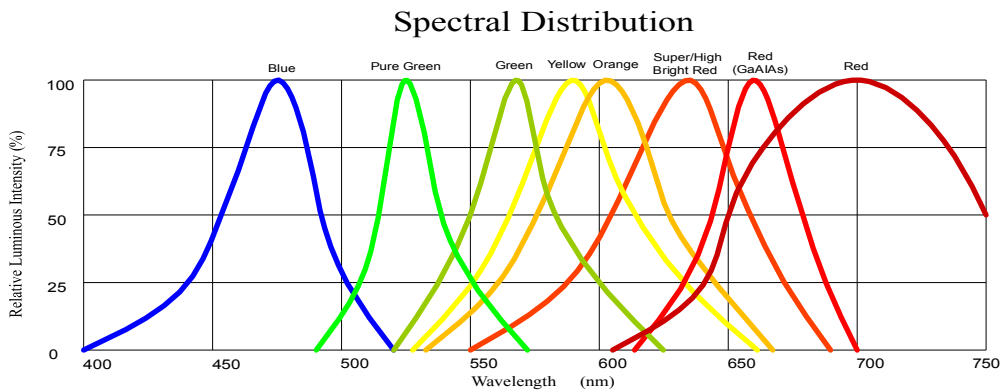

(25°C) Ambient Temperature Unless Otherwise Noted

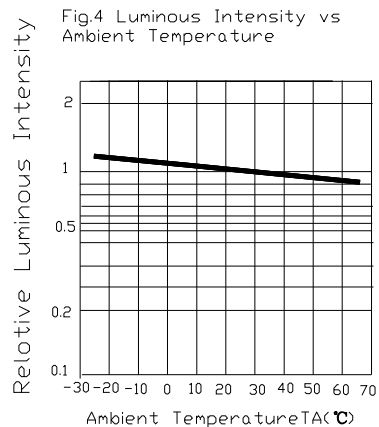
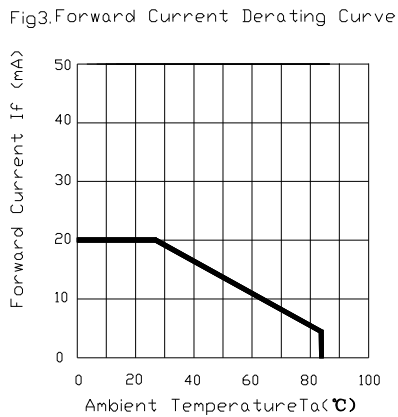
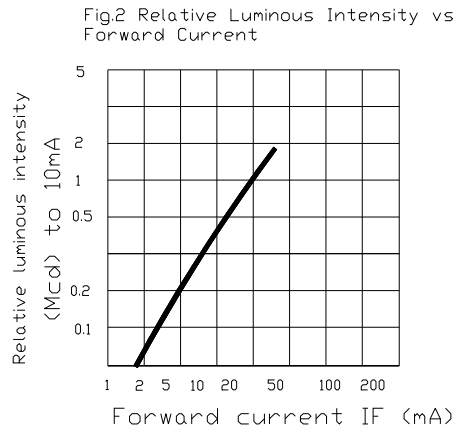
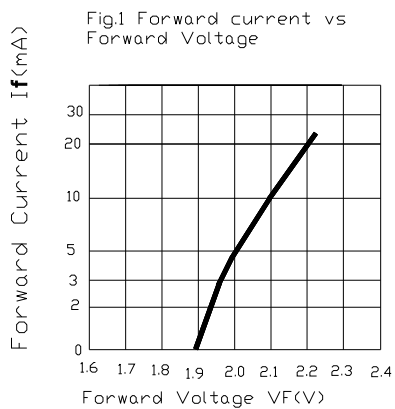

**PART NO. : 3G4UTB-8**

**DATE : 15 January 2019**

3MM/ SUPER BRIGHT YELLOW GREEN ,GREEN CLEAR

LED lamp use explain

If there are 2 lights lamp use, according to the (PRETTY LIGHT) each small packaging labeled BIN to separate the use.

此产品在多颗使用时, 需按照字之亮每小包上标示的 BIN 级来分开使用