



P4HE3.3A~P4HE14A

SURFACE MOUNT TRANSIENT VOLTAGE SUPPRESSOR

Voltage

3.3~14 V

Power

400 W

SOD-123HE

Unit : inch(mm)

Features

- For surface mounted applications in order to optimize board space.
- Ultra thin profile package for space constrained utilization.
- Package suitable for automated handling
- Low inductance
- High temperature soldering : 260°C/10 seconds at terminals
- Lead free in compliance with EU RoHS 2011/65/EU directive.
- Green molding compound as per IEC61249 Std.(Halogen Free)

Mechanical Data

- Case: SOD-123HE, Plastic
- Terminals: Solderable per MIL-STD-750, Method 2026
- Polarity: Color band denotes cathode end
- Approx. Weight: 0.0006 ounces, 0.0184 grams

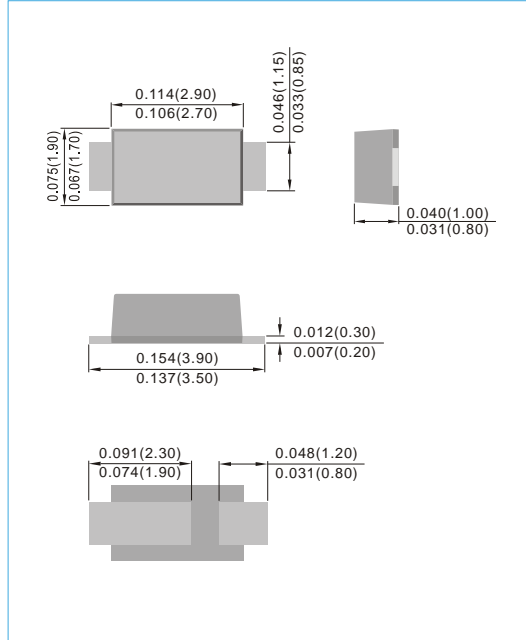
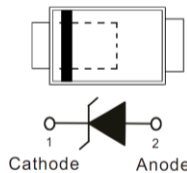

Maximum Ratings ($T_A=25^\circ\text{C}$ unless otherwise noted)

PARAMETER	SYMBOL	LIMIT	UNITS
Peak Pulse Power Dissipation($t_p=10/1000\mu\text{s}$) ^(NOTE 1,2)	P_{PP}	400	W
Peak Forward Surge Current (8.3ms single half sine-wave)	I_{FSM}	40	A
Peak Pulse Current on $t_p=10/1000\mu\text{s}$ waveform ^(NOTE1, Fig.2)	I_{PPM}	See table 1	A
ESD IEC61000-4-2(Air)	V_{ESD}	± 30	kV
ESD IEC61000-4-2(Contact)		± 30	
Typical Thermal Resistance Junction to Ambient ^(NOTE2)	$R_{\theta JA}$	107	$^\circ\text{C/W}$
Operating Junction Temperature Range	T_J	-55 to +150	$^\circ\text{C}$
Storage Temperature Range	T_{STG}	-55 to +150	$^\circ\text{C}$

Notes :

1. Non-repetitive current pulse, per Fig.3 and derated above $T_A=25^\circ\text{C}$ per Fig.2
2. Mounted on 5mm^2 copper pads to each terminal.
3. A transient suppressor is selected according to the working peak reverse voltage(V_{RWM}), which should be equal to or greater than the DC or continuous peak operation voltage level.
4. TVS is a transient protection device, it is strongly recommended not to use as a Zener.



P4HE3.3A~P4HE14A

Electrical Characteristics ($T_A=25^{\circ}\text{C}$ unless otherwise noted)

Part Number	V_{RWM}	V_{BR}			$I_R@V_{RWM}$	$V_C@I_{PP}$		Marking Code
		Min.	Max.	I_T		V	A	
	V	V	V	mA	μA			
P4HE3.3A	3.3	5.2	6	10	600	8.5	47	4F1
P4HE5.0A	5	6.40	7	10	400	9.2	43.5	4F2
P4HE6.0A	6	6.67	7.37	10	400	10.3	38.8	4F3
P4HE6.5A	6.5	7.22	7.98	10	250	11.2	35.7	4F4
P4HE7.0A	7	7.78	8.6	10	100	12	33.3	4F5
P4HE7.5A	7.5	8.33	9.21	1	50	12.9	31	4F6
P4HE8.0A	8	8.89	9.83	1	25	13.6	29.4	4F7
P4HE8.5A	8.5	9.44	10.4	1	10	14.4	27.8	4F8
P4HE9.0A	9	10	11.1	1	5	15.4	26	4F9
P4HE10A	10	11.1	12.3	1	2.5	17	23.5	4FA
P4HE11A	11	12.2	13.5	1	2.5	18.2	22	4FB
P4HE12A	12	13.3	14.7	1	2.5	19.9	20.1	4FC
P4HE13A	13	14.4	15.9	1	0.1	21.5	18.6	4FD
P4HE14A	14	15.6	17.2	1	0.1	23.2	17.2	4FE



P4HE3.3A~P4HE14A

TYPICAL CHARACTERISTIC CURVES

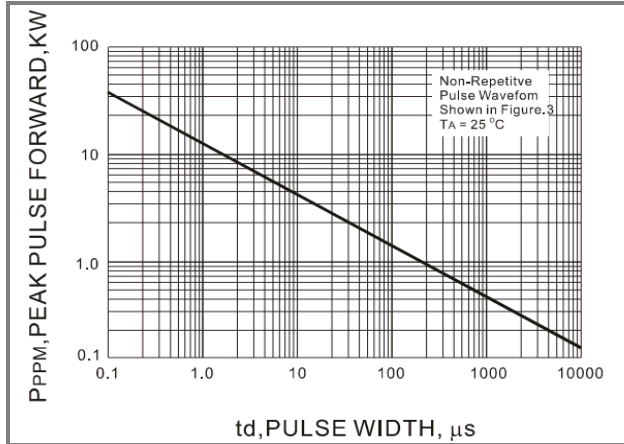

Fig.1 Peak Pulse Power Rating Curve

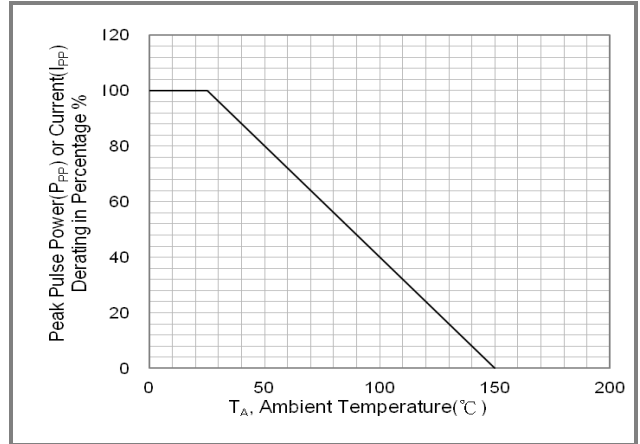

Fig.2 Derating Curve

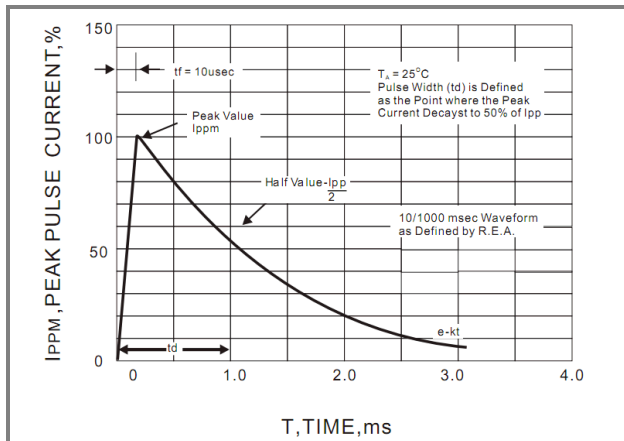

Fig.3 Pulse Waveform

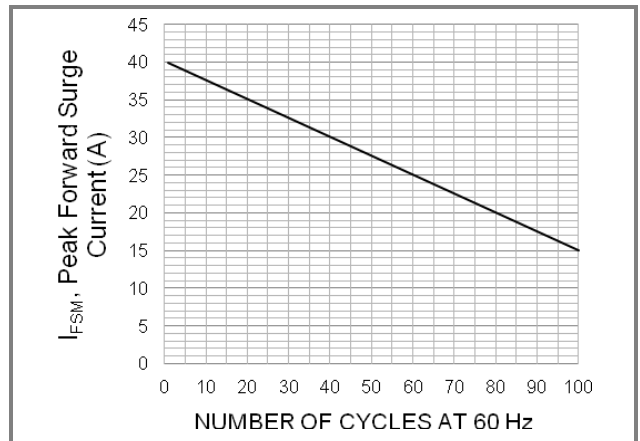

Fig.4 Maximum Non-repetitive Peak Forward Surge Current



P4HE3.3A~P4HE14A

PART NO PACKING CODE VERSION

Part No Packing Code	Package Type	Packing Type	Marking	Version
P4HE3.3A_R1_00001	SOD-123HE	3K pcs / 7" reel	4F1	Halogen free
P4HE3.3A_R2_00001	SOD-123HE	10K pcs / 13" reel	4F1	Halogen free

MOUNTING PAD LAYOUT

SOD-123HE Unit : inch(mm)

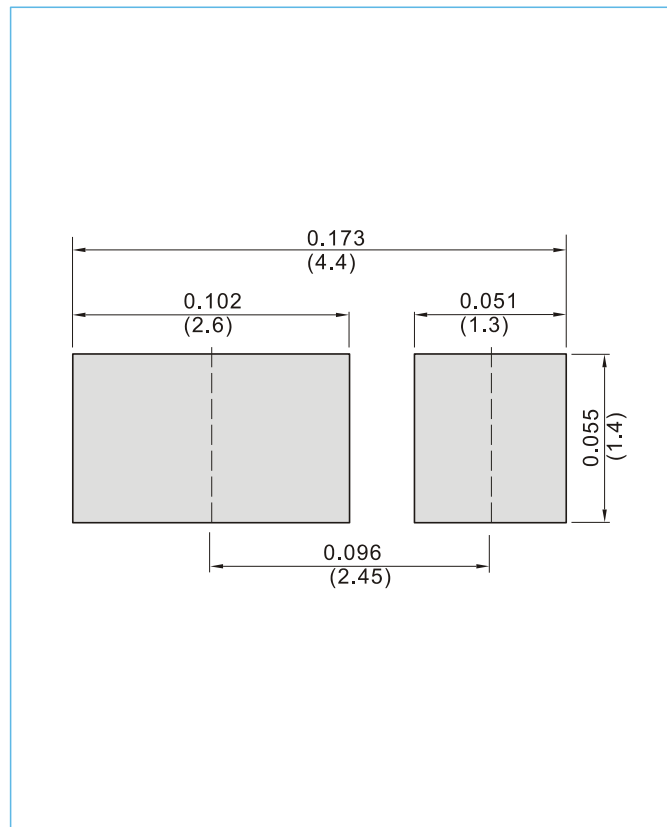



P4HE3.3A~P4HE14A

Disclaimer

- Reproducing and modifying information of the document is prohibited without permission from Panjit International Inc..
- Panjit International Inc. reserves the rights to make changes of the content herein the document anytime without notification. Please refer to our website for the latest document.
- Panjit International Inc. disclaims any and all liability arising out of the application or use of any product including damages incidentally and consequentially occurred.
- Panjit International Inc. does not assume any and all implied warranties, including warranties of fitness for particular purpose, non-infringement and merchantability.
- Applications shown on the herein document are examples of standard use and operation. Customers are responsible in comprehending the suitable use in particular applications. Panjit International Inc. makes no representation or warranty that such applications will be suitable for the specified use without further testing or modification.
- The products shown herein are not designed and authorized for equipments requiring high level of reliability or relating to human life and for any applications concerning life-saving or life-sustaining, such as medical instruments, transportation equipment, aerospace machinery et cetera. Customers using or selling these products for use in such applications do so at their own risk and agree to fully indemnify Panjit International Inc. for any damages resulting from such improper use or sale.
- Since Panjit uses lot number as the tracking base, please provide the lot number for tracking when complaining.