

Cree® J Series™ 5050 6-V, 9-V, 12-V, 24-V & 36-V LEDs



PRODUCT DESCRIPTION

J Series™ LEDs extend Cree’s industry-leading portfolio of lighting-class LEDs to a broader set of applications. The J Series 5050 LEDs deliver high-power light output, high efficacy and excellent value in a reliable package. The J Series 5050 LEDs are optimized for medium-density lighting applications where high efficacy and long lifetime are critical, such as street lights, outdoor area and indoor directional lights.

FEATURES

- Industry-compatible size: 5.0 x 5.0 x 0.7 mm
- 6-V, 9-V, 12-V, 24-V, and 36-V configurations
- Flux binned at 25 °C, chromaticity binned at 85 °C
- 6500 K–2700 K ANSI CCTs available
- 70, 80 & 90 CRI available for all CCTs
- RoHS and REACH compliant
- UL® recognized component (E495478)

PRODUCT SUMMARY

Product	Power Class	Test Temperature	Test Current	Typical Forward Voltage	4000 K, 70 CRI		3000 K, 80 CRI		Maximum Current
					Typical Flux	Typical Efficacy	Typical Flux	Typical Efficacy	
JR5050 6-V	5 W	25 °C	400 mA	5.8 V	420 lm	181 LPW	380 lm	164 LPW	1000 mA
JR5050 9-V	5 W	25 °C	260 mA	8.6 V	407 lm	182 LPW	369 lm	165 LPW	660 mA
JR5050 12-V	5 W	25 °C	200 mA	12.3 V	420 lm	171 LPW	380 lm	154 LPW	480 mA
JR5050 24-V	5 W	25 °C	100 mA	24.5 V	420 lm	171 LPW	380 lm	155 LPW	240 mA
JR5050 36-V	5 W	25 °C	65 mA	34.5 V	407 lm	181 LPW	369 lm	165 LPW	165 mA



J Series™ Products are sold exclusively by Cree Venture LED Company Limited (“Cree Venture”), regardless of geography. Any orders for J Series Products that are submitted to Cree, Inc. or any of its other subsidiaries will be directed to Cree Venture for acknowledgement and order fulfillment.

TABLE OF CONTENTS

Order Code & Bin Code Formats	3	Performance Groups - Luminous Flux	25
Characteristics - JR5050 6-V.....	4	Performance Groups - Forward Voltage.....	26
Operating Limits - JR5050 6-V	4	Performance Groups - Chromaticity	27
Flux Characteristics, Order Codes and Bins - JR5050 6-V.....	5	Reflow Soldering Characteristics.....	36
Relative Luminous Flux vs. Current - JR5050 6-V	6	Notes	37
Electrical Characteristics - JR5050 6-V	6	Mechanical Dimensions	39
Relative Chromaticity vs. Current - JR5050 6-V	7	Tape & Reel.....	40
Relative Chromaticity vs. Temperature - JR5050 6-V	7	Packaging.....	41
Characteristics - JR5050 9-V.....	8		
Operating Limits - JR5050 9-V	8		
Flux Characteristics, Order Codes and Bins - JR5050 9-V.....	9		
Relative Luminous Flux vs. Current - JR5050 9-V	10		
Electrical Characteristics - JR5050 9-V	10		
Relative Chromaticity vs. Current - JR5050 9-V	11		
Relative Chromaticity vs. Temperature - JR5050 9-V	11		
Characteristics - JR5050 12-V.....	12		
Operating Limits - JR5050 12-V	12		
Flux Characteristics, Order Codes and Bins - JR5050 12-V	13		
Relative Luminous Flux vs. Current - JR5050 12-V	14		
Electrical Characteristics - JR5050 12-V	14		
Relative Chromaticity vs. Current - JR5050 12-V	15		
Relative Chromaticity vs. Temperature - JR5050 12-V	15		
Characteristics - JR5050 24-V.....	16		
Operating Limits - JR5050 24-V	16		
Flux Characteristics, Order Codes and Bins - JR5050 24-V	17		
Relative Luminous Flux vs. Current - JR5050 24-V	18		
Electrical Characteristics - JR5050 24-V	18		
Relative Chromaticity vs. Current - JR5050 24-V	19		
Relative Chromaticity vs. Temperature - JR5050 24-V	19		
Characteristics - JR5050 36-V.....	20		
Operating Limits - JR5050 36-V	20		
Flux Characteristics, Order Codes and Bins - JR5050 36-V	21		
Relative Luminous Flux vs. Current - JR5050 36-V	22		
Electrical Characteristics - JR5050 36-V	22		
Relative Chromaticity vs. Current - JR5050 36-V	23		
Relative Chromaticity vs. Temperature - JR5050 36-V	23		
Relative Spectral Power Distribution	24		
Relative Luminous Flux vs. Junction Temperature.....	24		
Typical Spatial Distribution.....	25		

ORDER CODE & BIN CODE FORMATS

Order codes and bin codes for J Series 5050 LEDs are configured in the following manner:

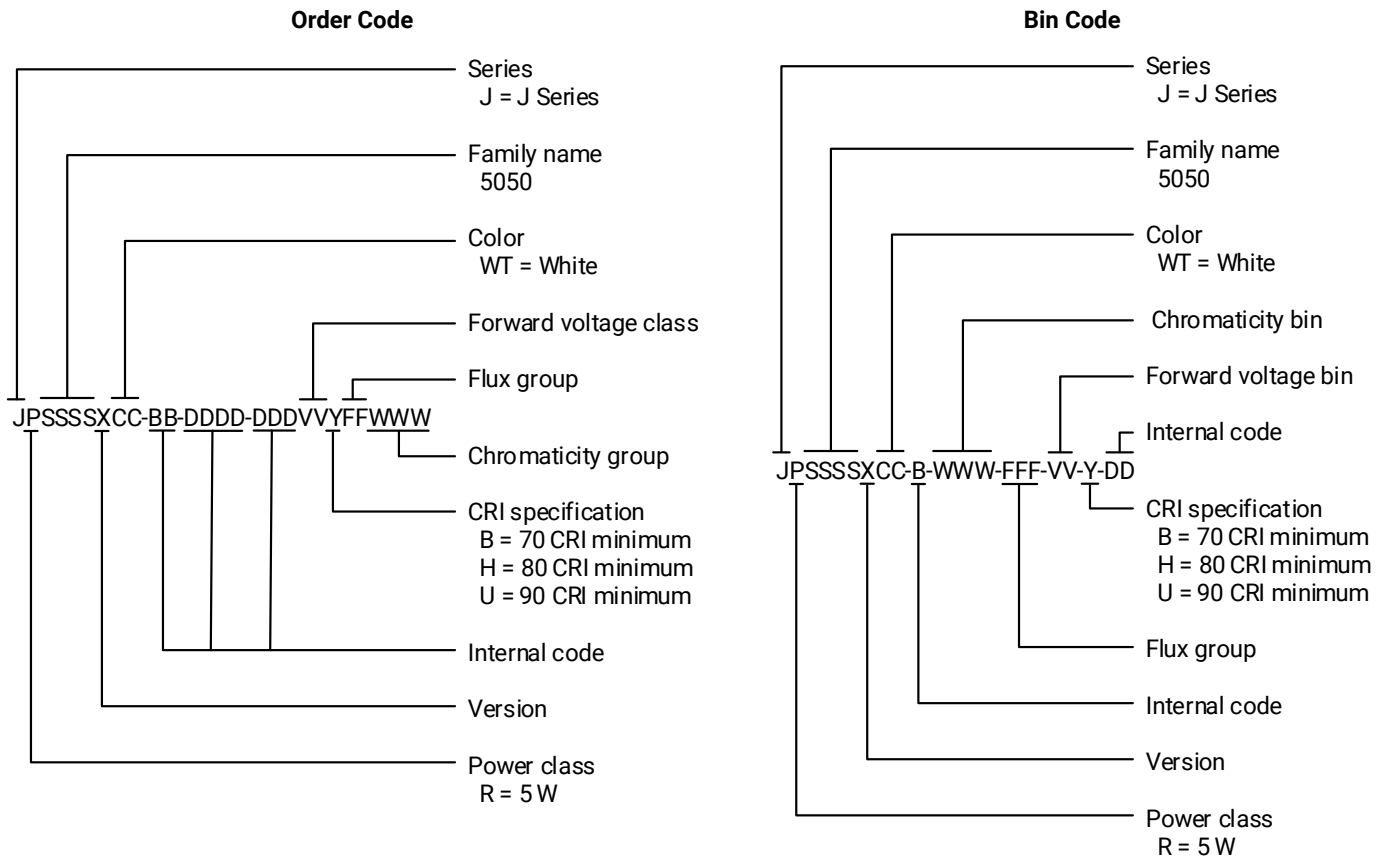

CHARACTERISTICS - JR5050 6-V

Characteristics	Unit	Minimum	Typical	Maximum
Thermal resistance, junction to solder point	°C/W		3	
Viewing angle (FWHM)	degrees		120	
Temperature coefficient of voltage	mV/°C		-2	
ESD withstand voltage (JEDEC JS-001-2012)	V		Class 2	
DC forward current	mA			1000
Reverse voltage	V			5
Forward voltage (@ 400 mA, 25 °C)	V		5.8	6.0
LED junction temperature	°C			125
Operating temperature	°C	-40		105

OPERATING LIMITS - JR5050 6-V

The maximum forward current is determined by the thermal resistance between the LED junction and ambient.

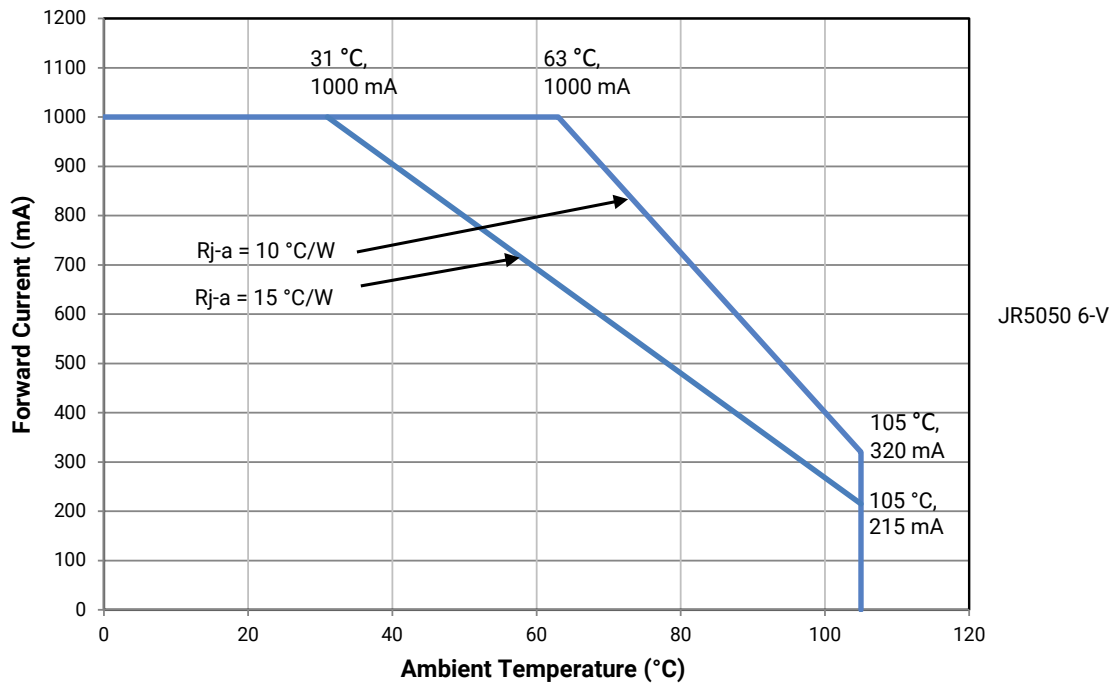

FLUX CHARACTERISTICS, ORDER CODES AND BINS - JR5050 6-V ($I_F = 400 \text{ mA}$, $T_j = 25 \text{ °C}$)

The following table provides order codes for J Series 5050 LEDs. For a complete description of the order code nomenclature, please see the Order Code and Bin Code Formats section (page 3). For definitions of the chromaticity kits, please see the Performance Groups - Chromaticity section (page 27).

Nominal CCT	Minimum CRI [†]	Minimum Flux (lm) @ 25 °C	Typical Flux (lm) @ 25 °C	Typical Flux (lm) @ 85 °C*	Order Code
6500 K	70	350	410	372	JR5050AWT-00-0000-000B0BQ465E
	80	350	390	354	JR5050AWT-00-0000-000B0HQ465E
	90	300	330	299	JR5050AWT-00-0000-000B0UQ265E
5700 K	70	350	420	381	JR5050AWT-00-0000-000B0BQ457E
	80	350	400	363	JR5050AWT-00-0000-000B0HQ457E
	90	300	340	308	JR5050AWT-00-0000-000B0UQ257E
5000 K	70	350	420	381	JR5050AWT-00-0000-000B0BQ450E
	80	350	400	363	JR5050AWT-00-0000-000B0HQ450E
	90	300	340	308	JR5050AWT-00-0000-000B0UQ250E
4500 K	70	350	420	381	JR5050AWT-00-0000-000B0BQ445E
	80	350	400	363	JR5050AWT-00-0000-000B0HQ445E
	90	300	340	308	JR5050AWT-00-0000-000B0UQ245E
4000 K	70	350	420	381	JR5050AWT-00-0000-000B0BQ440E
	80	350	400	363	JR5050AWT-00-0000-000B0HQ440E
	90	300	340	308	JR5050AWT-00-0000-000B0UQ240E
3500 K	70	350	410	372	JR5050AWT-00-0000-000B0BQ435E
	80	350	390	354	JR5050AWT-00-0000-000B0HQ435E
	90	300	330	299	JR5050AWT-00-0000-000B0UQ235E
3000 K	70	350	400	363	JR5050AWT-00-0000-000B0BQ430E
	80	350	380	345	JR5050AWT-00-0000-000B0HQ430E
	90	250	320	290	JR5050AWT-00-0000-000B0UP430E
2700 K	70	350	385	349	JR5050AWT-00-0000-000B0BQ427E
	80	300	365	331	JR5050AWT-00-0000-000B0HQ227E
	90	250	305	277	JR5050AWT-00-0000-000B0UP427E

Notes:

- Cree Venture maintains a tolerance of $\pm 7\%$ on flux and power measurements, ± 0.005 on chromaticity (CCx, CCy) measurements and ± 2 on CRI measurements. See the Measurements section (page 37).
- Cree Venture J Series 5050 LED order codes specify only a minimum flux bin and not a maximum. Cree Venture may ship reels in flux bins higher than the minimum specified by the order code without advance notice. Shipments will always adhere to the chromaticity restrictions specified by the order code.
- ◊ CRI R9 minimum is 0 for 80 CRI minimum LEDs and 50 for 90 CRI minimum LEDs, with a ± 3 tolerance.
- * Flux values @ 85 °C are calculated and for reference only.

RELATIVE LUMINOUS FLUX VS. CURRENT - JR5050 6-V

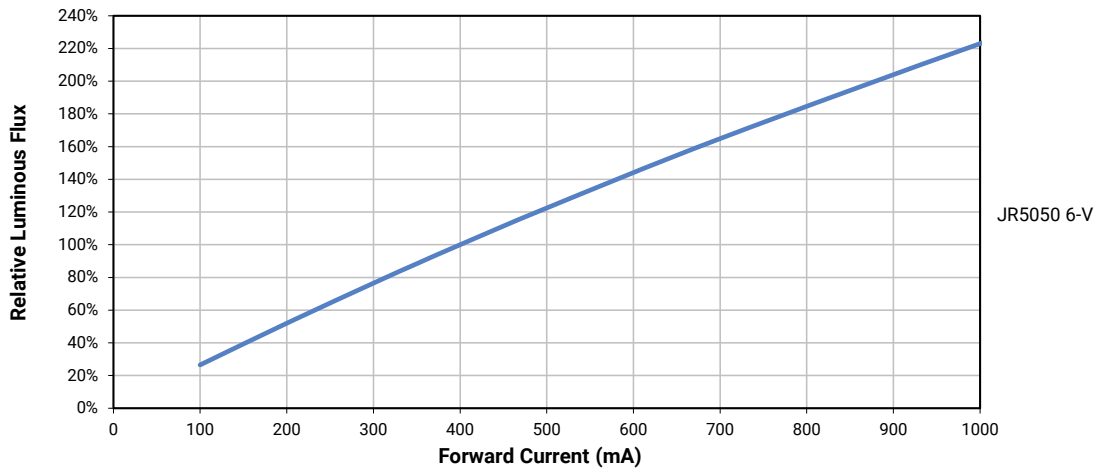

ELECTRICAL CHARACTERISTICS - JR5050 6-V

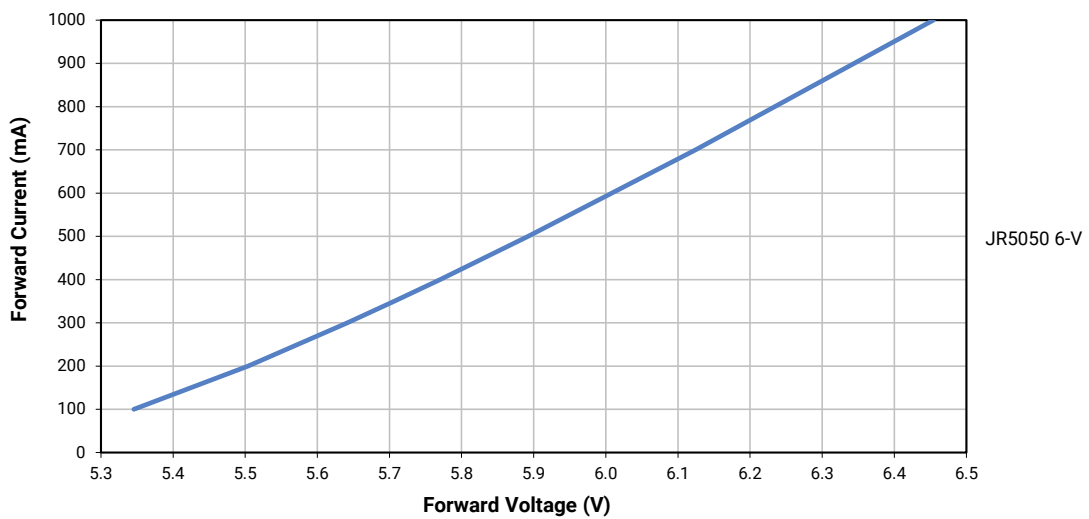

RELATIVE CHROMATICITY VS. CURRENT - JR5050 6-V

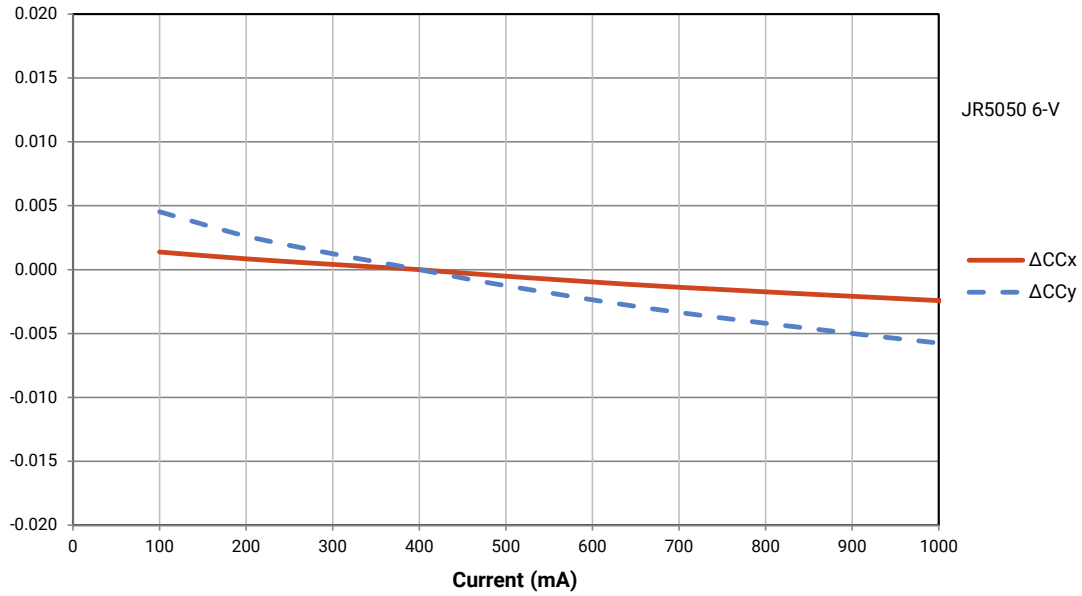

RELATIVE CHROMATICITY VS. TEMPERATURE - JR5050 6-V

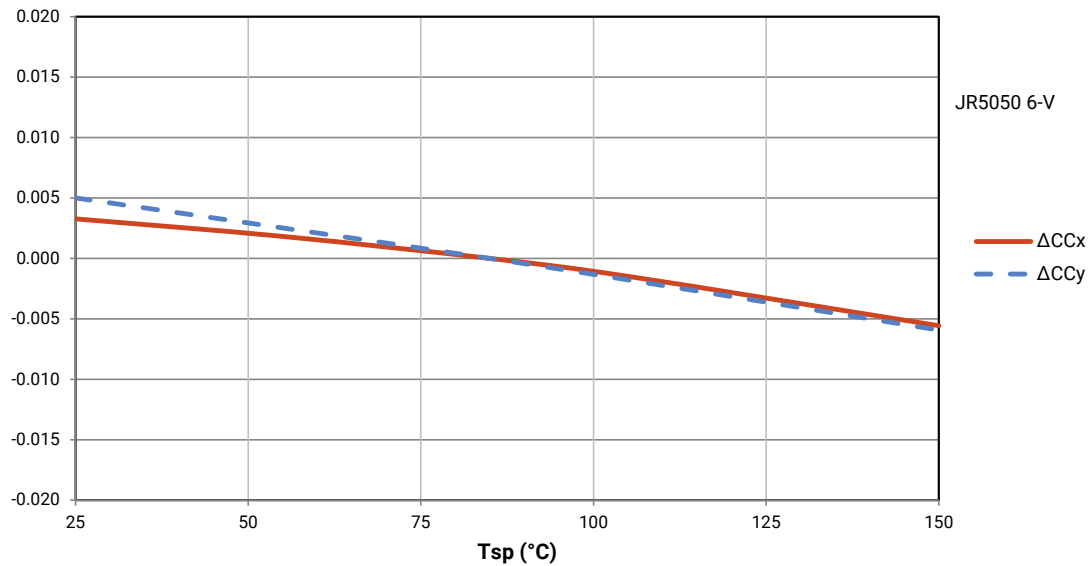

CHARACTERISTICS - JR5050 9-V

Characteristics	Unit	Minimum	Typical	Maximum
Thermal resistance, junction to solder point	°C/W		3	
Viewing angle (FWHM)	degrees		120	
Temperature coefficient of voltage	mV/°C		-2.7	
ESD withstand voltage (JEDEC JS-001-2012)	V		Class 2	
DC forward current	mA			660
Reverse voltage	V			5
Forward voltage (@ 260 mA, 25 °C)	V		8.6	10.5
LED junction temperature	°C			125
Operating temperature	°C	-40		105

OPERATING LIMITS - JR5050 9-V

The maximum forward current is determined by the thermal resistance between the LED junction and ambient.

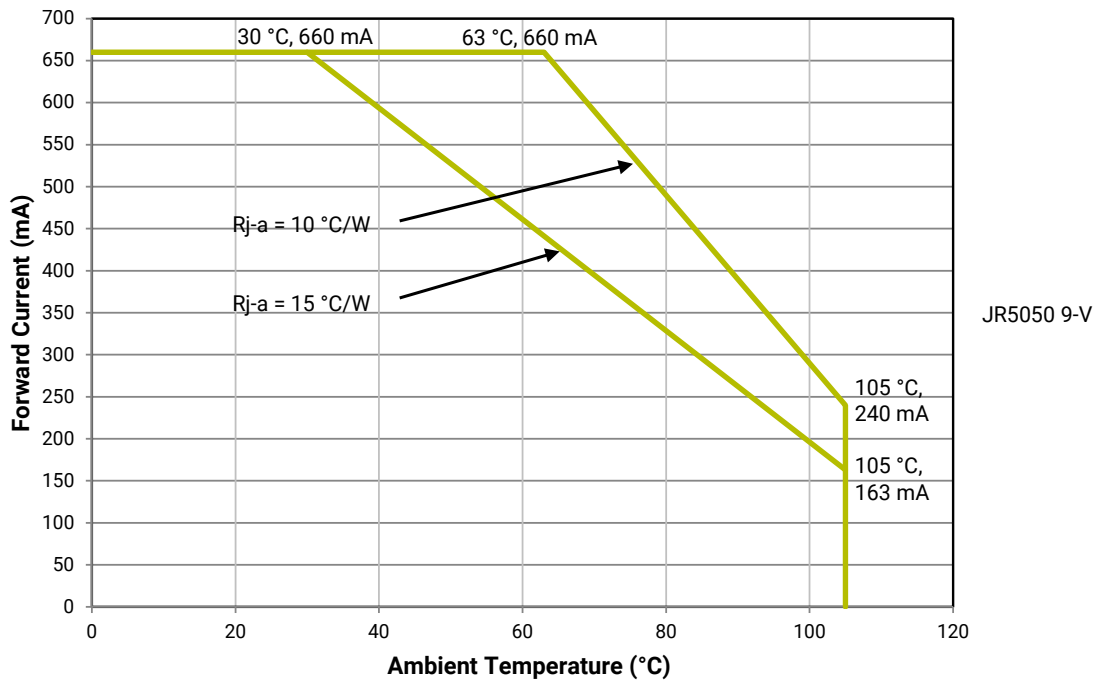

FLUX CHARACTERISTICS, ORDER CODES AND BINS - JR5050 9-V ($I_F = 260 \text{ mA}$, $T_j = 25 \text{ °C}$)

The following table provides order codes for J Series 5050 LEDs. For a complete description of the order code nomenclature, please see the Order Code and Bin Code Formats section (page 3). For definitions of the chromaticity kits, please see the Performance Groups - Chromaticity section (page 27).

Nominal CCT	Minimum CRI [†]	Minimum Flux (lm) @ 25 °C	Typical Flux (lm) @ 25 °C	Typical Flux (lm) @ 85 °C*	Order Code
6500 K	70	350	398	362	JR5050AWT-00-0000-000C0BQ465E
	80	300	378	344	JR5050AWT-00-0000-000C0HQ265E
	90	250	320	291	JR5050AWT-00-0000-000C0UP465E
5700 K	70	350	407	370	JR5050AWT-00-0000-000C0BQ457E
	80	300	388	353	JR5050AWT-00-0000-000C0HQ257E
	90	250	330	300	JR5050AWT-00-0000-000C0UP457E
5000 K	70	350	407	370	JR5050AWT-00-0000-000C0BQ450E
	80	300	388	353	JR5050AWT-00-0000-000C0HQ250E
	90	250	330	300	JR5050AWT-00-0000-000C0UP450E
4500 K	70	350	407	370	JR5050AWT-00-0000-000C0BQ445E
	80	300	388	353	JR5050AWT-00-0000-000C0HQ245E
	90	250	330	300	JR5050AWT-00-0000-000C0UP445E
4000 K	70	350	407	370	JR5050AWT-00-0000-000C0BQ440E
	80	300	388	353	JR5050AWT-00-0000-000C0HQ240E
	90	250	330	300	JR5050AWT-00-0000-000C0UP440E
3500 K	70	350	398	362	JR5050AWT-00-0000-000C0BQ435E
	80	300	378	344	JR5050AWT-00-0000-000C0HQ235E
	90	250	320	291	JR5050AWT-00-0000-000C0UP435E
3000 K	70	300	388	353	JR5050AWT-00-0000-000C0BQ230E
	80	300	369	335	JR5050AWT-00-0000-000C0HQ230E
	90	250	310	282	JR5050AWT-00-0000-000C0UP430E
2700 K	70	300	373	339	JR5050AWT-00-0000-000C0BQ227E
	80	300	354	322	JR5050AWT-00-0000-000C0HQ227E
	90	250	296	269	JR5050AWT-00-0000-000C0UP427E

Notes:

- Cree Venture maintains a tolerance of $\pm 7\%$ on flux and power measurements, ± 0.005 on chromaticity (CCx, CCy) measurements and ± 2 on CRI measurements. See the Measurements section (page 37).
- Cree Venture J Series 5050 LED order codes specify only a minimum flux bin and not a maximum. Cree Venture may ship reels in flux bins higher than the minimum specified by the order code without advance notice. Shipments will always adhere to the chromaticity restrictions specified by the order code.
- ◊ CRI R9 minimum is 0 for 80 CRI minimum LEDs and 50 for 90 CRI minimum LEDs, with a ± 3 tolerance.
- * Flux values @ 85 °C are calculated and for reference only.

RELATIVE LUMINOUS FLUX VS. CURRENT - JR5050 9-V

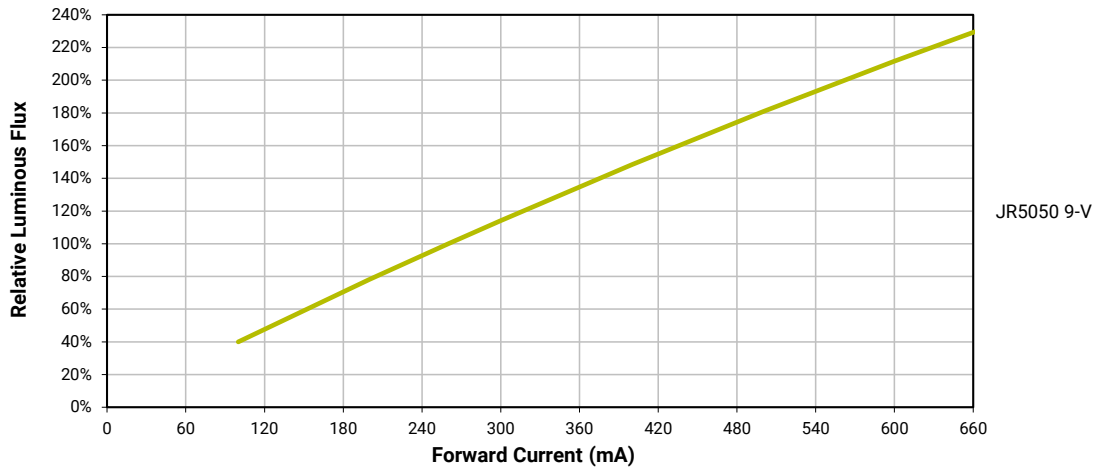

ELECTRICAL CHARACTERISTICS - JR5050 9-V

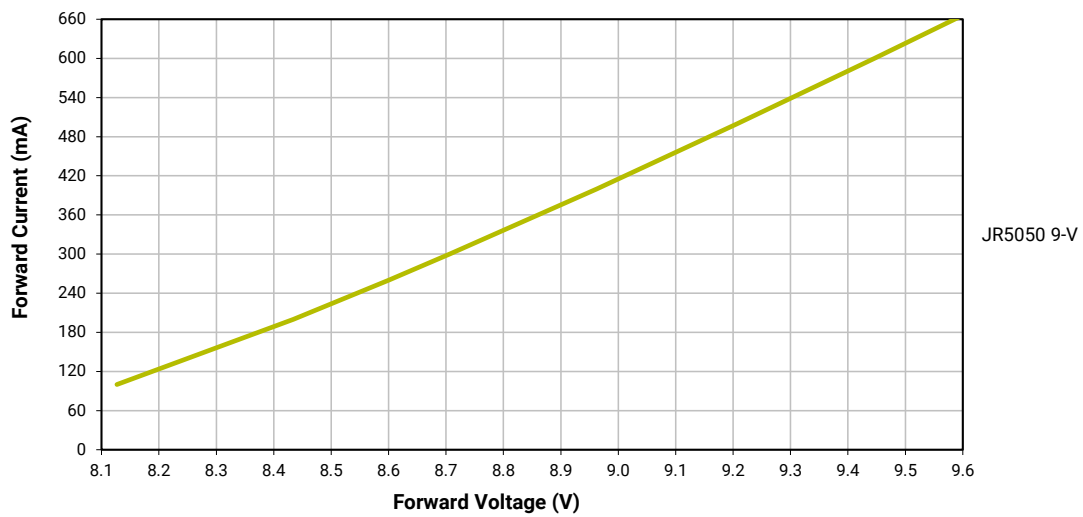

RELATIVE CHROMATICITY VS. CURRENT - JR5050 9-V

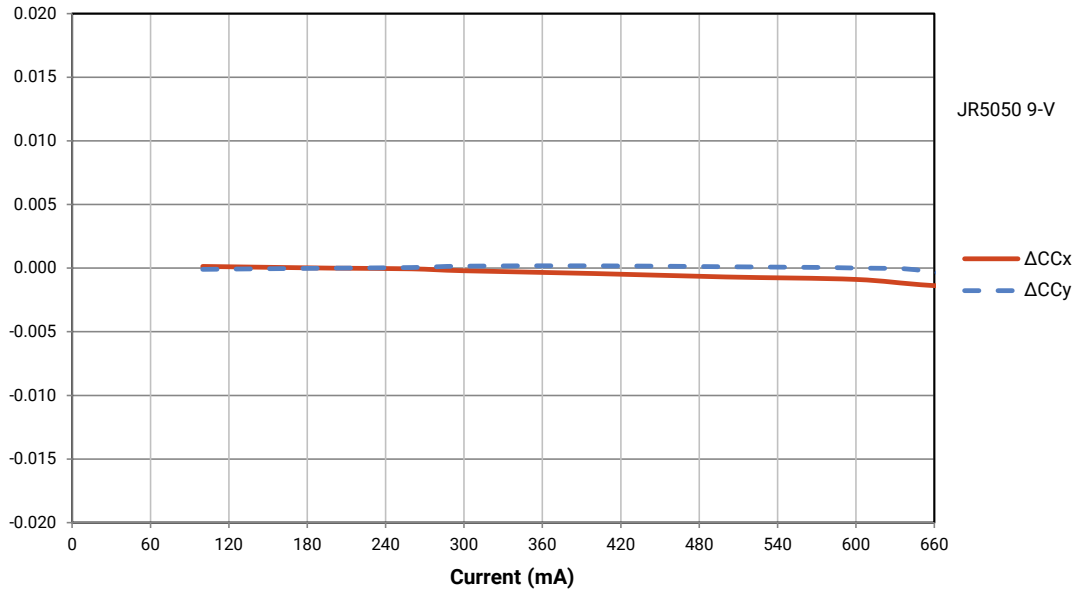

RELATIVE CHROMATICITY VS. TEMPERATURE - JR5050 9-V

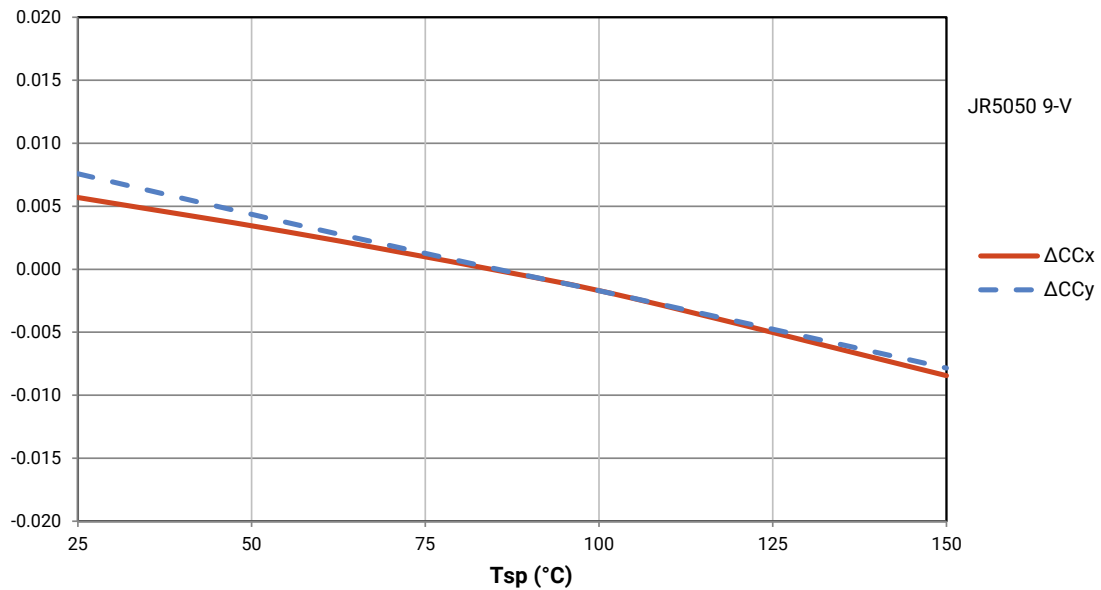

CHARACTERISTICS - JR5050 12-V

Characteristics	Unit	Minimum	Typical	Maximum
Thermal resistance, junction to solder point	°C/W		3	
Viewing angle (FWHM)	degrees		120	
Temperature coefficient of voltage	mV/°C		-3.3	
ESD withstand voltage (JEDEC JS-001-2012)	V		Class 2	
DC forward current	mA			480
Reverse voltage	V			5
Forward voltage (@ 200 mA, 25 °C)	V		12.3	13
LED junction temperature	°C			125
Operating temperature	°C	-40		105

OPERATING LIMITS - JR5050 12-V

The maximum forward current is determined by the thermal resistance between the LED junction and ambient.

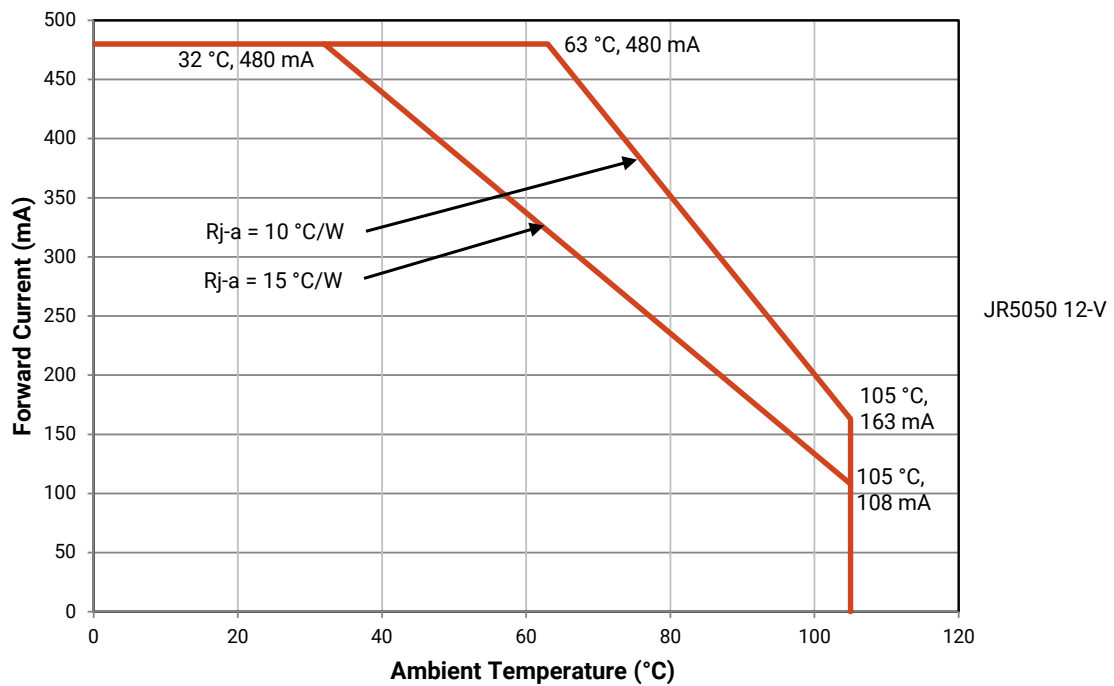

FLUX CHARACTERISTICS, ORDER CODES AND BINS - JR5050 12-V ($I_F = 200 \text{ mA}$, $T_j = 25 \text{ °C}$)

The following table provides order codes for J Series 5050 LEDs. For a complete description of the order code nomenclature, please see the Order Code and Bin Code Formats section (page 3). For definitions of the chromaticity kits, please see the Performance Groups - Chromaticity section (page 27).

Nominal CCT	Minimum CRI [†]	Minimum Flux (lm) @ 25 °C	Typical Flux (lm) @ 25 °C	Typical Flux (lm) @ 85 °C*	Order Code
6500 K	70	350	420	383	JR5050AWT-00-0000-000D0BQ465E
	80	350	400	365	JR5050AWT-00-0000-000D0HQ465E
	90	300	340	310	JR5050AWT-00-0000-000D0UQ265E
5700 K	70	350	420	383	JR5050AWT-00-0000-000D0BQ457E
	80	350	400	365	JR5050AWT-00-0000-000D0HQ457E
	90	300	340	310	JR5050AWT-00-0000-000D0UQ257E
5000 K	70	350	420	383	JR5050AWT-00-0000-000D0BQ450E
	80	350	400	365	JR5050AWT-00-0000-000D0HQ450E
	90	300	340	310	JR5050AWT-00-0000-000D0UQ250E
4500 K	70	350	420	383	JR5050AWT-00-0000-000D0BQ445E
	80	350	400	365	JR5050AWT-00-0000-000D0HQ445E
	90	300	340	310	JR5050AWT-00-0000-000D0UQ245E
4000 K	70	350	420	383	JR5050AWT-00-0000-000D0BQ440E
	80	350	400	365	JR5050AWT-00-0000-000D0HQ440E
	90	300	340	310	JR5050AWT-00-0000-000D0UQ240E
3500 K	70	350	410	374	JR5050AWT-00-0000-000D0BQ435E
	80	350	390	356	JR5050AWT-00-0000-000D0HQ435E
	90	250	330	301	JR5050AWT-00-0000-000D0UP435E
3000 K	70	300	400	365	JR5050AWT-00-0000-000D0BQ230E
	80	300	380	347	JR5050AWT-00-0000-000D0HQ230E
	90	250	320	292	JR5050AWT-00-0000-000D0UP430E
2700 K	70	300	385	351	JR5050AWT-00-0000-000D0BQ227E
	80	300	365	333	JR5050AWT-00-0000-000D0HQ227E
	90	250	310	283	JR5050AWT-00-0000-000D0UP427E

Notes:

- Cree Venture maintains a tolerance of $\pm 7\%$ on flux and power measurements, ± 0.005 on chromaticity (CCx, CCy) measurements and ± 2 on CRI measurements. See the Measurements section (page 37).
- Cree Venture J Series 5050 LED order codes specify only a minimum flux bin and not a maximum. Cree Venture may ship reels in flux bins higher than the minimum specified by the order code without advance notice. Shipments will always adhere to the chromaticity restrictions specified by the order code.
- ◊ CRI R9 minimum is 0 for 80 CRI minimum LEDs and 50 for 90 CRI minimum LEDs, with a ± 3 tolerance.
- * Flux values @ 85 °C are calculated and for reference only.

RELATIVE LUMINOUS FLUX VS. CURRENT - JR5050 12-V

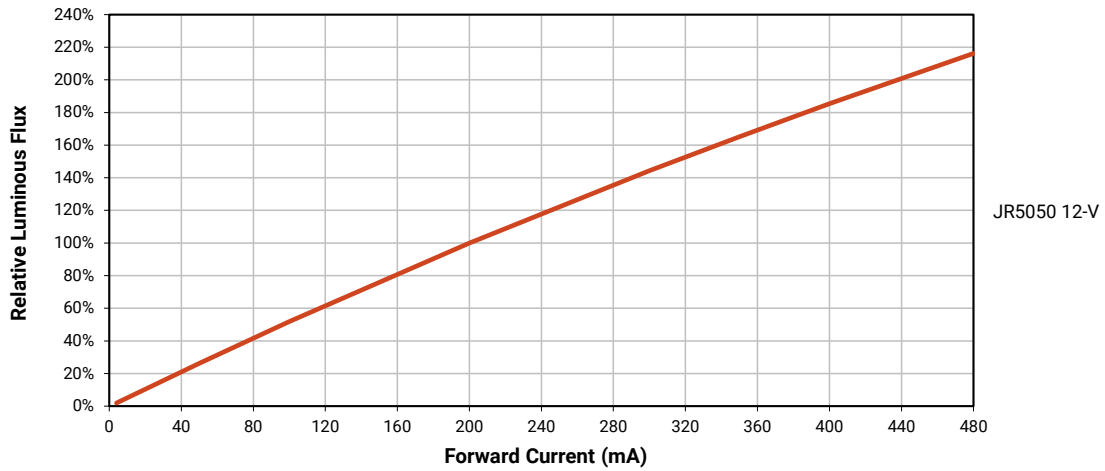

ELECTRICAL CHARACTERISTICS - JR5050 12-V

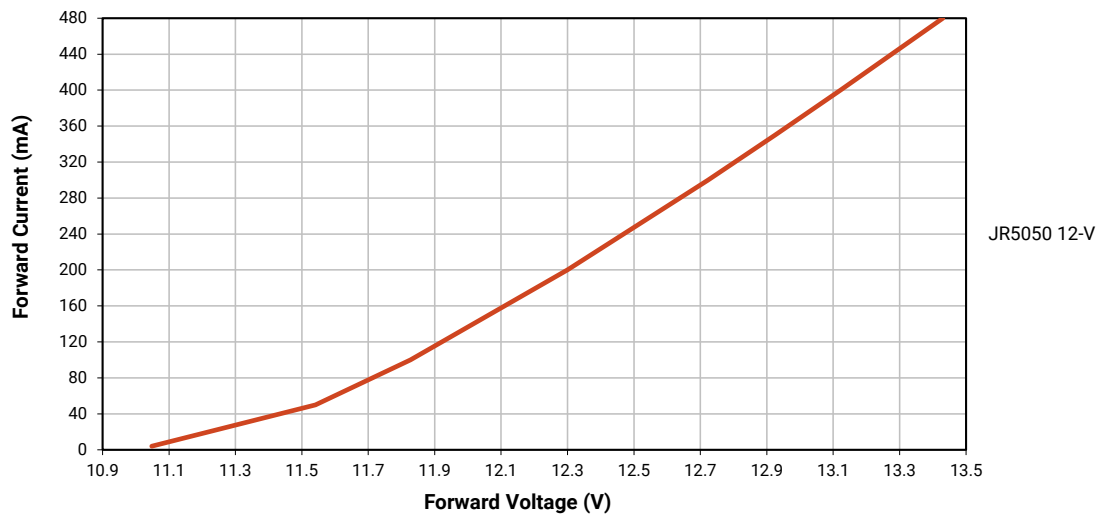

RELATIVE CHROMATICITY VS. CURRENT - JR5050 12-V

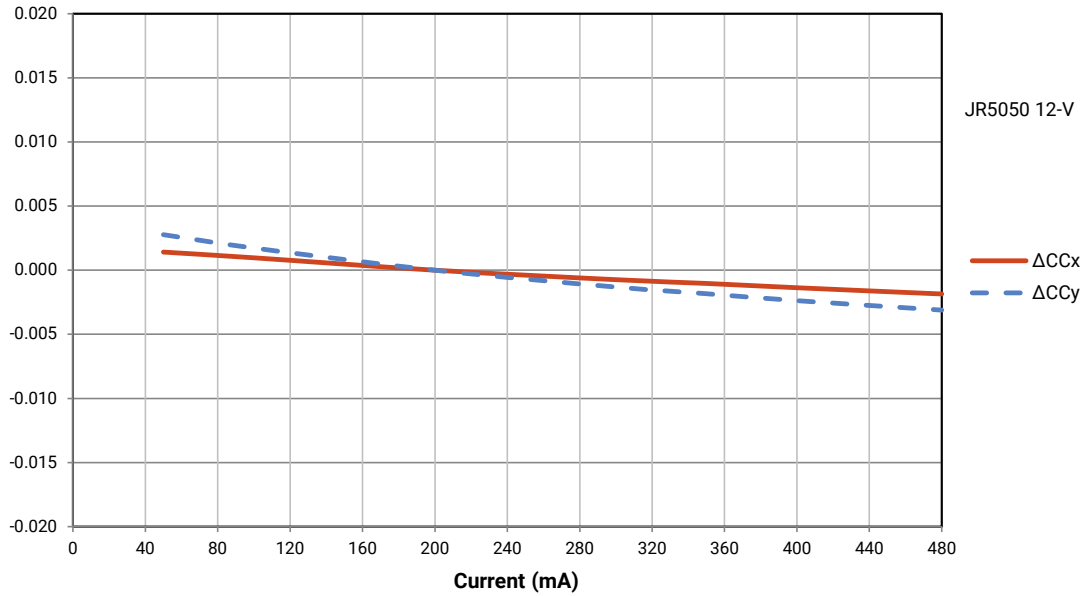

RELATIVE CHROMATICITY VS. TEMPERATURE - JR5050 12-V

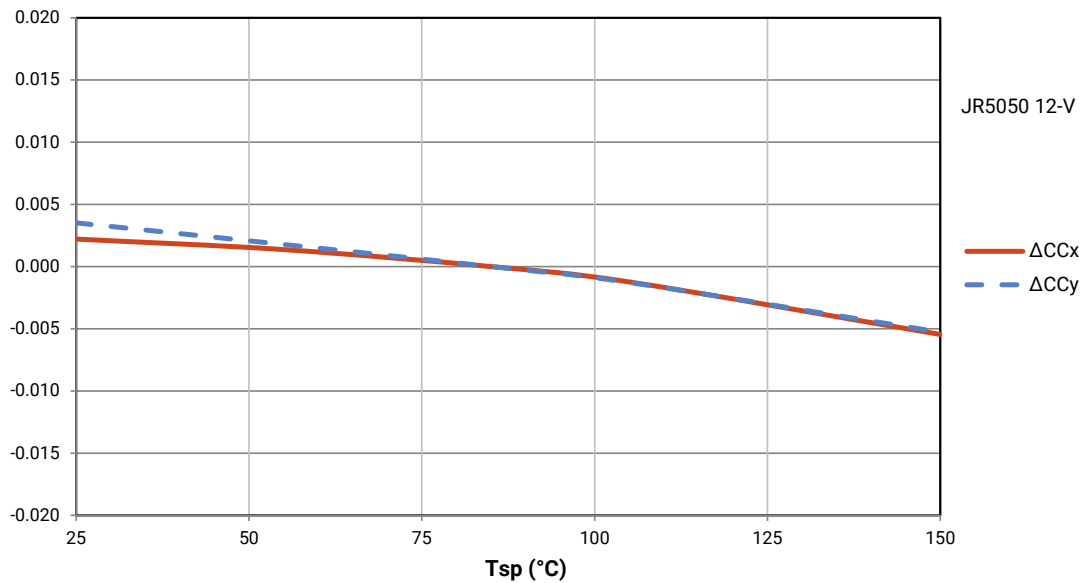

CHARACTERISTICS - JR5050 24-V

Characteristics	Unit	Minimum	Typical	Maximum
Thermal resistance, junction to solder point	°C/W		3	
Viewing angle (FWHM)	degrees		120	
Temperature coefficient of voltage	mV/°C		-6.7	
ESD withstand voltage (JEDEC JS-001-2012)	V		Class 2	
DC forward current	mA			240
Reverse voltage	V			5
Forward voltage (@ 100 mA, 25 °C)	V		24.5	26.5
LED junction temperature	°C			125
Operating temperature	°C	-40		105

OPERATING LIMITS - JR5050 24-V

The maximum forward current is determined by the thermal resistance between the LED junction and ambient.

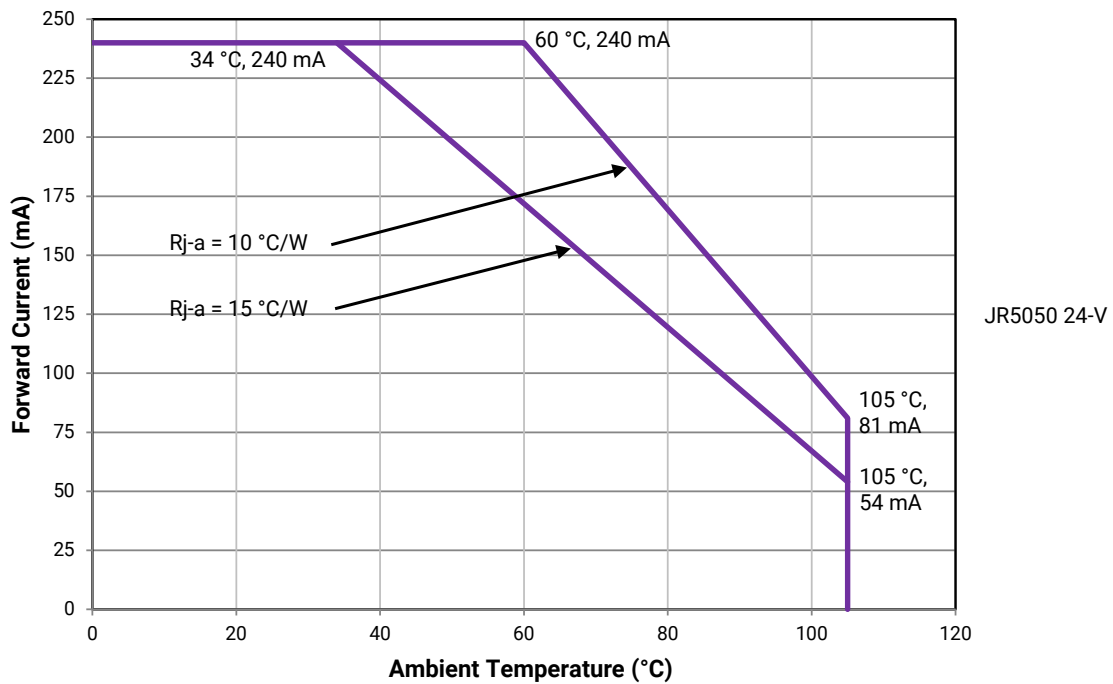

FLUX CHARACTERISTICS, ORDER CODES AND BINS - JR5050 24-V ($I_F = 100 \text{ mA}$, $T_j = 25 \text{ °C}$)

The following table provides order codes for J Series 5050 LEDs. For a complete description of the order code nomenclature, please see the Order Code and Bin Code Formats section (page 3). For definitions of the chromaticity kits, please see the Performance Groups - Chromaticity section (page 27).

Nominal CCT	Minimum CRI [†]	Minimum Flux (lm) @ 25 °C	Typical Flux (lm) @ 25 °C	Typical Flux (lm) @ 85 °C*	Order Code
6500 K	70	350	420	383	JR5050AWT-00-0000-000H0BQ465E
	80	350	400	365	JR5050AWT-00-0000-000H0HQ465E
	90	300	340	310	JR5050AWT-00-0000-000H0UQ265E
5700 K	70	350	420	383	JR5050AWT-00-0000-000H0BQ457E
	80	350	400	365	JR5050AWT-00-0000-000H0HQ457E
	90	300	340	310	JR5050AWT-00-0000-000H0UQ257E
5000 K	70	350	420	383	JR5050AWT-00-0000-000H0BQ450E
	80	350	400	365	JR5050AWT-00-0000-000H0HQ450E
	90	300	340	310	JR5050AWT-00-0000-000H0UQ250E
4500 K	70	350	420	383	JR5050AWT-00-0000-000H0BQ445E
	80	350	400	365	JR5050AWT-00-0000-000H0HQ445E
	90	300	340	310	JR5050AWT-00-0000-000H0UQ245E
4000 K	70	350	420	383	JR5050AWT-00-0000-000H0BQ440E
	80	350	400	365	JR5050AWT-00-0000-000H0HQ440E
	90	300	340	310	JR5050AWT-00-0000-000H0UQ240E
3500 K	70	350	410	374	JR5050AWT-00-0000-000H0BQ435E
	80	350	390	356	JR5050AWT-00-0000-000H0HQ435E
	90	250	330	301	JR5050AWT-00-0000-000H0UP435E
3000 K	70	300	400	365	JR5050AWT-00-0000-000H0BQ230E
	80	300	380	347	JR5050AWT-00-0000-000H0HQ230E
	90	250	320	292	JR5050AWT-00-0000-000H0UP430E
2700 K	70	300	385	351	JR5050AWT-00-0000-000H0BQ227E
	80	300	365	333	JR5050AWT-00-0000-000H0HQ227E
	90	250	310	283	JR5050AWT-00-0000-000H0UP427E

Notes:

- Cree Venture maintains a tolerance of $\pm 7\%$ on flux and power measurements, ± 0.005 on chromaticity (CCx, CCy) measurements and ± 2 on CRI measurements. See the Measurements section (page 37).
- Cree Venture J Series 5050 LED order codes specify only a minimum flux bin and not a maximum. Cree Venture may ship reels in flux bins higher than the minimum specified by the order code without advance notice. Shipments will always adhere to the chromaticity restrictions specified by the order code.
- ◊ CRI R9 minimum is 0 for 80 CRI minimum LEDs and 50 for 90 CRI minimum LEDs, with a ± 3 tolerance.
- * Flux values @ 85 °C are calculated and for reference only.

RELATIVE LUMINOUS FLUX VS. CURRENT - JR5050 24-V

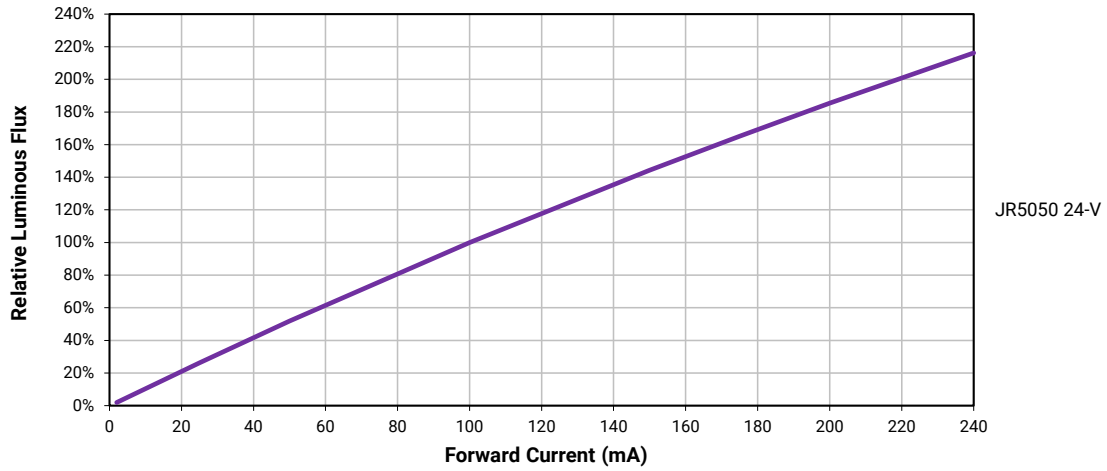

ELECTRICAL CHARACTERISTICS - JR5050 24-V

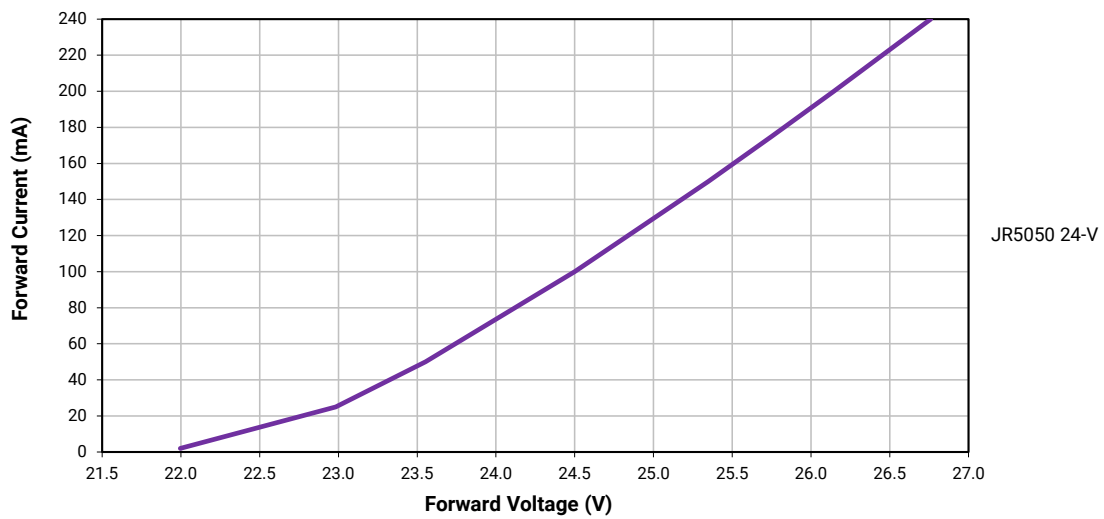

RELATIVE CHROMATICITY VS. CURRENT - JR5050 24-V

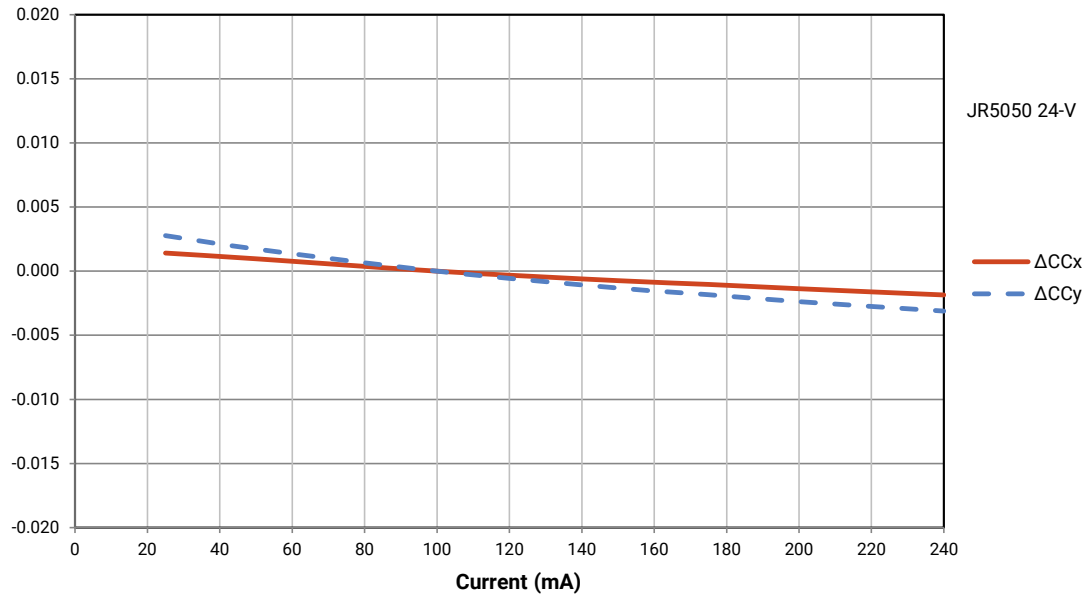

RELATIVE CHROMATICITY VS. TEMPERATURE - JR5050 24-V

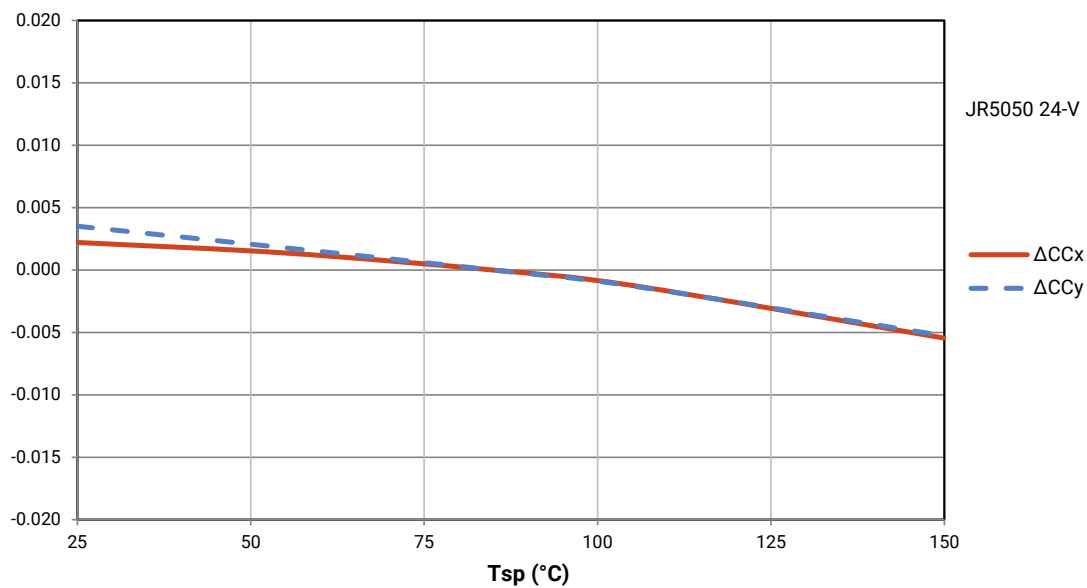

CHARACTERISTICS - JR5050 36-V

Characteristics	Unit	Minimum	Typical	Maximum
Thermal resistance, junction to solder point	°C/W		3	
Viewing angle (FWHM)	degrees		120	
Temperature coefficient of voltage	mV/°C		-10	
ESD withstand voltage (JEDEC JS-001-2012)	V		Class 2	
DC forward current	mA			165
Reverse voltage	V			5
Forward voltage (@ 65 mA, 25 °C)	V		34.5	37
LED junction temperature	°C			125
Operating temperature	°C	-40		105

OPERATING LIMITS - JR5050 36-V

The maximum forward current is determined by the thermal resistance between the LED junction and ambient.

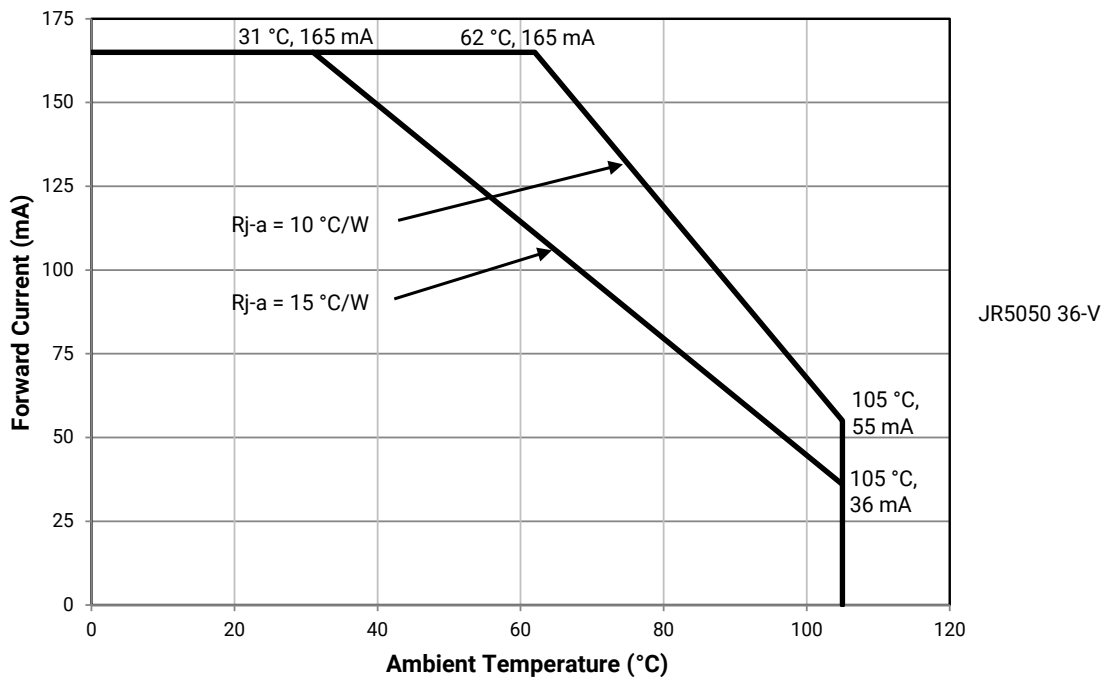

FLUX CHARACTERISTICS, ORDER CODES AND BINS - JR5050 36-V ($I_F = 65 \text{ mA}$, $T_j = 25 \text{ °C}$)

The following table provides order codes for J Series 5050 LEDs. For a complete description of the order code nomenclature, please see the Order Code and Bin Code Formats section (page 3). For definitions of the chromaticity kits, please see the Performance Groups - Chromaticity section (page 27).

Nominal CCT	Minimum CRI [†]	Minimum Flux (lm) @ 25 °C	Typical Flux (lm) @ 25 °C	Typical Flux (lm) @ 85 °C*	Order Code
6500 K	70	350	398	362	JR5050AWT-00-0000-000N0BQ265E
	80	300	378	344	JR5050AWT-00-0000-000N0HQ265E
	90	250	320	291	JR5050AWT-00-0000-000N0UP465E
5700 K	70	350	407	370	JR5050AWT-00-0000-000N0BQ257E
	80	300	388	353	JR5050AWT-00-0000-000N0HQ257E
	90	250	330	300	JR5050AWT-00-0000-000N0UP457E
5000 K	70	350	407	370	JR5050AWT-00-0000-000N0BQ250E
	80	300	388	353	JR5050AWT-00-0000-000N0HQ250E
	90	250	330	300	JR5050AWT-00-0000-000N0UP450E
4500 K	70	350	407	370	JR5050AWT-00-0000-000N0BQ245E
	80	300	388	353	JR5050AWT-00-0000-000N0HQ245E
	90	250	330	300	JR5050AWT-00-0000-000N0UP445E
4000 K	70	350	407	370	JR5050AWT-00-0000-000N0BQ240E
	80	300	388	353	JR5050AWT-00-0000-000N0HQ240E
	90	250	330	300	JR5050AWT-00-0000-000N0UP440E
3500 K	70	350	398	362	JR5050AWT-00-0000-000N0BQ235E
	80	300	378	344	JR5050AWT-00-0000-000N0HQ235E
	90	250	320	291	JR5050AWT-00-0000-000N0UP435E
3000 K	70	300	388	353	JR5050AWT-00-0000-000N0BQ230E
	80	300	369	335	JR5050AWT-00-0000-000N0HP430E
	90	250	310	282	JR5050AWT-00-0000-000N0UP230E
2700 K	70	300	373	339	JR5050AWT-00-0000-000N0BP427E
	80	300	354	322	JR5050AWT-00-0000-000N0HP427E
	90	250	296	269	JR5050AWT-00-0000-000N0UP227E

Notes:

- Cree Venture maintains a tolerance of $\pm 7\%$ on flux and power measurements, ± 0.005 on chromaticity (CCx, CCy) measurements and ± 2 on CRI measurements. See the Measurements section (page 37).
- Cree Venture J Series 5050 LED order codes specify only a minimum flux bin and not a maximum. Cree Venture may ship reels in flux bins higher than the minimum specified by the order code without advance notice. Shipments will always adhere to the chromaticity restrictions specified by the order code.
- ◊ CRI R9 minimum is 0 for 80 CRI minimum LEDs and 50 for 90 CRI minimum LEDs, with a ± 3 tolerance.
- * Flux values @ 85 °C are calculated and for reference only.

RELATIVE LUMINOUS FLUX VS. CURRENT - JR5050 36-V

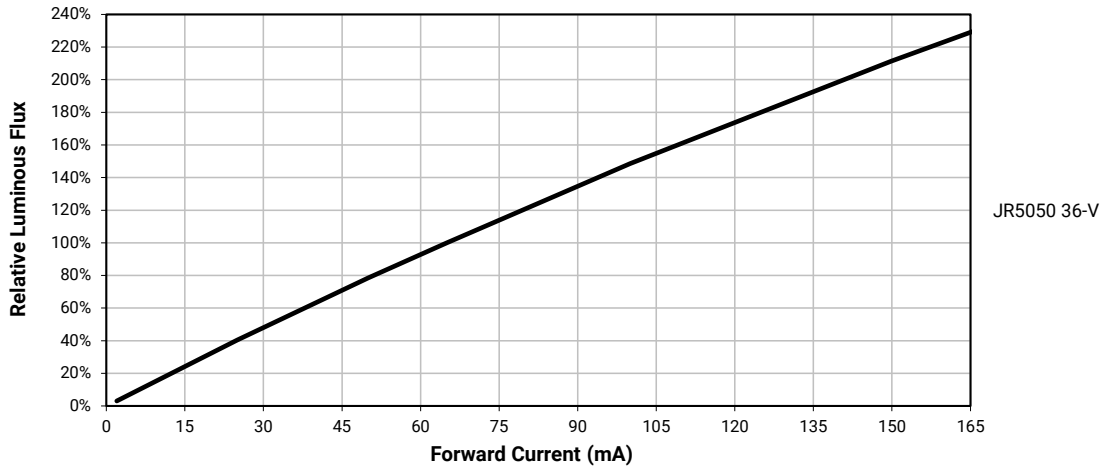

ELECTRICAL CHARACTERISTICS - JR5050 36-V

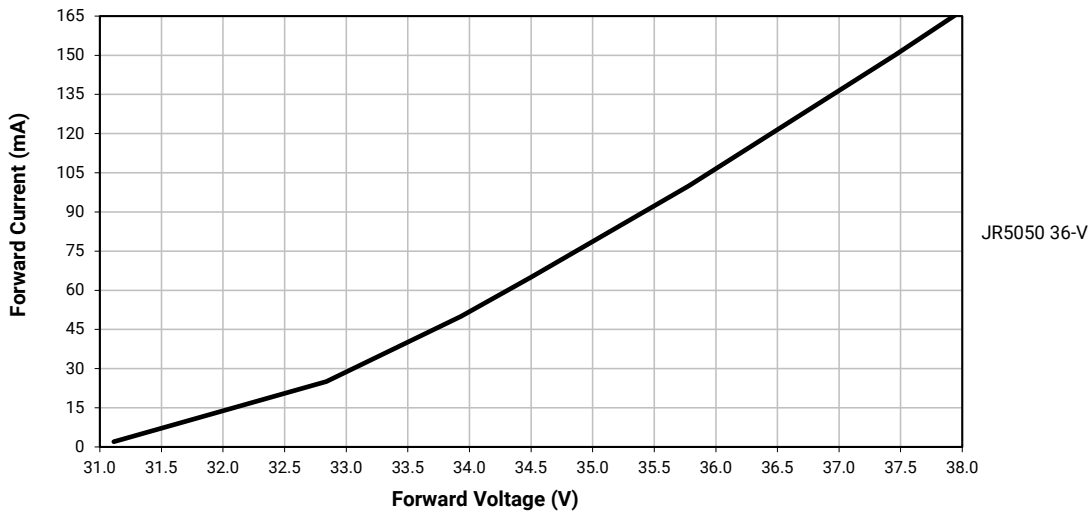

RELATIVE CHROMATICITY VS. CURRENT - JR5050 36-V

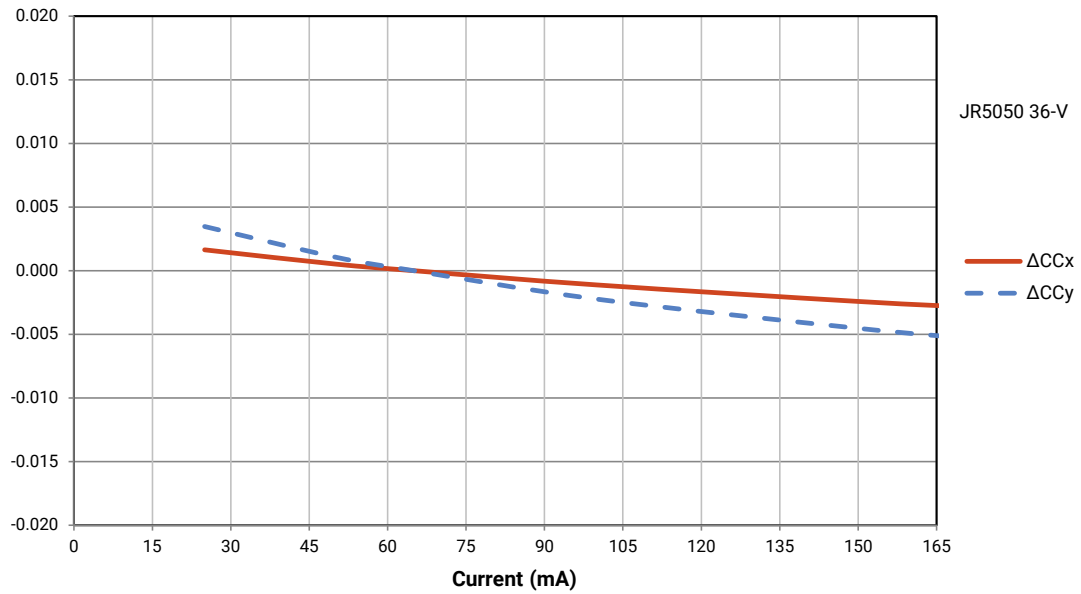

RELATIVE CHROMATICITY VS. TEMPERATURE - JR5050 36-V

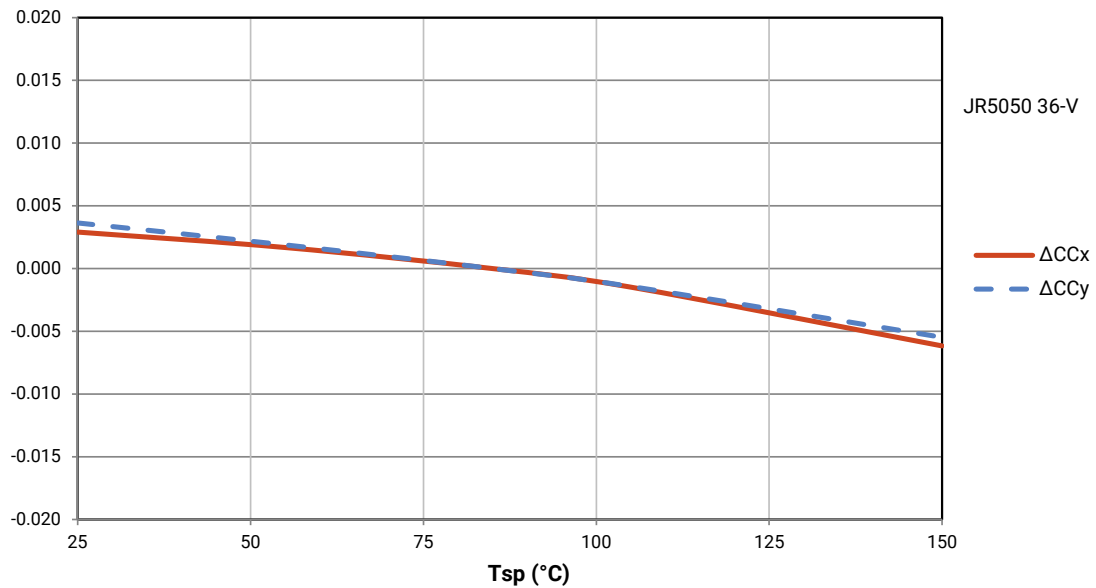

RELATIVE SPECTRAL POWER DISTRIBUTION

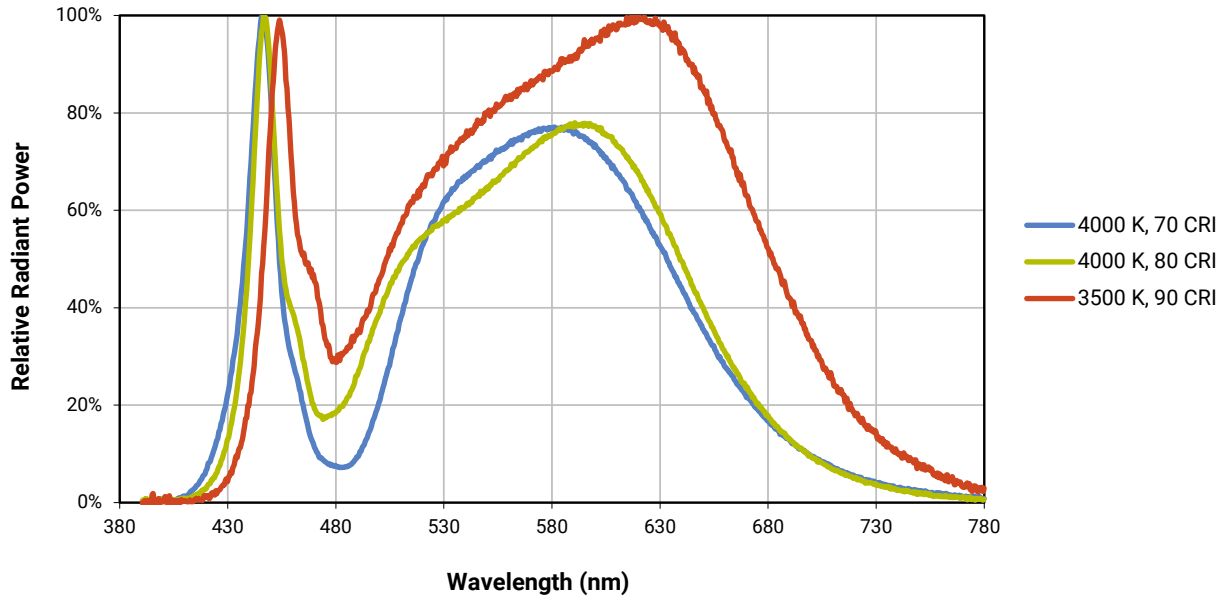

RELATIVE LUMINOUS FLUX VS. JUNCTION TEMPERATURE

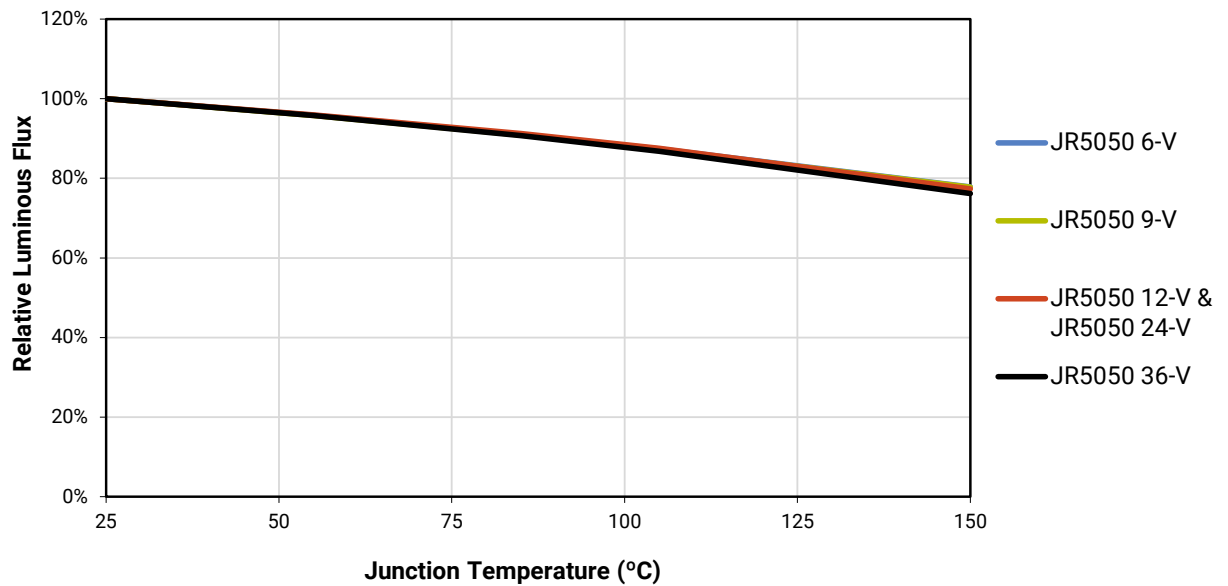

TYPICAL SPATIAL DISTRIBUTION

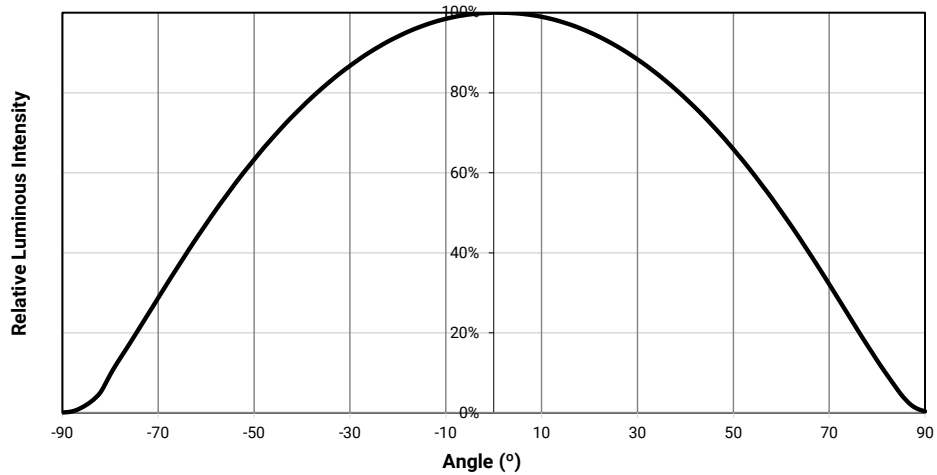

PERFORMANCE GROUPS - LUMINOUS FLUX (T_j = 25 °C)

J Series JR5050 LEDs are tested for luminous flux at the following current levels.

JR5050 LED	Tested For Luminous Flux At
6 V	400 mA
9 V	260 mA
12 V	200 mA
24 V	100 mA
36 V	65 mA

Once tested, J Series JR5050 LEDs are placed into one of the following luminous-flux groups.

Group Code	Minimum Luminous Flux (lm)	Maximum Luminous Flux (lm)
P2	200	250
P4	250	300
Q2	300	350
Q4	350	400
R2	400	450
R4	450	500

PERFORMANCE GROUPS - FORWARD VOLTAGE ($T_j = 25\text{ }^\circ\text{C}$)

J Series 5050 LEDs are tested for forward voltage and placed into one of the following voltage bins.

The following voltage bins are indicated in the Forward Voltage Bin field in the bin code for JR5050 6-V LEDs.

Voltage Bin	Minimum Forward Voltage (V)	Maximum Forward Voltage (V)
BN	5.6	5.8
BP	5.8	6
BQ	6	6.2

The following voltage bins are indicated in the Forward Voltage Bin field in the bin code for JR5050 9-V LEDs.

Voltage Bin	Minimum Forward Voltage (V)	Maximum Forward Voltage (V)
CT	8.0	8.5
CU	8.5	9.0
CV	9.0	9.5
CW	9.5	10.0
CY	10.0	10.5

The following voltage bins are indicated in the Forward Voltage Bin field in the bin code for JR5050 12-V LEDs.

Voltage Bin	Minimum Forward Voltage (V)	Maximum Forward Voltage (V)
DE	11.2	11.8
DF	11.8	12.4
DG	12.4	13.0
DH	13.0	13.6

The following voltage bins are indicated in the Forward Voltage Bin field in the bin code for JR5050 24-V LEDs.

Voltage Bin	Minimum Forward Voltage (V)	Maximum Forward Voltage (V)
HD	22.5	23.5
HE	23.5	24.5
HF	24.5	25.5
HG	25.5	26.5

The following voltage bins are indicated in the Forward Voltage Bin field in the bin code for JR5050 36-V LEDs.

Voltage Bin	Minimum Forward Voltage (V)	Maximum Forward Voltage (V)
NF	33	34
NG	34	35
NH	35	36
NJ	36	37

PERFORMANCE GROUPS - CHROMATICITY

J Series 5050 LEDs are tested for chromaticity and placed into one of the regions defined by the following bounding coordinates.

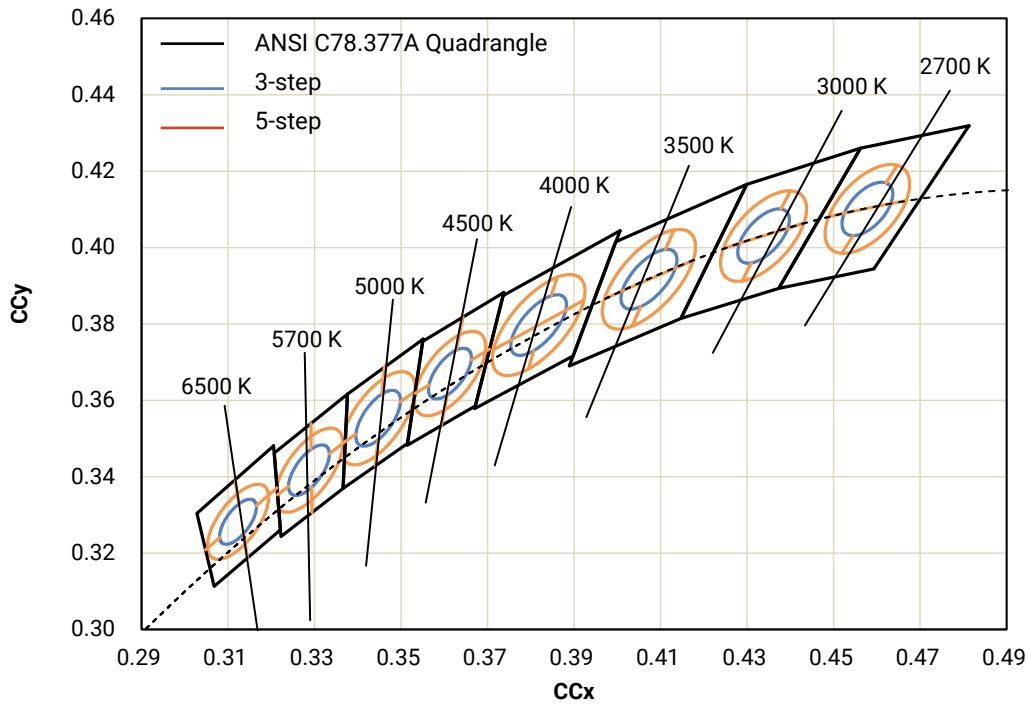

PERFORMANCE GROUPS - CHROMATICITY - CONTINUED

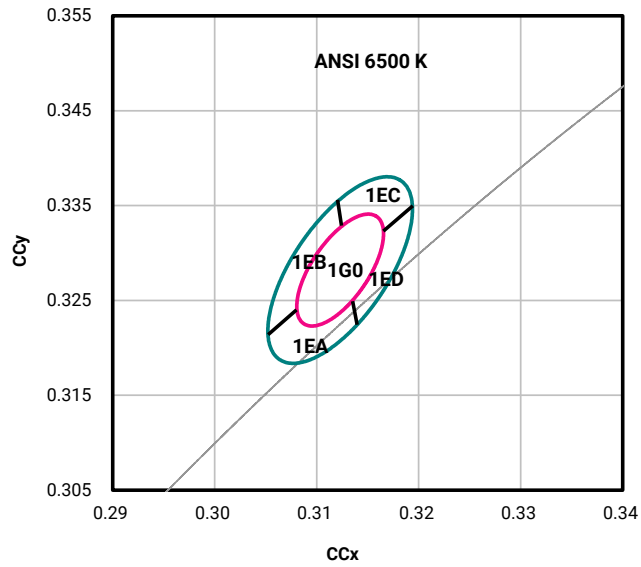

CCT	MacAdam Ellipse	Included Bins	Center Point		Major Axis	Minor Axis	Rotation Angle (°)
			x	y	a	b	
6500 K	3-step	1G0	0.3123	0.3282	0.00669	0.00285	58.57
	5-step	1G0, 1EA, 1EB, 1EC, 1ED	0.3123	0.3282	0.01115	0.00475	58.57

PERFORMANCE GROUPS - CHROMATICITY - CONTINUED

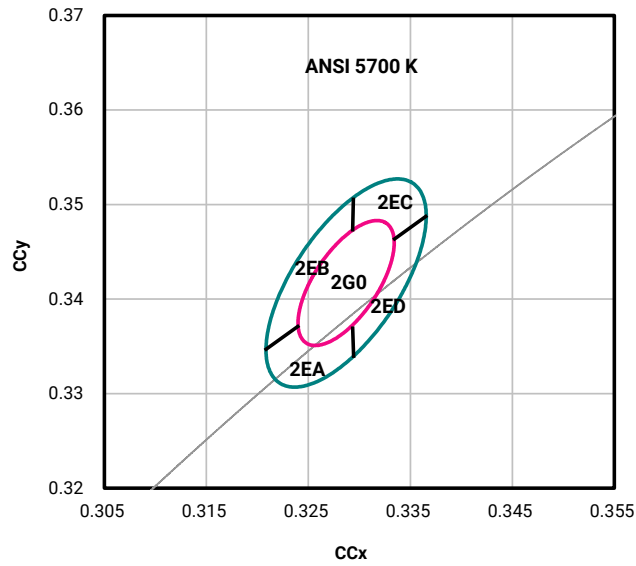

CCT	MacAdam Ellipse	Included Bins	Center Point		Major Axis	Minor Axis	Rotation Angle (°)
			x	y	a	b	
5700 K	3-step	2G0	0.3287	0.3417	0.00746	0.00320	59.09
	5-step	2G0, 2EA, 2EB, 2EC, 2ED	0.3287	0.3417	0.01243	0.00533	59.09

PERFORMANCE GROUPS - CHROMATICITY - CONTINUED

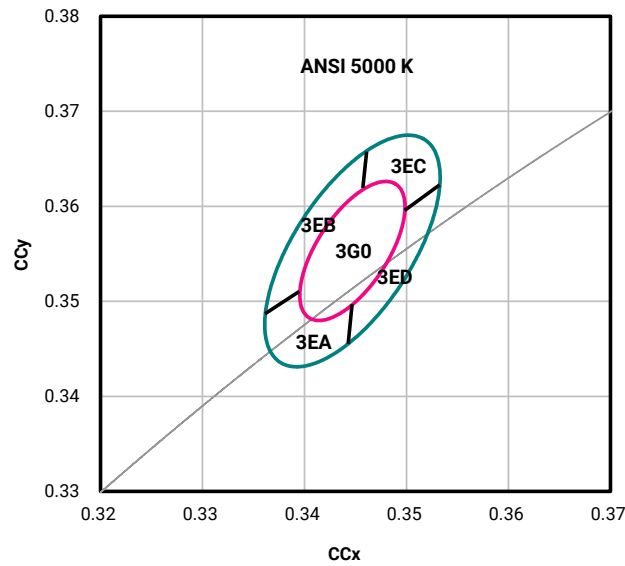

CCT	MacAdam Ellipse	Included Bins	Center Point		Major Axis	Minor Axis	Rotation Angle (°)
			x	y	a	b	
5000 K	3-step	3G0	0.3447	0.3553	0.00822	0.00354	59.62
	5-step	3G0, 3EA, 3EB, 3EC, 3ED	0.3447	0.3553	0.01370	0.00590	59.62

PERFORMANCE GROUPS - CHROMATICITY - CONTINUED

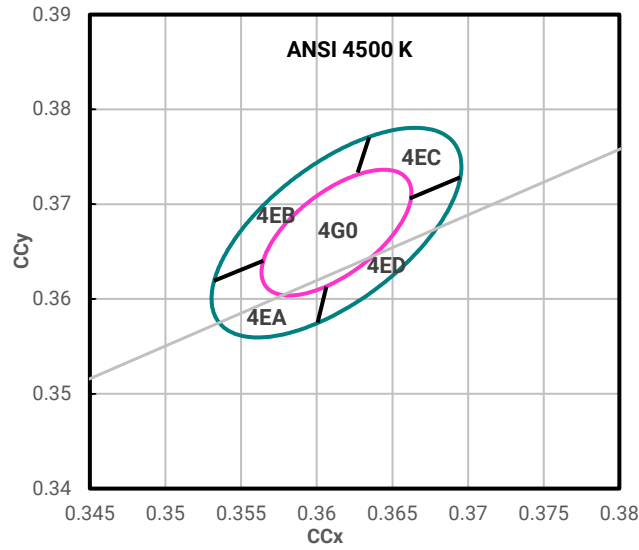

CCT	MacAdam Ellipse	Included Bins	Center Point		Major Axis	Minor Axis	Rotation Angle (°)
			x	y	a	b	
4500 K	3-step	4G0	0.3613	0.3670	0.00756	0.00338	57.58
	5-step	4G0, 4EA, 4EB, 4EC, 4ED	0.3613	0.3670	0.01260	0.00563	57.58

PERFORMANCE GROUPS - CHROMATICITY - CONTINUED

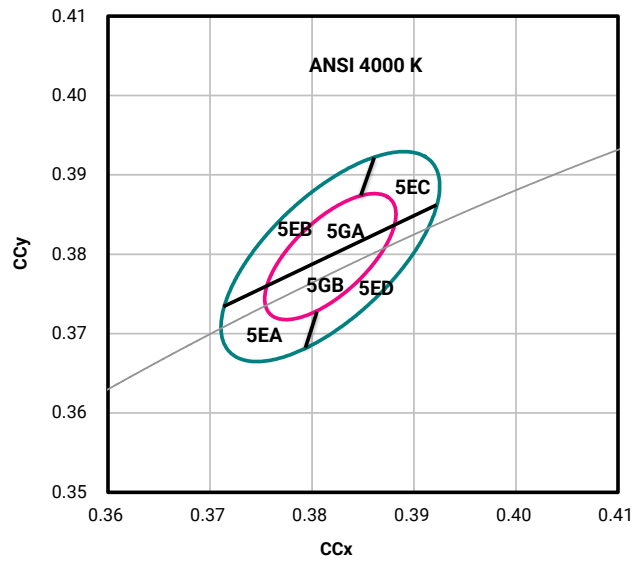

CCT	MacAdam Ellipse	Included Bins	Center Point		Major Axis	Minor Axis	Rotation Angle (°)
			x	y	a	b	
4000 K	3-step	5GA, 5GB	0.3818	0.3797	0.00939	0.00402	53.72
	5-step	5GA, 5GB, 5EA, 5EB, 5EC, 5ED	0.3818	0.3797	0.01565	0.00670	53.72

PERFORMANCE GROUPS - CHROMATICITY - CONTINUED

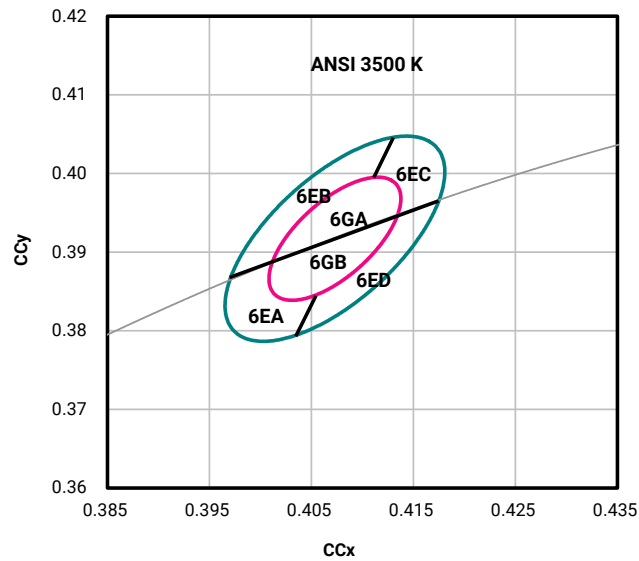

CCT	MacAdam Ellipse	Included Bins	Center Point		Major Axis	Minor Axis	Rotation Angle (°)
			x	y	a	b	
3500 K	3-step	6GA, 6GB	0.4073	0.3917	0.00927	0.00414	53.22
	5-step	6GA, 6GB, 6EA, 6EB, 6EC, 6ED	0.4073	0.3917	0.01545	0.00690	53.22

PERFORMANCE GROUPS - CHROMATICITY - CONTINUED

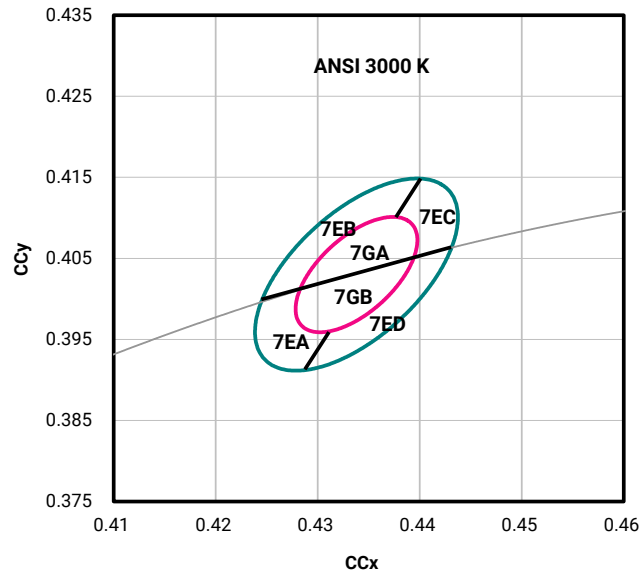

CCT	MacAdam Ellipse	Included Bins	Center Point		Major Axis	Minor Axis	Rotation Angle (°)
			x	y	a	b	
3000 K	3-step	7GA, 7GB	0.4338	0.4030	0.00834	0.00408	53.22
	5-step	7GA, 7GB, 7EA, 7EB, 7EC, 7ED	0.4338	0.4030	0.01390	0.00680	53.22

PERFORMANCE GROUPS - CHROMATICITY - CONTINUED

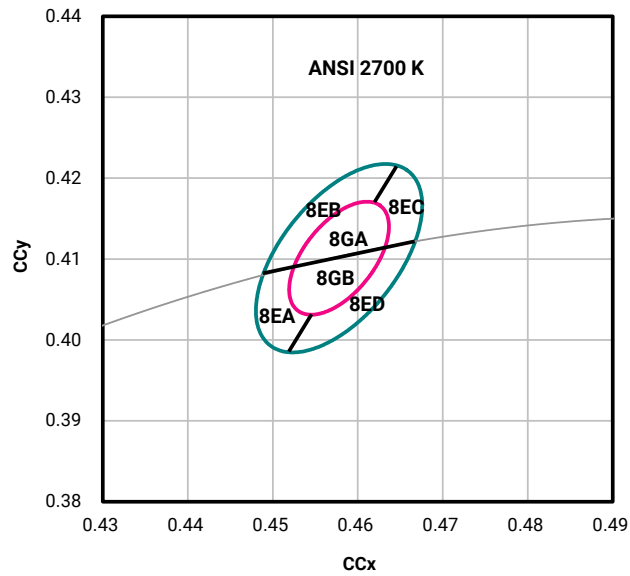

CCT	MacAdam Ellipse	Included Bins	Center Point		Major Axis	Minor Axis	Rotation Angle (°)
			x	y	a	b	
2700 K	3-step	8GA, 8GB	0.4578	0.4101	0.00810	0.00420	53.70
	5-step	8GA, 8GB, 8EA, 8EB, 8EC, 8ED	0.4578	0.4101	0.01350	0.00700	53.70

REFLOW SOLDERING CHARACTERISTICS

In testing, Cree Venture has found J Series 5050 LEDs to be compatible with JEDEC J-STD-020C, using the parameters listed below. As a general guideline, Cree Venture recommends that users follow the recommended soldering profile provided by the manufacturer of the solder paste used, and therefore it is the lamp or luminaire manufacturer’s responsibility to determine applicable soldering requirement.

Note that this general guideline may not apply to all PCB designs and configurations of reflow soldering equipment.

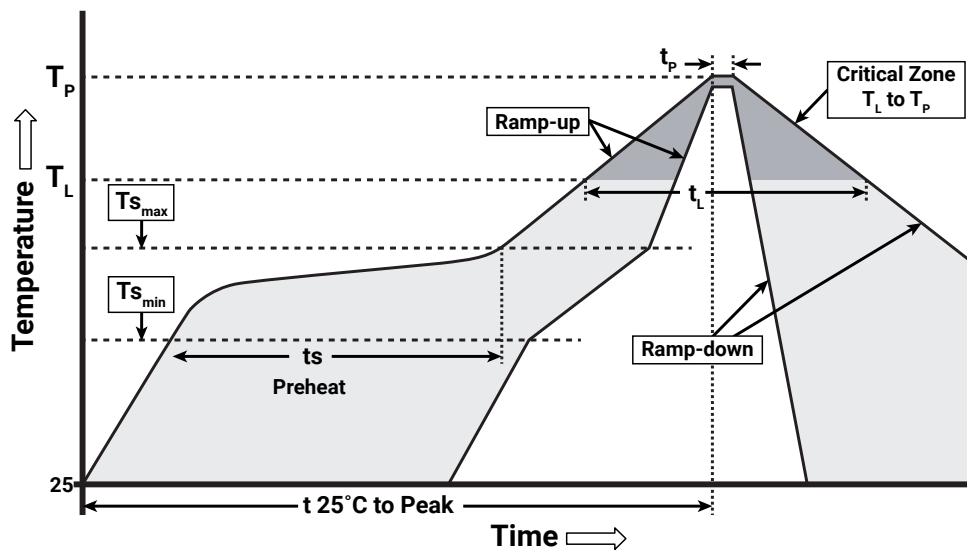

IPC/JEDEC J-STD-020C

Profile Feature	Lead-Free Solder
Temperature Min. ($T_{s_{min}}$)	150 °C
Temperature Max. ($T_{s_{max}}$)	200 °C
Time (t_s) from $T_{s_{min}}$ to $T_{s_{max}}$	60-120 seconds
Ramp-Up Rate (T_L to T_P)	3 °C/second
Liquidus Temperature (T_L)	217 °C
Time (t_L) Maintained Above T_L	60-150 seconds
Peak Package Body Temperature (T_p)	260 °C max.
Time (t_p) Within 5 °C of the Specified Classification Temperature (T_c)	30 seconds max.
Ramp-Down Rate (T_p to T_L)	6 °C/second max.
Time 25 °C to Peak Temperature	8 minutes max.

Note: All temperatures refer to the topside of the package, measured on the package body surface.

NOTES

Measurements

The luminous flux, radiant power, chromaticity, forward voltage and CRI measurements in this document are binning specifications only and solely represent product measurements as of the date of shipment. These measurements will change over time based on a number of factors that are not within Cree Venture’s control and are not intended or provided as operational specifications for the products. Calculated values are provided for informational purposes only and are not intended or provided as specifications.

Pre-Release Qualification Testing

Please read the [J Series Reliability Overview](#) for the details of the pre-release qualification testing for J Series LEDs.

Lumen Maintenance

Cree Venture uses standardized IES LM-80-08 and TM-21-11 methods for collecting long-term data and extrapolating LED lumen maintenance. For information on the specific LM-80 data sets available for this LED, refer to the public [J Series LM-80 results document](#).

Please read the [Thermal Management application note](#) for details on how thermal design, ambient temperature, and drive current affect the LED junction temperature.

Moisture Sensitivity

Cree Venture recommends keeping J Series 5050 LEDs in the provided, resealable moisture-barrier packaging (MBP) until immediately prior to soldering. Unopened MBP that contains J Series 5050 LEDs does not need special storage for moisture sensitivity.

Once the MBP is opened, J Series 5050 LEDs should be handled and stored as MSL 3 per JEDEC J-STD-033, meaning they have limited exposure time before damage to the LED may occur during the soldering operation. The table on the right specifies the maximum exposure time in days depending on temperature and humidity conditions. LEDs with exposure time longer than the specified maximums must be baked according to the baking conditions listed below.

Moisture Sensitivity Level	Temp.	Maximum Percent Relative Humidity				
		50%	60%	70%	80%	90%
Level 3	35 °C	8	5	1	0.5	0.5
Level 3	30 °C	11	7	1	1	1
Level 3	25 °C	14	10	2	1	1
Level 3	20 °C	20	13	2	1	1

Baking Conditions

It is not necessary to bake all J Series 5050 LEDs. Only the LEDs that meet all of the following criteria must be baked:

1. LEDs that have been removed from the original MBP.
2. LEDs that have been exposed to a humid environment longer than listed in the Moisture Sensitivity section above.
3. LEDs that have not been soldered.

LEDs should be baked at 60 °C for 24 hours. LEDs may be baked in the original reels. Remove LEDs from the MBP before baking. Do not bake parts at temperatures higher than 60 °C. This baking operation resets the exposure time as defined in the Moisture Sensitivity section above.

NOTES - CONTINUED

RoHS Compliance

The levels of RoHS restricted materials in this product are below the maximum concentration values (also referred to as the threshold limits) permitted for such substances, or are used in an exempted application, in accordance with EU Directive 2011/65/EC (RoHS2), as implemented January 2, 2013. RoHS Declarations for this product can be obtained from your Cree representative or from the [Product Ecology](#) section of the Cree website.

REACH Compliance

REACH substances of very high concern (SVHCs) information is available for this product. Since the European Chemical Agency (ECHA) has published notice of their intent to frequently revise the SVHC listing for the foreseeable future, please contact a Cree representative to insure you get the most up-to-date REACH SVHC Declaration. REACH banned substance information (REACH Article 67) is also available upon request.

UL® Recognized Component

This product meets the requirements to be considered a UL Recognized Component with Level 4 enclosure consideration. The LED package or a portion thereof has been investigated as a fire and electrical enclosure per ANSI/UL 8750.

Vision Advisory

WARNING: Do not look at an exposed lamp in operation. Eye injury can result. For more information about LEDs and eye safety, please refer to the [J Series LED Eye Safety application note](#).

MECHANICAL DIMENSIONS

Thermal vias, if present, are not shown on these drawings.
All measurements are ±0.2 mm unless otherwise indicated.

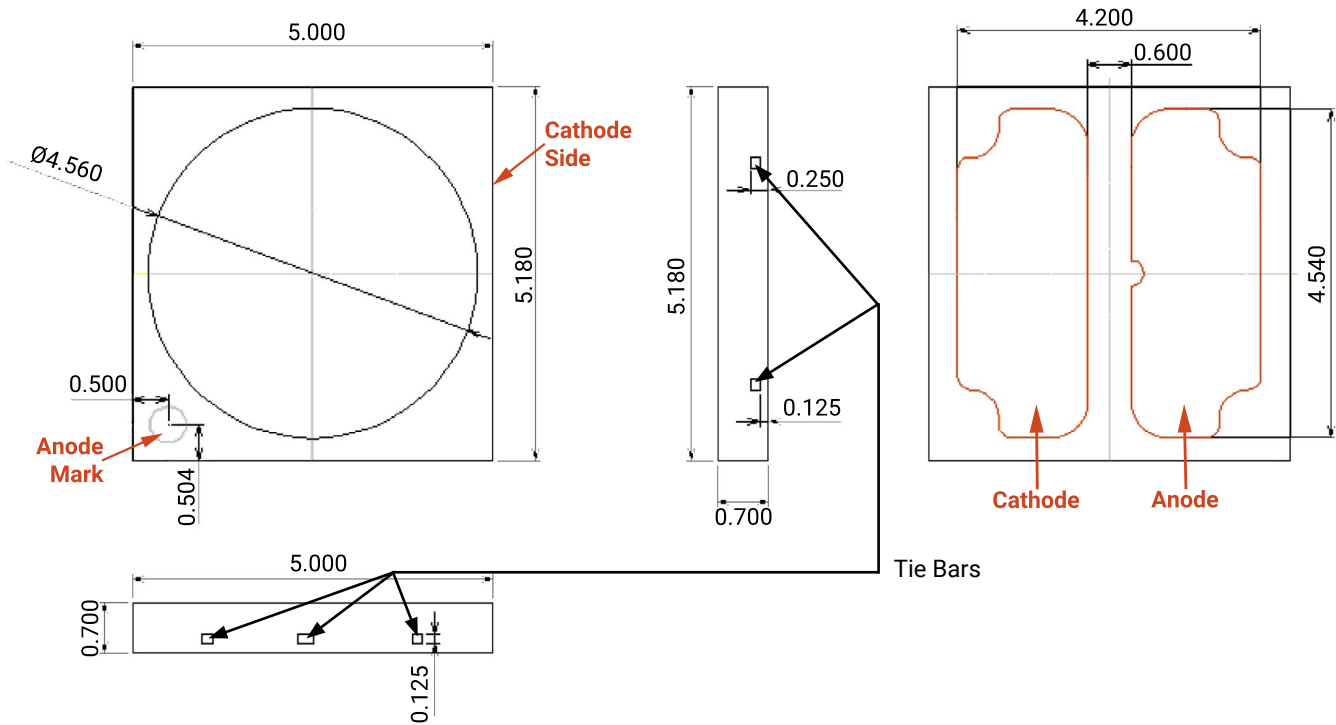

All measurements are ±0.1 mm unless otherwise indicated.

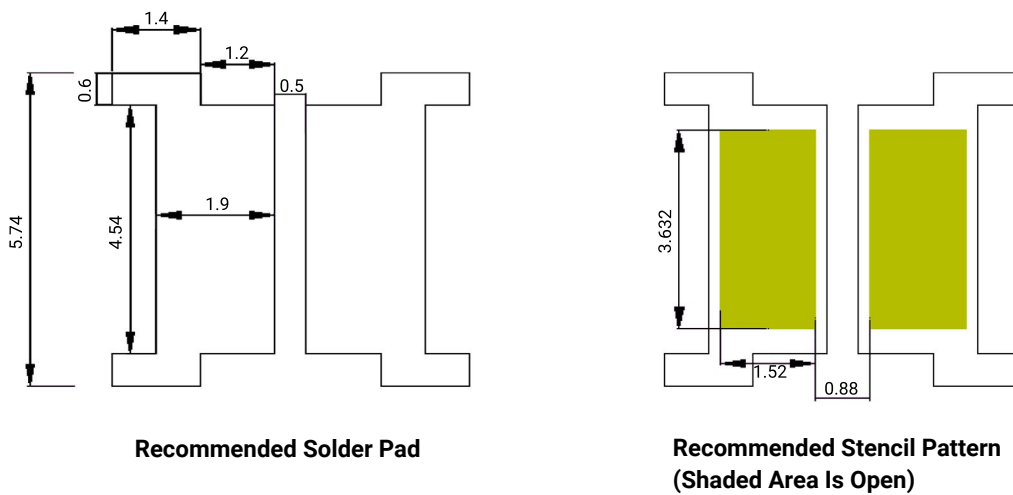

PACKAGING

Unpackaged Reel

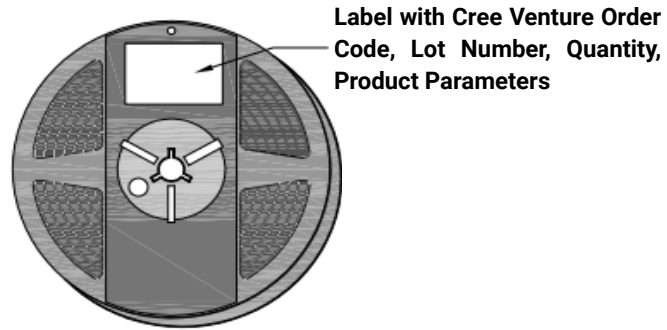

Packaged Reel

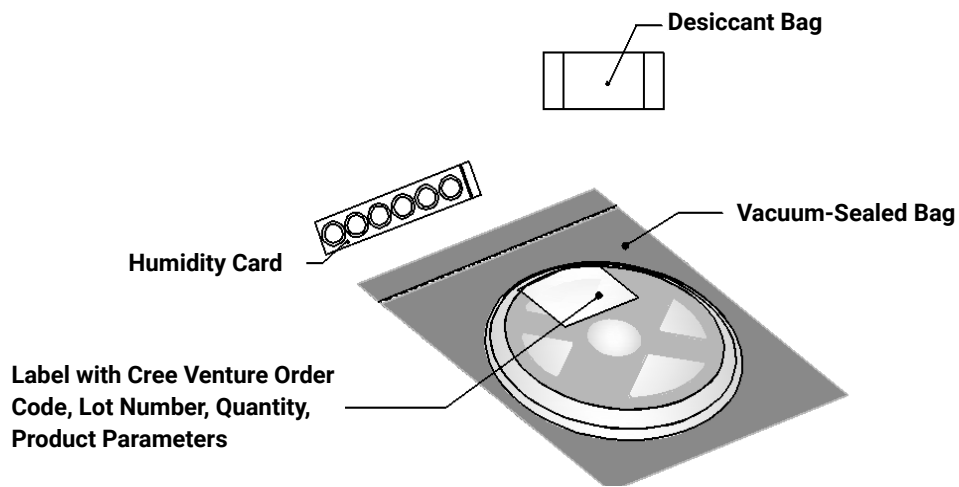

PACKAGING - CONTINUED

J Series 5050 LEDs are packaged in boxes for shipment. Box sizes and the number of reels per box are as follows.

Box	Box Dimensions	Number of Reels per Box
1	250 x 210 x 30 mm	1
2	250 x 210 x 50 mm	2
3	530 x 230 x 275 mm	32
4	530 x 443 x 275 mm	60

Each box has at least one label (shown as a white square in the diagrams below) showing the order code, lot number, quantity, and product parameters.

Box 1

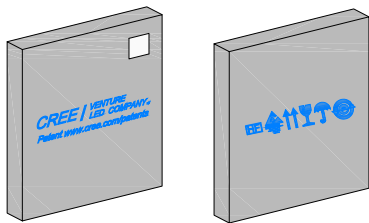

Box 2

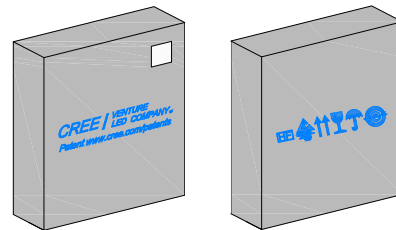

Box 3

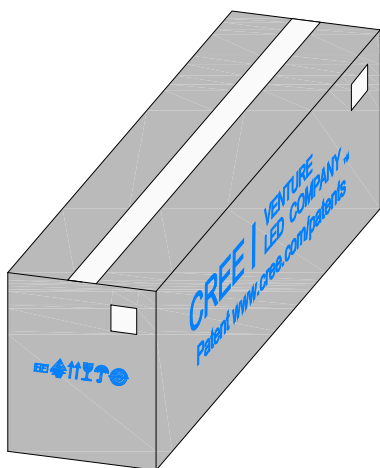

Box 4

