

Specification Approval Sheet

Model: **CR1632-PEN3**

Prepared By/Date	Checked By/Date	Approved By/Date

Customer Approval	Confirmation	Date

Note: 1. Kindly please sign on the above and send it back to us if the sample is approved.
2. Kindly please contact us as soon as possible if the sample isn't approved. Thanks!

Great Power Battery (H.K.) Co. Ltd.

Add : RM.I , 13/F., WINNER BLDG., 36 MAN YUE STREET, HUNG HOM, KOWLOON. HONG KONG

E-MAIL: rebecca@greatpowerhk.net

Tel: (852) 23346730 Fax: (852) 23346756

1. Scope

This specification is suitable for the performance of the GREAT POWER *Lithium and Manganese Dioxide* battery.

2. Model

CR1632 120mAh

3. Reference Document

IEC60086-2: 2001 Primary batteries-Part 2: Physical and technological specifications, MOD

GB 8897.2: 2005 Primary batteries-Part 2: Physical and technological specifications

4. Specification

No.	Items	Specification	
1	Nominal Voltage	3.0 V	
2	Capacity (Discharge Current 1mA to 2.0V)	Nominal	120 mAh
		Minimum	108 mAh
3	Max. Discharge Current	Continuous	2.0 mA
		Pulse	15.0 mA
4	Discharge Cut-off Voltage	2.0 V	
5	Weight	Approx. 2 g	
6	Operating Temperature	-20 °C to 60 °C	
7	Storage Temperature	20 °C to 25 °C	
8	Relative humidity	50±10%	
9	Period of Validity	2 years	
10			

5. Test Conditions and Performance

规格参数 SPECIFICATIONS

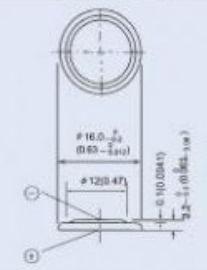

编号 Model No.	CR1632	结构图 Dimensions(mm)
标称电压 Nominal Voltage	3(V)	
标称容量 Nominal Capacity	120(mAh)	
标准电阻 Load Resistance	15(KΩ)	
重量 Weight	2.3(g)	
使用温度 Using Temperature	-20℃ - 60℃	

标准曲线 STANDARD CHARACTERISTICS

定电阻放电曲线

Discharge Characteristics

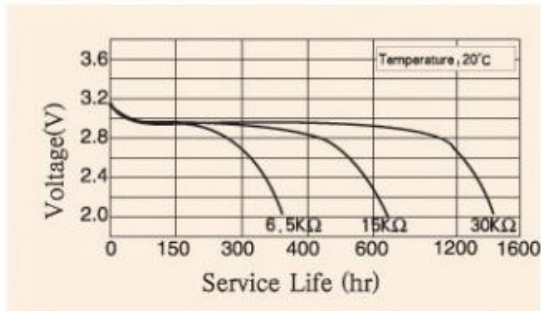

温度放电曲线

Temperature Characteristics

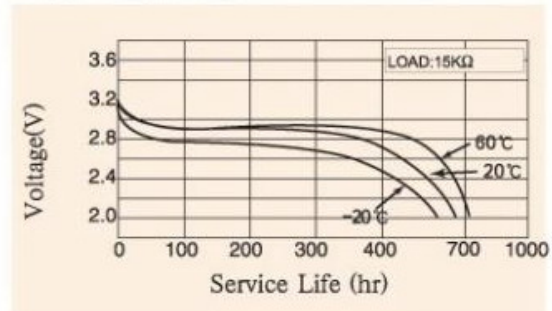

电阻容量曲线

Load-capacity

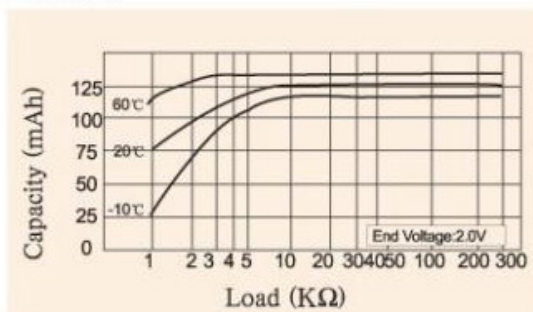

脉冲放电曲线

Pulse Discharge Characteristics

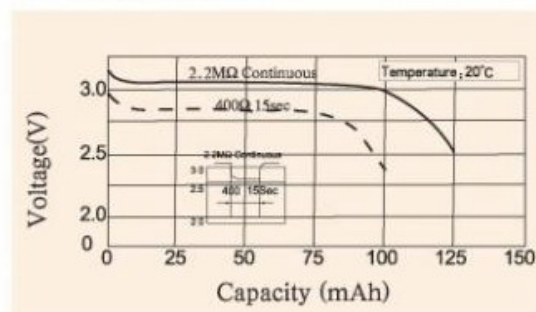

5. Drawing (unit: mm)

【Diagram paper】007

CR1632-PEN3 / Yellow PVC Insulation

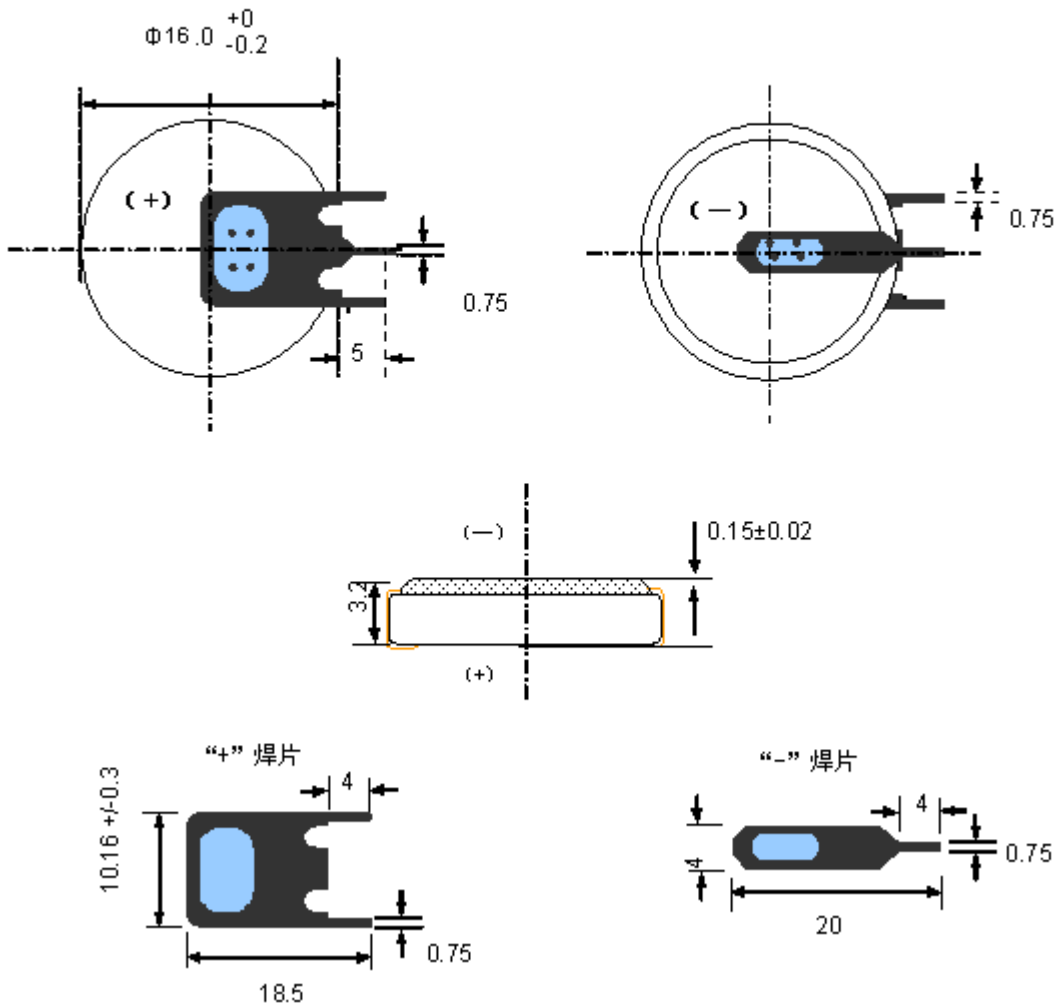

Specifications:

Part Number : CR1632-PEN3

Type: Lithium Manganese Dioxide Button Cell

Voltage: 3 Volts

Nominal Capacity: 120 mAh

Dimensions: 16mm diameter x 3.2mm height

With 3 pins

(Tabs must be have 4 points in the negative and positive pole, according to the drawing.)

*PVC Cover (Yellow)

6. Cautions in use

To ensure proper use of the battery please read the manual carefully before using it.

.Handling

- Do not expose to, dispose of the battery in fire.
- Do not put the battery in a charger or equipment with wrong terminals connected.
- Avoid shorting the battery
- Avoid excessive physical shock or vibration.
- Do not disassemble or deform the battery.
- Do not immerse in water.
- Do not use the battery mixed with other different make, type, or model batteries.
- Keep out of the reach of children.

.Storage

- Store the battery in a cool, dry and well-ventilated area.

.Disposal

- Regulations vary for different countries.
- Dispose of in accordance with local regulations.

7. Battery Terminal Soldering

7.1) CR1632 cell Usable Temperature Range : - 20 C ~ + 60 C

7.2) Storage Temperature Range : 0 C ~ +35 C

7.3) Terminals - Materials of Positive electrode : BA Stainless Steel
- Negative electrode : BA Stainless Steel

7.4) Soldering

Do not apply solder directly to the cell because heat of solder will damage the gaslet or separator, and it might cause electrolyte liquid leakage or bursting. The standard specifications for terminal -mounted cells which can be mounted directly to printed boards are available. Please contact us for situations not covered by standard specifications such as shape of terminals or mounting intervals

7.5) Manual solder mounting

Perform within times specified below soldering iron type temperature
within 3 sec at 350 C
within 5 sec at 260 C

7.6) Dip solder mounting

Place a heat shield such as a printed circuit board between the battery and the solar tank. Be sure to maintain a soldering tank temperature of 260C, and dipping should be restricted to a maximum of 5 seconds.

Make sure that the temperature of the cell does not exceed 85C when the printed circuit board is excessively heated.

When using an organic solvent ego clean the printed circuit boards after dipping, do not use a chloride-base solvent.

Momentarily shorting the cell when dipping will lower voltage.

Charge as prescribed before checking electrical characteristics.

Note that a solder reflow vat cannot be used.

7.7) Do not use reflow soldering for mounting

7.8) Wave soldering

When a battery is mounted onto a PC Board using tabs, and then dipped in a Solder bath, the battery is temporarily short circuited. This is required for the voltage To recover even for slight shorts. Note that if its electrical characteristics are measured While the battery is recovering, the battery may appear to be defective. The recovery Characteristics of the voltage after the slight short the show in Fig. 1. The relationship Between the short-time and the reduction in capacity is shown in Fig.2. keep the Dipping time below 5 seconds. If the battery drops into the solder bath during dipping, Rapid heating may caused an explosion.

Extreme care must be taken to prevent dropping the battery.

The cleaning solution used to clean the PC Board after dipping into the solder bath May affect the battery.

Please do not clean cells and batteries with water or corrosive.

When using an organic solvent to clean the printed circuit boards,
After dipping, do not use a chloride-based solvent.

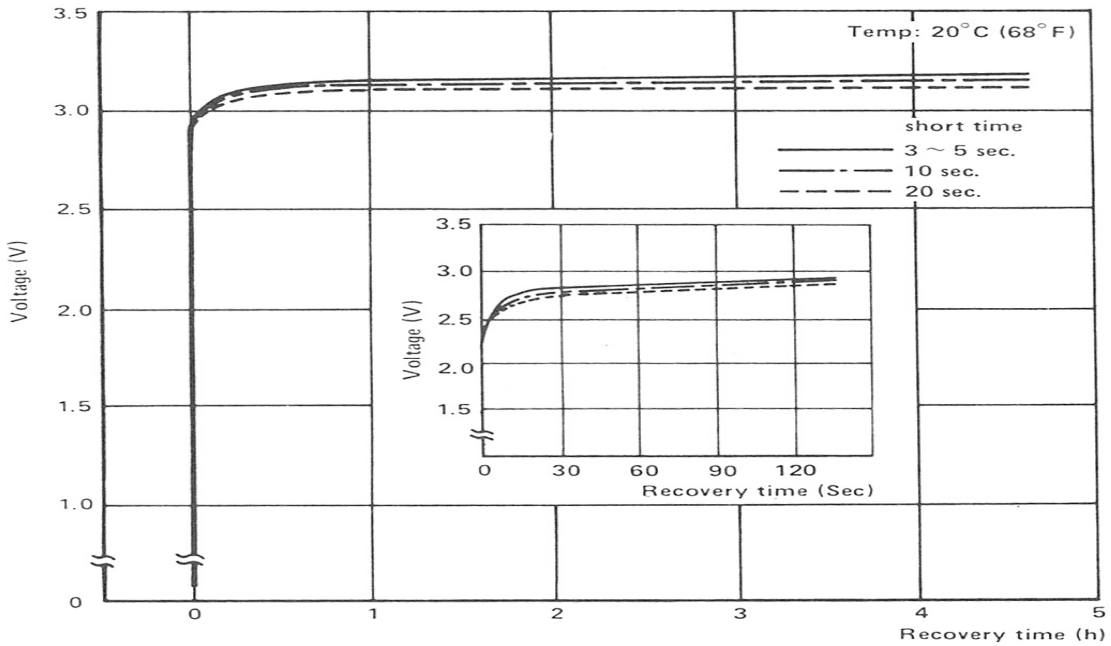

Fig. 1 Voltage recovery characteristics after short test

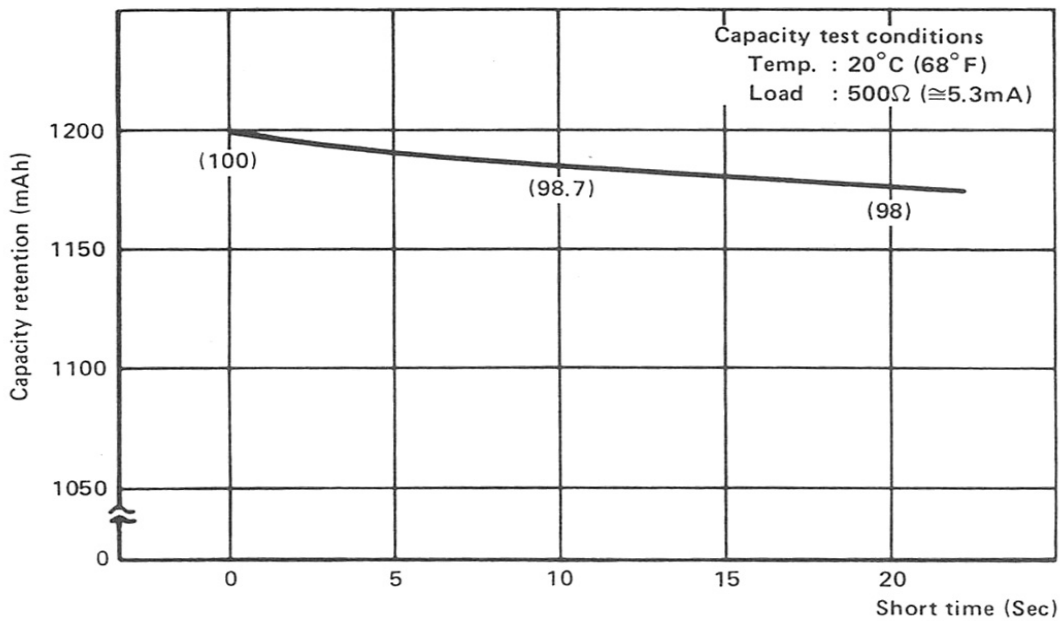

Fig. 2 Capacity retention vs. Short time

8. Do not heat batteries

When lithium batteries are heated above 100 C (212 F),
The resin used in seals, separators and other parts may be damaged,
Causing electrolyte leaks and internal short circuits
Which may lead to fire or explosion.

9. Note

Any other items which are not covered in this specification shall be agreed by both parties.