



健隆投資有限公司
STRONG BASE INVESTMENT LTD.

Unit 17, 11/F., Hewlett Centre, 52-54 Hoi Yuen Road, Kwun Tong, Kowloon, Hong Kong.
Tel: (852) 2793 3293 Fax: (852) 2793 3096



Approval Sheet
(確認書)

編號 Ref. No.	
日期 Issued Date	2018-5-11

公司名稱 : _____
Company Name

產品編號 : 5R3HC-10-P4
Part No.

產品種類 : LED-LAMP
Category

產品描述 : 5MM/HIGH BRIGHT RED , WATER CLEAR
Description

客戶產品編號 : _____
Customer No.

備注 : _____
Remarks

STRONG BASE			
ISSUER	APPROVER	CHECKER	ENGINEER
	朱美丽	覃寿芝	高雪

Authorized Signature 客戶簽字				
部門 Department				
簽字 Signature				

工廠名稱: 宇之亮電子(深圳)有限公司
工廠地址: 廣東省深圳市龍崗區橫崗鎮荷坳村金源工業區
Company Name: Pretty Light (Shen Zhen) Limited
Factory Address: jin-Yuan, Industrial Zone He-Ao Cun, Heng-Gang
Zhen Long-Gang Area, Shen-Zhen City,
TEL: (755) 8976 6931 2862 5421 FAX: (755) 28684819 2862 5922

PART NO. : 5R3HC-10-P4

DATE : 5 September 2018

5MM/HIGH BRIGHT RED ,WATER CLEAR

SPECIFICATION

ABSOLUTE MAXIMUM RATING (Ta=25°C)

Item	Symbol	Rating	Unit
Power Dissipation	P _D	80	mW
Forward Current	I _F	20	mA
Peak Forward Current (1/10 Duty Cycle, 0.1 ms Pulse Width)	I _{FP}	100	mA
Reverse Voltage	V _R	5	V
Operating Temperature	T _{opr}	-40~+85	°C
Storage Temperature	T _{stg}	-40~+100	°C

ELECTRICAL/OPTICAL CHARACTERISTICS RATING (Ta=25°C)

Item	Symbol	Test Conditions	Rating			Unit
			Min.	Typ.	Max.	
Forward Voltage	V _F	I _F =20mA	1.7	2.1	2.4	V
Reverse Current	I _R	V _R =5V	---	---	10	μA
Luminous Intensity	I _v	I _F =20mA	---	350	---	mcd
Dominant Wave Length	λ _d	I _F =20mA	---	640	---	nm
Viewing Angle 2 θ _{1/2}	2 θ _{1/2}	I _F =20mA	20°			deg.

Notes:-

- 1) θ_{1/2} is the off-axis angle where the luminous intensity is half the optical centerline value.

Soldering Conditions : Soldering Temp. ≤ 260°C

Soldering Time ≤ 5 Sec.



Caution : ESD protection measures shall be considered and taken in the initial design stage, because static electricity and surge could damage the LED.

A wrist band or an anti-electrostatic glove should be used when handling Electrostatic Sensitive Devices.

PART NO. : 5R3HC-10-P4

DATE : 5 September 2018

5MM/HIGH BRIGHT RED ,WATER CLEAR

PACKAGE DIMENSION

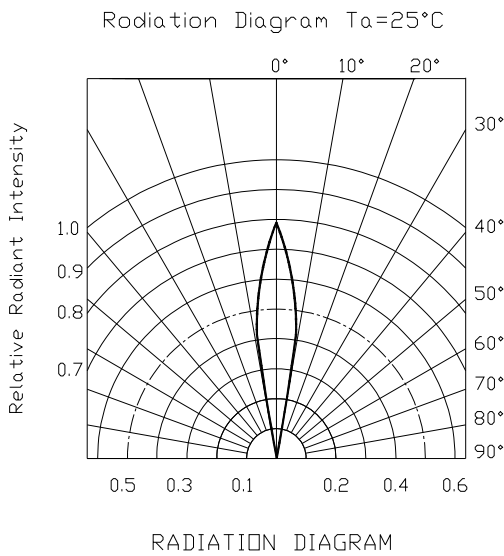

Item	Materials
Resin(Mold)	Epoxy Resin
Lead Frame	Copper Alloy

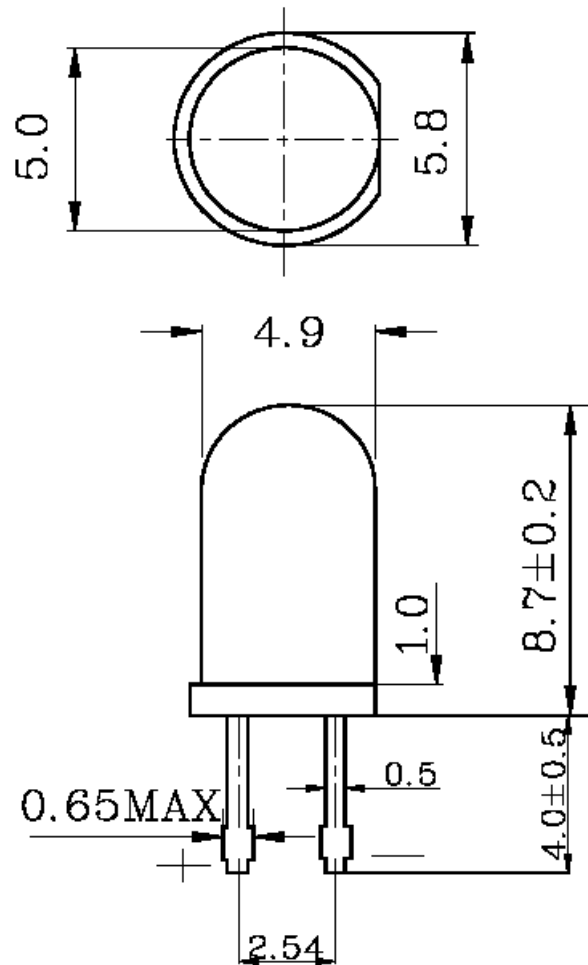

Tolerance: ± 0.25(0.01)
Unit: mm(inch)

Part Number	Emitting Color	Lens Type
5R3HC-10-P4	RED	WATER CLEAR

PART NO. : 5R3HC-10-P4

DATE : 5 September 2018

5MM/HIGH BRIGHT RED ,WATER CLEAR

Typical Electrical/Optical Characteristics Curves

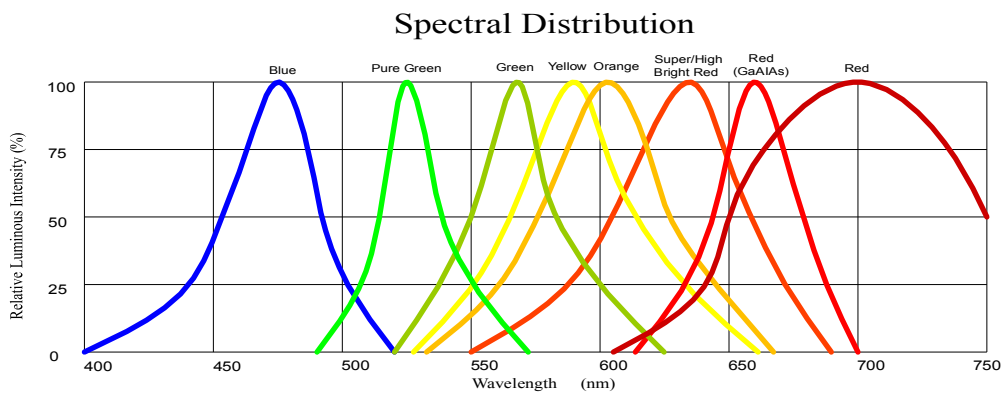

Fig1.Forward Current vs.Forward Voltage

Fig2.Relative Intensity vs. Forward Current

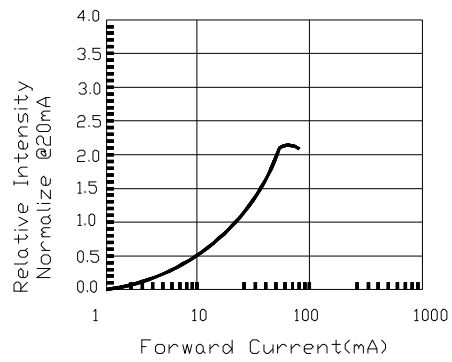
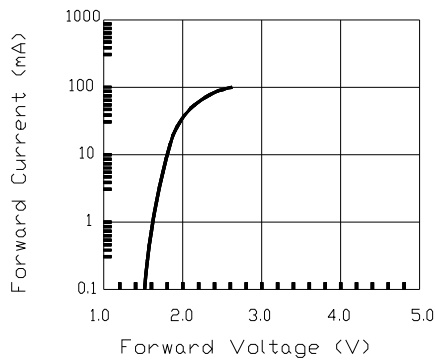
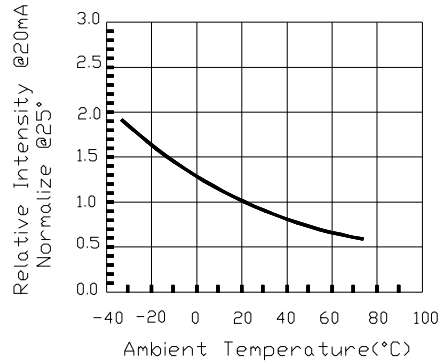
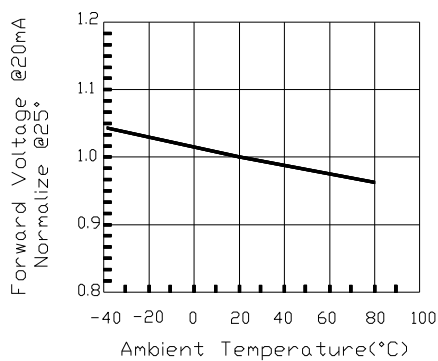

Fig3.Forward Voltage vs. Temperature

Fig4.Relative Intensity vs. Temperature





健隆投資有限公司

STRONG BASE INVESTMENT LTD.

Unit 17, 11/F., Hewlett Centre, 52-54 Hoi Yuen Road, Kwun Tong, Kowloon, Hong Kong.

Tel: (852) 2793 3293

Fax: (852) 2793 3096

email: inquiry@strongbase.com



PART NO. : 5R3HC-10-P4

DATE : 5 September 2018

5MM/HIGH BRIGHT RED ,WATER CLEAR

LED lamp use explain

If there are 2 lights lamp use, according to the (PRETTY LIGHT) each small packaging labeled BIN to separate the use.

此产品在多颗使用时, 需按照字之亮每小包上标示的 BIN 级来分开使用