

Old P/N.:2001 Series

2.0mm Terminal / Housing / Wafer SMT Straight / SMT R/A Type

Specifications

Current Rating: 2A AC,DC
 Voltage Rating: 100V AC,DC
 Temperature Range: -25°C to +85°C
 Contact Resistance: 10mΩ Max
 Insulation Resistance: 1000MΩ Min
 Withstanding Voltage: 800V AC/minute
 Terminal: Brass / Gold Plated
 Solder Tabs: Brass / Gold Plated
 Material: Housing: Nylon 66, UL94V-0
 Wafer: Nylon 6T, UL94V-0

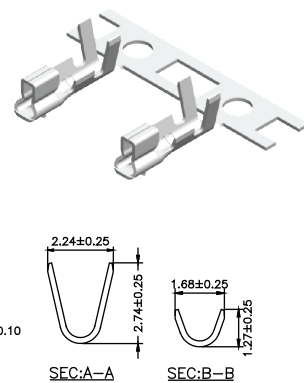
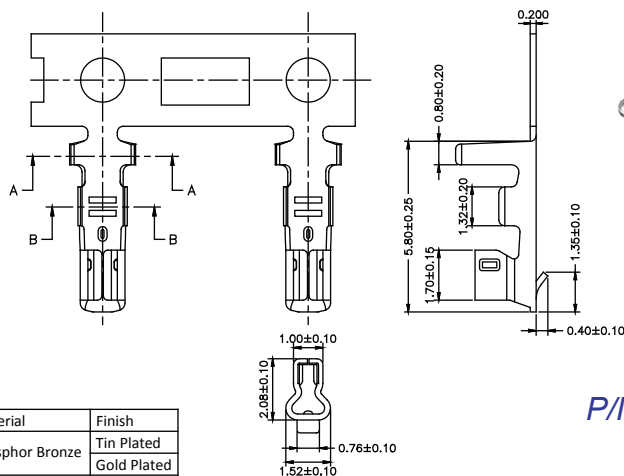

P/N.:5T2001N-PXR-01

T0: Tin plated
 G0: Gold plated

Part No.	Wire Range	Insulation O.D.	Material	Finish
5T2001N-PT0	#24-#30	1.50mm(Max)	Phosphor Bronze	Tin Plated
5T2001N-PG0				Gold Plated

No. of Contacts	Dimensions	
	A	B
2	2.00	5.80
3	4.00	7.80
4	6.00	9.80
5	8.00	11.80
6	10.00	13.80
7	12.00	15.80
8	14.00	17.80
9	16.00	19.80
10	18.00	21.80
11	20.00	23.80
12	22.00	25.80
13	24.00	27.80
14	26.00	29.80
15	28.00	31.80
16	30.00	33.80

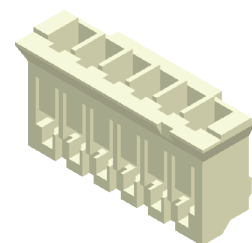
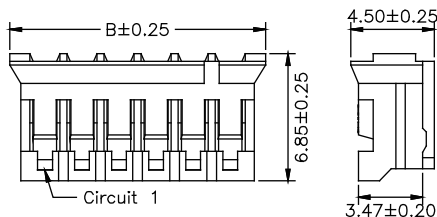
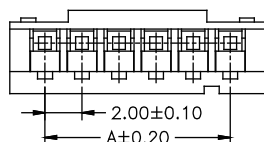

P/N.:5H2001N0-1XXWBL00-01

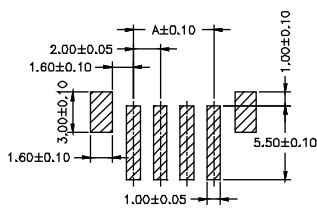

No. of Contacts	Dimensions	
	A	B
2	2.00	8.00
3	4.00	10.00
4	6.00	12.00
5	8.00	14.00
6	10.00	16.00
7	12.00	18.00
8	14.00	20.00
9	16.00	22.00
10	18.00	24.00
11	20.00	26.00
12	22.00	28.00
13	24.00	30.00
14	26.00	32.00
15	28.00	34.00
16	30.00	36.00

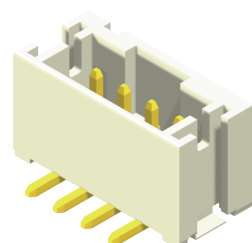
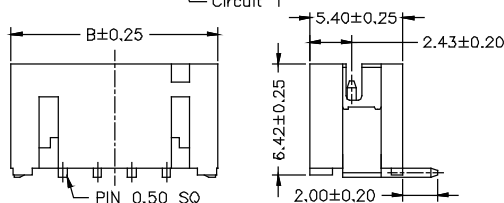
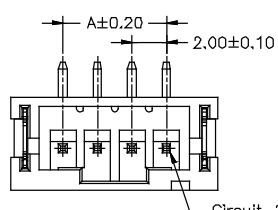

P/N.:5W2001G0-1XXG0WRU-01

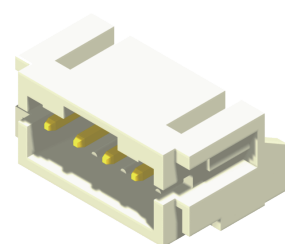
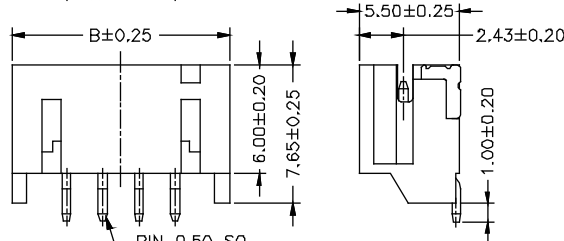
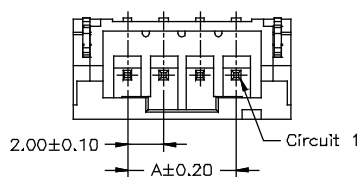
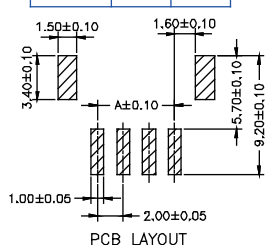

P/N.:5W2001H0-1XXG0WRU-01