



光之宝
lightBO

深圳光之宝科技有限公司

Shenzhen Guangzhibao Technology Co.,Ltd.

SPECIFICATION FOR APPROVAL

DESCRIPTION : 3-Digit 0.54" Common Cathode Red 14-Segment LED Display

PART NUMBER : LB30541LR1B

CUSTOMER : _____

拟制 (PREPARED BY) : LI PEIWEI

审核 (CHECKED BY) : WEN WU

批准 (APPROVED BY) : LIU ZHIYONG

日期 (DATE): 2018.07.06

客户承认 (APPROVED BY CUSTOMER):

签名 (SIGNED): _____ 职务 (TITLE): _____ 日期 (DATE): _____

Add:Room 517,5/F, Building 63 ,Jinlong Industrial Town , No. 88, Daxin Road,

Nanshan District, Shenzhen,Guangdong 518052 China

Tel: (86 755)8398 3496

Fax: (86 755)8398 3484

Web: www.lightbo.cn

E-mail: lightbo@lightbo.cn

LB30541

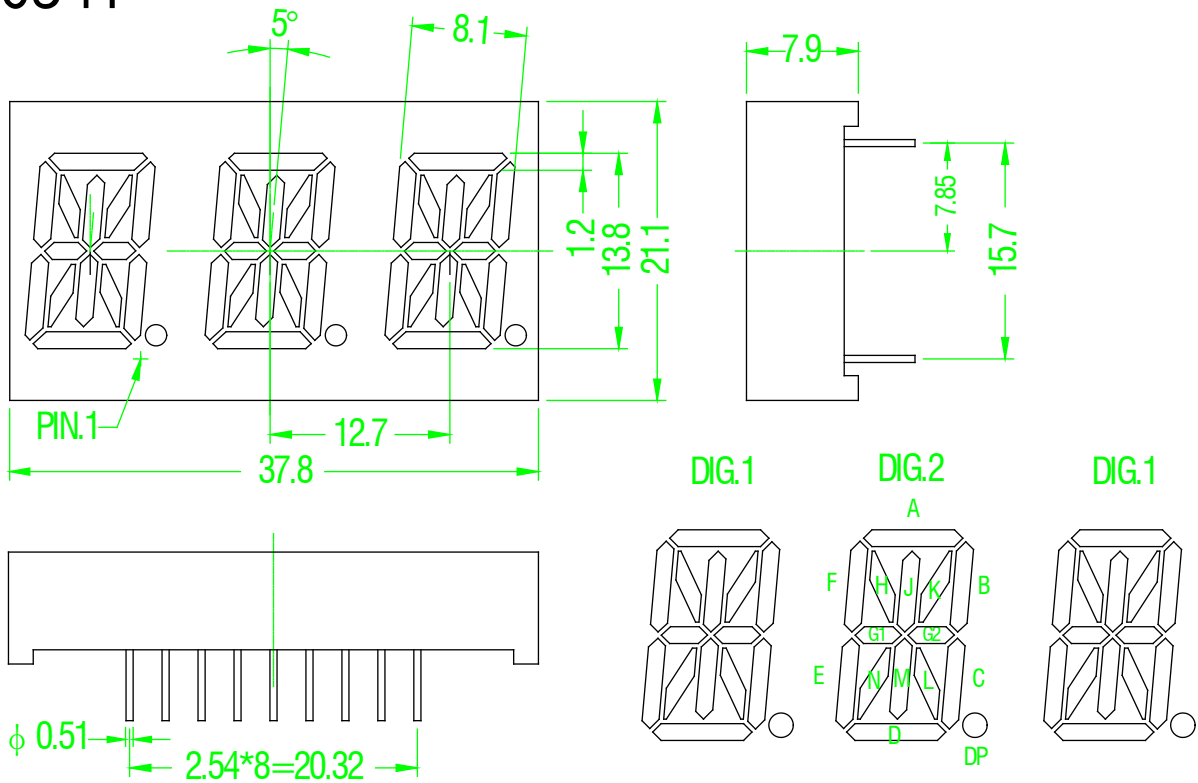

CODE L

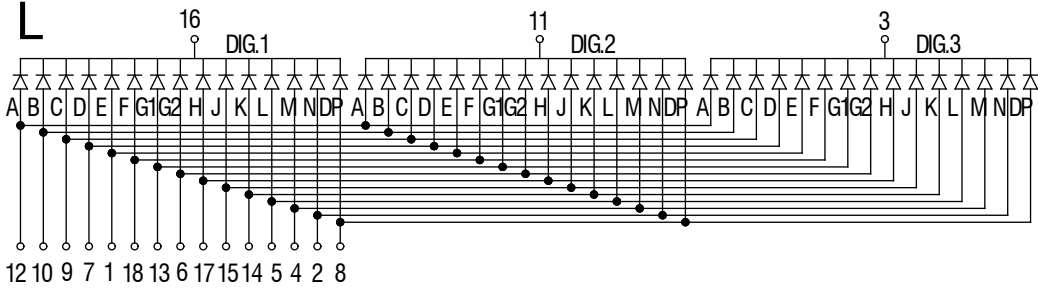

CODE I

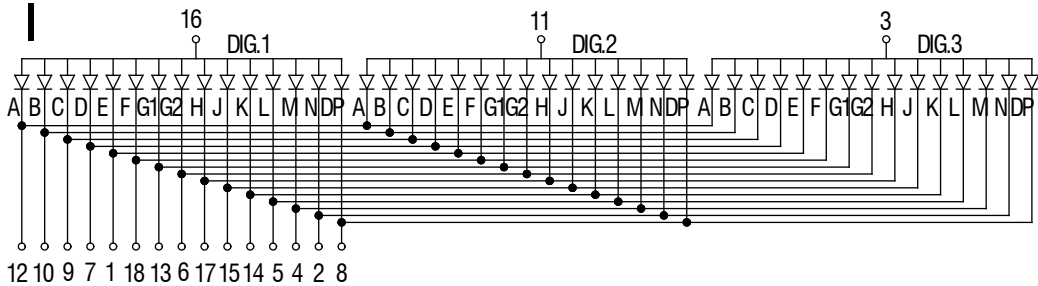



深圳光之宝科技有限公司

Shenzhen Guangzhibao Technology Co.,Ltd.

LB30541LR1B Triple-Digit 14-Segment LED Display

一 . Characteristics

01. Package Dimensions :37.8*21.1*7.9 mm
02. Digit height : 13.8 mm(0.54 inch)
03. Polarity: Common Cathode
04. Emitting colour: Super bright red
05. White Segments Black surface
06. High luminous intensity and reliability
07. Low current operation
08. Stable performance
09. Continous uniform segments
10. Easy assembly
11. IC Compatible
12. Long lifetime
13. Meet RoHS

二 . Absolute Maximum Ratings (Ta = 25°C)

Parameter	Symbol	Ratings	Unit
Forward Current (per dice)	I_{PM}	20	mA
Reverse Voltage(per dice)	V_R	5	V
Power Dissipation(per dice)	P_M	45	mW
Operating Temperature Range	T_{opr}	-40~+85	°C
Storage Temperature Range	T_{STg}	-40~+85	°C
Solder Temperature (3 sec)	T_h	260	°C

Fig. 1

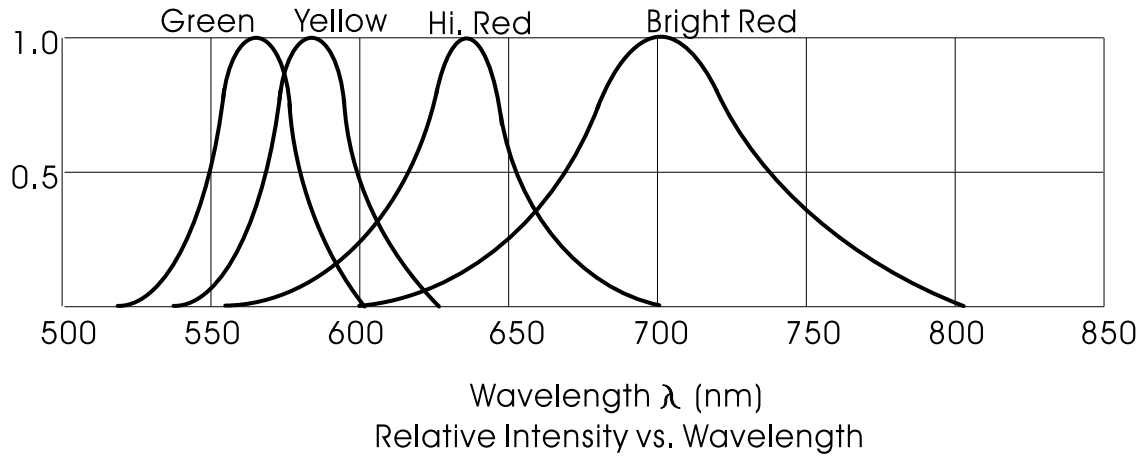

Fig. 2

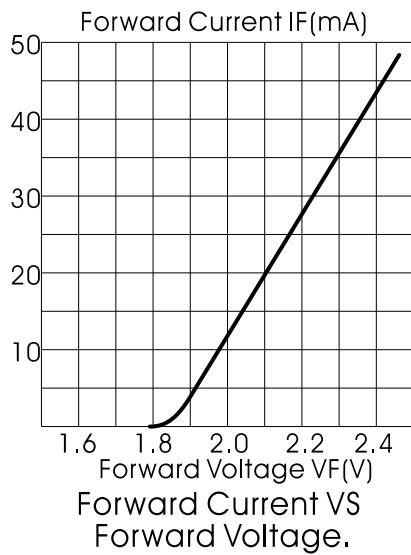

Fig. 3

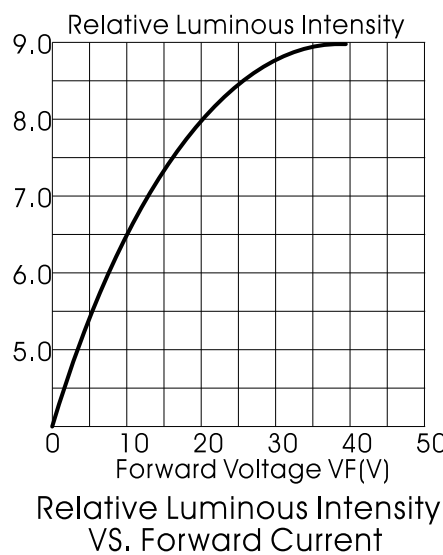
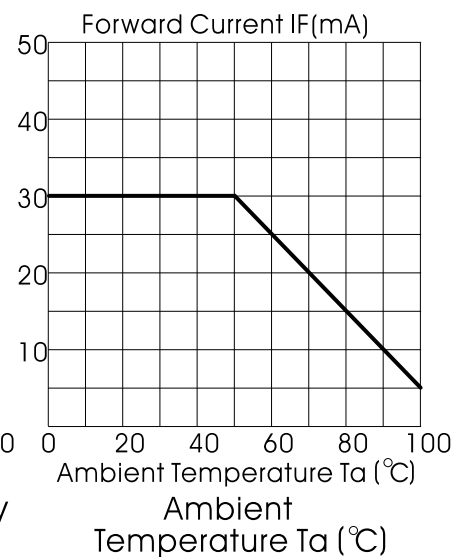

Fig. 4



Code: R-Super Bright Red

Parameter	Symbol	Condition	Min	Typ	Max	Unit
Forward Voltage	V_f	$I_f = 20\mu\text{A}$	1.8		2.5	V
Reverse Voltage	V_r	$I_r = 10\mu\text{A}$	5	-	-	V
Luminous Intensity	I_v	$I_f = 20\text{mA}$	40		50	mcd
Spectrum Width Of Half Value	$\Delta \lambda$	$I_f = 20\text{mA}$		20		nm
Wavelength	$D \lambda$	$I_f = 20\text{mA}$	620		625	nm

LED working lifetime 100,000 hrs
 Absolute Maximum Rating at $T_a = 25^{\circ}\text{C}$