



SPECIFICATION FOR APPROVAL

File No.: Q/FRK 0.GS.E.C42-C16

Product Name Box-type Metallized Polypropylene Film Interference Suppression Capacitor (Class X2)

Product Type MKP62

Product Code C42

Customer

Customer Code

Issue Date 2023-05

Xiamen Faratronic Co. Ltd.			Approved by Customer
Drafted	Checked	Approved	

Xiamen Faratronic Co. Ltd.

Add: 99 Xinyuan Road, Haicang District, Xiamen, China



Marketing/Sales center

TEL: 0086-592-6208620/6208618/6208589/6208505

FAX: 0086-592-6208777

Mail: Vitawang@faratronic.com.cn

michael_lai@faratronic.com.cn

chris@faratronic.com.cn

donny@faratronic.com.cn

Http: www.faratronic.com.cn

*The specification are the property of Xiamen Faratronic Co.Ltd and shall not be copied or used as commercial purposes without permission.



Version history

Current version	Date	Author	Change description

Metallized polypropylene film interference suppression capacitor(Class X2, 305Vac/275Vac)

■ Outline Drawing

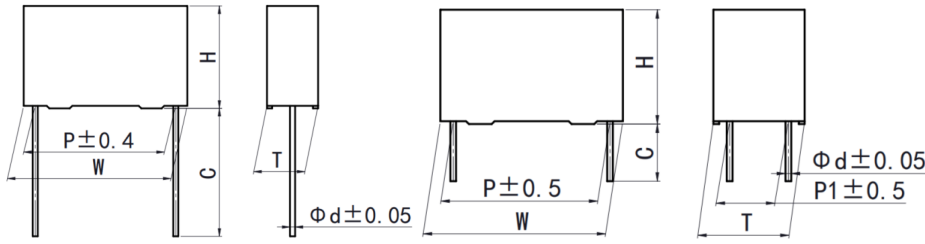

$W \pm 0.4, H \pm 0.4, T \pm 0.4$

$W \pm 1.0, H \pm 1.0, T \pm 1.0$
Square-bottom

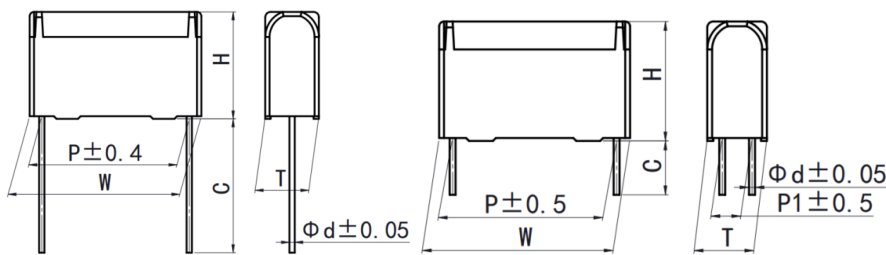

$W \pm 0.4, H \pm 0.4, T \pm 0.4$

$W \pm 1.0, H \pm 1.0, T \pm 1.0$
Arc-bottom

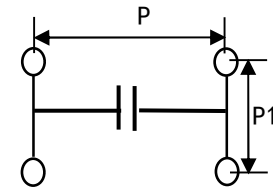

4pins

■ Features

- Metallized polypropylene structure
- Withstanding overvoltage stressing
- Excellent active and passive flame resistant abilities
- Used in across-the-line, interference suppression circuit.

■ Safety Approvals

●		CQC	IEC 60384-14:2013, X2, 305Vac/275Vac, 0.0010 μ F~50.0 μ F, 40/110/56/B Certificate No.: CQC03001002875
●		ENEC-VDE	EN 60384-14:2013+A1 2016, X2, 305Vac/275Vac, 0.0010 μ F ~ 50.0 μ F, 40/110/56/B Certificate No.:40000358
●		UL-CUL	UL 60384-14:2009, CSA E60384-14:09, X2, 305Vac/275Vac, 0.0010 μ F~50.0 μ F, 40/110/56/B Certificate No.:E186600, CCN: FOWX2/8
●		KC	K60384-14(2006-12), X2, 305Vac/275Vac, 0.0010 μ F~3.0 μ F, 40/110/56/B Certificate No.: SU03060-12001A/12002/12003/12004

■ Specifications

Class	Class X2		
Climatic Category / Passive	40/110/56/B		
Operating Temperature Range	-40°C ~ +110°C		
Rated Voltage (U_R)	305Vac/275Vac, 50/60Hz		
Maximum continuous DC voltage	630Vdc		
Capacitance Range	0.0010 μ F~25.0 μ F		
Capacitance Tolerance	\pm 10%(K), \pm 20%(M)		
Voltage Proof	Between Terminals	4.3 U_R (dc), 2s	
	Between Terminals To Case	2 120Vac, 1min	
Insulation Resistance	$R \geq 15\ 000M\Omega$, $C_N \leq 0.33\mu F$ $RC_N \geq 5\ 000s$, $C_N > 0.33\mu F$ (20°C, 100V, 1min)		
Dissipation Factor	$0.0010\mu F \leq C_N < 0.010\mu F$	$\leq 20 \times 10^{-4}$ (1kHz, 20°C)	$\leq 20 \times 10^{-4}$ (10kHz, 20°C)
	$0.010\mu F \leq C_N < 0.47\mu F$	$\leq 10 \times 10^{-4}$ (1kHz, 20°C)	$\leq 20 \times 10^{-4}$ (10kHz, 20°C)
	$0.47\mu F \leq C_N \leq 1.0\mu F$	$\leq 20 \times 10^{-4}$ (1kHz, 20°C)	$\leq 40 \times 10^{-4}$ (10kHz, 20°C)
	$1.0\mu F < C_N \leq 10.0\mu F$	$\leq 30 \times 10^{-4}$ (1kHz, 20°C)	-----
	$10.0\mu F < C_N \leq 50.0\mu F$	$\leq 40 \times 10^{-4}$ (1kHz, 20°C)	-----
Note: 1.Recommend for max rated supply mains voltage 250Vac application; 2.If used in application which has ripple current applied, recommend to use AC filter series: C6A etc; If have any questions please contact our technical engineer for more detail; 3. For outdoor or severe humidity condition application, recommend to use THB series.			

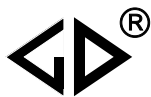

Part number system

The 15 digits part number is formed as follow:

1	2	3	4	5	6	7	8	9	10	11	12	13	14	15
C	4	2												

Digit 1 to 3 Series code

C42=MKP62

Digit 4 to 5 A.C. rated voltage

Q2=305V P2=275V

Digit 6 to 8 Rated capacitance value

For example : 103=10×10³ pF= 0.01μF

Digit 9 Capacitance tolerance

K=±10%, M=±20%

Digit 10 Pitch

3=7.5mm 4=10.0mm 6=15.0mm 9=22.5mm

B=27.5mm F=37.5mm M=52.5mm

Digit 11 Internal use

Digit 12 to 15 Lead form and packaging code

Table1 Lead form and packaging code

Digit 12		Digit 13		Digit 14		Digit 15	
code	explanation	code	explanation	code	explanation	code	explanation
A	ammo-pack	3 4 6	F=7.5mm F=10.0mm F=15.0mm	0	Straight	1 5	each cap. among two consecutive holes P3=12.7mm,H=18.5mm (For P=7.5mm) P3=25.4mm;H=18.5mm (For pitch=10/15mm) (Detail parameter refer to page 11)
C	straight lead "C" in the figure above	code	explanation			0	Length tolerance ± 0.5mm or standard length
		00	standard lead length (18mm~26mm)				
		32	lead length 3.2mm				
		35	lead length 3.5mm				
		40	lead length 4.0mm				
		45	lead length 4.5mm			2	Length tolerance ± 0.3mm or standard length
D	Insulated stranded leads	C5	35mm			1	Length tolerance -5 mm~0 mm
E	Insulated solid leads	K0	100mm				
		K2	120mm				
M	Insulated stranded leads Box with mounting foot	L0	200mm			3	Length tolerance 0 mm~+10mm
			Note 1 : This length includes the stripping parts. Note 2: Normally, for P≥27.5 Caps can choice Insulated leads.				
T	P1=20.3mm±0.5mm	38	lead length 3.8mm			0	Length tolerance ± 0.5mm or standard length
3	P1=20mm±0.5mm	45	lead length 4.5mm				

Note: Recommend short lead due to long lead could deform easily.



■ Dimensions(mm)

High performance version

305Vac/275Vac [#]						
C _N (μF)	W	H	T	P	d	Part number
0.022	10.5	9.0	4.0	7.5	0.6	C42Q2223-30****
0.027	10.5	11.0	5.0	7.5	0.6	C42Q2273-30****
0.033	10.5	11.0	5.0	7.5	0.6	C42Q2333-30****
0.039	10.5	12.0	6.0	7.5	0.6	C42Q2393-30****
0.047	10.5	12.0	6.0	7.5	0.6	C42Q2473-30****
0.033	13.0	11.0	5.0	10.0	0.6	C42Q2333-40****
0.039	13.0	11.0	5.0	10.0	0.6	C42Q2393-40****
0.047	13.0	11.0	5.0	10.0	0.6	C42Q2473-40****
0.056	13.0	11.0	5.0	10.0	0.6	C42Q2563-40****
0.068	13.0	12.0	6.0	10.0	0.6	C42Q2683-40****
0.082	13.0	12.0	6.0	10.0	0.6	C42Q2823-40****
0.12	13.0	14.0	8.0	10.0	0.6	C42Q2124-40****
0.15	13.0	14.0	8.0	10.0	0.6	C42Q2154-40****
0.010	17.5	11.0	5.0	15.0	0.8	C42Q2103-60****
0.012	17.5	11.0	5.0	15.0	0.8	C42Q2123-60****
0.015	17.5	11.0	5.0	15.0	0.8	C42Q2153-60****
0.018	17.5	11.0	5.0	15.0	0.8	C42Q2183-60****
0.022	17.5	11.0	5.0	15.0	0.8	C42Q2223-60****
0.027	17.5	11.0	5.0	15.0	0.8	C42Q2273-60****
0.033	17.5	11.0	5.0	15.0	0.8	C42Q2333-60****
0.039	17.5	11.0	5.0	15.0	0.8	C42Q2393-60****
0.047	17.5	11.0	5.0	15.0	0.8	C42Q2473-60****
0.056	17.5	11.0	5.0	15.0	0.8	C42Q2563-60****
0.068	17.5	11.0	5.0	15.0	0.8	C42Q2683-60****
0.082	17.5	11.0	5.0	15.0	0.8	C42Q2823-60****
0.10	17.5	11.0	5.0	15.0	0.8	C42Q2104-60****
0.12	17.5	12.0	6.0	15.0	0.8	C42Q2124-60****
0.15	17.5	12.0	6.0	15.0	0.8	C42Q2154-60****
0.18	17.5	13.5	7.5	15.0	0.8	C42Q2184-60****
0.22	17.5	13.5	7.5	15.0	0.8	C42Q2224-60****
0.27	17.5	14.5	8.5	15.0	0.8	C42Q2274-60****
0.33	17.5	16.0	10.0	15.0	0.8	C42Q2334-60****
0.39	17.5	19.0	11.0	15.0	0.8	C42Q2394-60****
0.47	17.5	19.0	11.0	15.0	0.8	C42Q2474-60****

305Vac/275Vac [#]						
C _N (μF)	W	H	T	P	d	Part number
0.27	26.5	16.0	7.0	22.5	0.8	C42Q2274-90****
0.33	26.5	16.0	7.0	22.5	0.8	C42Q2334-90****
0.39	26.5	17.0	8.5	22.5	0.8	C42Q2394-90****
0.47	26.5	17.0	8.5	22.5	0.8	C42Q2474-90****
0.56	26.5	18.5	10.0	22.5	0.8	C42Q2564-90****
0.68	26.5	18.5	10.0	22.5	0.8	C42Q2684-90****
0.82	26.5	22.0	12.0	22.5	0.8	C42Q2824-90****
1.0	26.5	22.0	12.0	22.5	0.8	C42Q2105-90****
1.2	26.5	24.5	15.5	22.5	0.8	C42Q2125-90****
1.5	26.5	24.5	15.5	22.5	0.8	C42Q2155-90****
0.82	32.0	20.0	11.0	27.5	0.8	C42Q2824-B0****
1.0	32.0	20.0	11.0	27.5	0.8	C42Q2105-B0****
1.2	32.0	22.0	13.0	27.5	0.8	C42Q2125-B0****
1.5	32.0	22.0	13.0	27.5	0.8	C42Q2155-B0****
1.8	32.0	24.5	15.0	27.5	0.8	C42Q2185-B0****
2.2	32.0	28.0	14.0	27.5	0.8	C42Q2225-B0****
2.7	32.0	33.0	18.0	27.5	0.8	C42Q2275-B0****
3.3	32.0	33.0	18.0	27.5	0.8	C42Q2335-B0****
3.9	32.0	37.0	22.0	27.5	0.8	C42Q2395-B0****
4.7	32.0	37.0	22.0	27.5	0.8	C42Q2475-B0****
1.5	41.0	22.0	11.0	37.5	1.0	C42Q2155-F0****
★1.8	41.0	26.0	12.0	37.5	1.0	C42Q2185-F0****
★2.2M	41.0	26.0	12.0	37.5	1.0	C42Q2225MF0****
2.2K	42.0	28.0	14.0	37.5	1.0	C42Q2225KF0****
2.7	42.0	28.0	14.0	37.5	1.0	C42Q2275-F0****
3.3	41.0	30.0	16.0	37.5	1.0	C42Q2335-F0****
3.9	41.0	32.0	17.0	37.5	1.0	C42Q2395-F0****
4.7	41.0	33.5	18.5	37.5	1.0	C42Q2475-F0****
5.6	41.0	37.0	22.0	37.5	1.0	C42Q2565-F0****
6.8	41.0	37.0	22.0	37.5	1.0	C42Q2685-F0****
8.2	41.0	41.0	26.0	37.5	1.0	C42Q2825-F0****
10.0	41.0	43.0	28.0	37.5	1.0	C42Q2106-F0****

Note: 1. “-” =capacitance tolerance code, M=±20%,K=±10%

2. “****” =lead form and packing code (refer to table 1)

3. “#” when the rated voltage is 275Vac,the digit 4~5 is P2.

4. Not for use in series with the mains, the capacitors for series with the mains, please refer to A.C. Capacitors for Capacitive Divider

5. “★” = Arc bottom of the outer shell.

■ Maximum permissible voltage change per unit of time

Rated Voltage (Vac)	dV/dt(V/us) at 440 Vdc						
	P=7.5mm	P=10mm	P=15mm	P=22.5mm	P=27.5mm	P=37.5mm	P=52.5mm
305/275	500	500	400	200	150	100	50

Note:

1. Rated voltage pulse slope $(dV/dt)_R$ at rated voltage.
2. If the working voltage (U) is lower than the rated voltage (U_R) , the capacitor can be worked at a higher dV/dt . In this case, the maximum allowed dV/dt is obtain by multiplying the right value with U_R/U .

■ Impedance Vs. Frequency

TYPICAL GRAPHS

$Z=f(f)$ Typical values

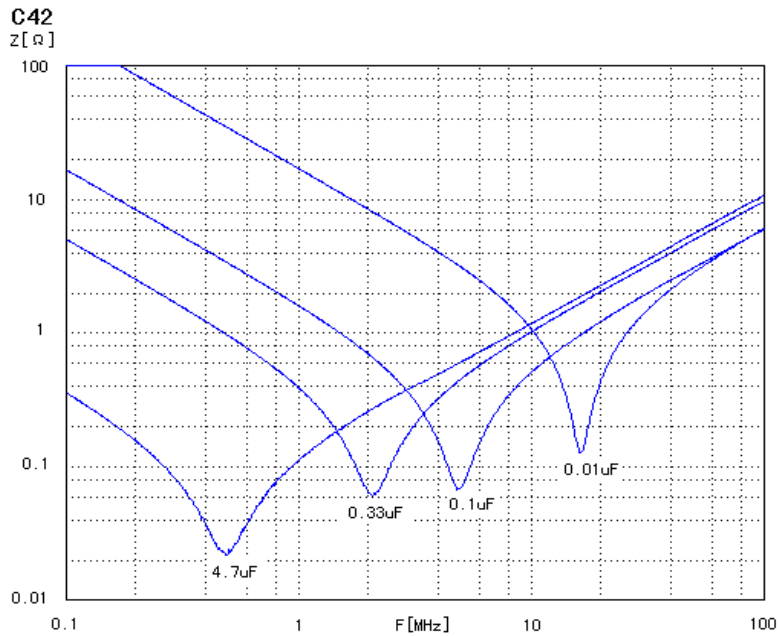



■ Test Method And Performance (IEC 60384-14)

Group	Item	Conditions of test	Performance requirements
A1	4.1 Visual examination	Dimensions: gauging by vernier caliper	No visible damage & legible marking
	4.1Dimensions(Gauging)		Fit detail specification
A2	4.2.2 Capacitance	Measuring frequency: Capacitance: 1kHz Tangent of loss angle: CN≤1μF: 10kHz; CN>1μF: 1kHz Voltage proof between terminals: 4.3UR(d.c.), 1min IR. test voltage: 100Vd.c.	Within specified tolerance
	4.2.3 Tangent of loss angle		No permanent breakdown or flashover
	4.2.1 Voltage proof		
	4.2.5 Insulation Resistance		I.R.: ≥the rated value
B1	4.5 Solderability	Methods: Groove welding Ta, Method 1 Solder temperature: 245°C±5°C Immersion time: 2.0s±0.5s	Good quality of tinning
C1A	Initial measurement	Dimensions: gauging by vernier caliper Measuring frequency: Capacitance: 1kHz Tangent of loss angle: CN≤1μF: 10kHz; CN>1μF: 1kHz	No visible damage & legible marking
			Fit detail specification
			Within specified tolerance
			Creepage distances ≥4.0mm Clearances ≥3.0mm
	4.1.1 Creepage distances and Clearances	Gauging by vernier caliper	
	4.3 Robustness of Terminations (straight lead)	Tense: 0.50 < d ≤ 0.80, 10N 0.80 < d ≤ 1.25, 20N Ub bending test: Bend: 0.50 < d ≤ 0.80, 5N 0.80 < d ≤ 1.25, 10N The terminals shall be bent 2 times in each direction	No visible damage
	4.4 Resistance to Soldering heat	Capacitors are not pre-dried Groove Method Tb, Method 1A Solder temperature: 260°C±5°C Immersion time: 10s±1s	No visible damage & legible marking
4.19 Component solvent resistance	Solvent: industrial isopropyl Solvent temperature: 23°C±5°C Dipping time: 5min±0.5min Method 2: (without Sassafras test) Recovery time: 48h	Comply with the specifications in the product size table	
	Final measurement	Appearance inspection Cap. measuring frequency: 1kHz Tangent of loss angle: CN≤1μF: 10kHz; CN>1μF: 1kHz	No visible damage Cap.: ΔC / C ≤ 5% Tangent of loss angle: CN≤1μF: ≤ 0.008 (10kHz) CN>1μF: ≤ 0.005 (1kHz)



Group	Item	Conditions of test	Performance requirements	
C1B	Initial measurement	4.1 Visual examination	No visible damage & legible marking	
		4.1 Dimensions (Gauging)		Dimensions: gauging by vernier caliper
		4.2 Capacitance		Measuring frequency: Capacitance: 1kHz Tangent of loss angle: $C_N \leq 1\mu\text{F}$: 10kHz; $C_N > 1\mu\text{F}$: 1kHz
		4.2.3 Tangent of loss angle		Fit detail specification
	4.5 Solderability	Methods: Groove welding Ta, Method 1 Solder temperature: $245^\circ\text{C} \pm 5^\circ\text{C}$ Immersion time: $2.0\text{s} \pm 0.5\text{s}$	Within specified tolerance	
	4.20 Solvent resistance of the marking	Solvent: Industrial isopropanol. Solvent temperature: $23^\circ\text{C} \pm 5^\circ\text{C}$ Dipping time: $5\text{min} \pm 0.5\text{min}$ Condition: scrub Scrub material: absorbent cotton Reverting time: No	Good quality of tinning	
	4.6 Rapid change of temperature	$T_A = -40^\circ\text{C}$, $T_B = +110^\circ\text{C}$ 5 cycles, Duration: $t=30\text{min}$	The marking shall be legible	
	4.7 Vibration (straight lead)	Amplitude 0.75mm or acceleration 98m/s^2 (whichever is the smaller severity), f: 10Hz to 500Hz. Three directions, 2h for each direction, total 6h.	No visible damage	
4.8 Bump (straight lead)	4 000 times, Acceleration: 400m/s^2 , Pulse duration, 6ms	No visible damage		
	Final measurement	Appearance inspection Cap. measuring frequency: 1kHz	No visible damage Cap.: $ \Delta C /C \leq 5\%$	
C1	4.11 Climatic sequence	Initial measurement	According to the requirements of Group C1A and C1B	
		Dry heat	+110°C, 16h	
		Damp heat, Cyclic	Test Db, Severity: b, the first cycle Temperature: +55°C, 24h each cycle, Method 2	
		Cold	-40°C, 2h	
		Damp heat, Cyclic	Test Db, Severity b, the other cycles Temperature: +55°C, 24h each cycle, Method 2	
		Final measurement	Measuring frequency: Capacitance: 1kHz Tangent of loss angle: $C_N \leq 1\mu\text{F}$: 10kHz; $C_N > 1\mu\text{F}$: 1kHz Voltage proof between terminals: 4.3 U_R (d.c.), 1min Voltage proof between terminal and housing: $2U_R + 1500\text{V}$ (a.c.), 1min Insulation resistance test voltage: 100Vd.c.	According to the requirements of Group C1A and C1B
		No visible damage & legible marking		
		Cap.: $ \Delta C /C \leq 5\%$ Increase of $\text{tg}\delta$: $C_N \leq 1\mu\text{F}$: ≤ 0.008 (10kHz) $C_N > 1\mu\text{F}$: ≤ 0.005 (1kHz) No permanent breakdown or flashover I.R.: $\geq 50\%$ of the rated value		





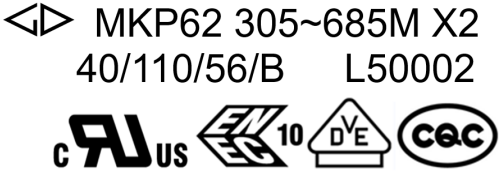

Group	Item	Conditions of test	Performance requirements
C2	4.12 Damp heat, steady state	Temperature: 40°C ±2°C Humidity: 93±3%RH Duration: 56 days	No visible damage & legible marking Cap.: ΔC /C ≤5% Increase of tgδ: C _N ≤ 1μF: ≤0.008 (10kHz) C _N > 1μF: ≤0.005 (1kHz) No permanent breakdown or flashover I.R.: ≥50% of the rated value
	Final measurement	Tangent of loss angle: C _N ≤ 1μF: 10kHz; C _N > 1μF: 1kHz Voltage proof between terminals: 4.3U _R (d.c.), 1min Voltage proof between terminal and housing: 2U _R +1500V(a.c.), 1min Insulation resistance test voltage: 100Vd.c.	
C3	Initial measurement	Measuring frequency capacitance: 1kHz Tangent of loss angle: C _N ≤ 1μF: 10kHz; C _N > 1μF: 1kHz Insulation resistance test voltage: 100Vd.c.	Within specified tolerance
	4.13 Impulse voltage	Each individual capacitor shall be subjected to 24 impulses of the same polarity, the time between impulses shall not be less than 10S, and the peak value of the voltage impulse: 2.5kV (suitable for C _N ≤ 1μF; When C _N > 1μF, the capacitor can endure pulse voltage value is 2.5/√C _N kV)	There are three or more waveforms which indicate that no self-heating breakdown have occurred when it is monitored by the monitor (when any three successive impulses are shown by the monitor to have a wave form indicating that no self-healing breakdown have taken place the impulses can be stopped)
	4.14 Endurance	Temperature : +110°C Duration : 1000h Voltage: at 1.25 U _R	No visible damage & legible marking Cap.: ΔC /C ≤10% Increase of tgδ: C _N ≤ 1μF: ≤0.008 (10kHz) C _N > 1μF: ≤0.005 (1kHz) No permanent breakdown or flashover I.R.: ≥50% of the rated value
	Final measurement	Tangent of loss angle: C _N ≤ 1μF: 10kHz; C _N > 1μF: 1kHz Voltage proof between terminals: 4.3U _R (d.c.), 1min Voltage proof between terminal and housing: 2U _R +1500V(a.c.), 1min	

Group	Item	Conditions of test	Performance requirements
C4	4.15 Charging and discharging	Times: 10 000 Duration of charging: 0.5s Duration of discharging: 0.5s Charging voltage: $\sqrt{2}U_R$ Vd.c. Charging resistance: $220/C_N(\Omega)$ or the current $\leq 1.0A$ (whichever is the minor) Discharging resistance: $R = \frac{\sqrt{2}U_R}{C_N \times \frac{dU}{dt}} (\Omega)$ C_N : Capacitance (μF) $dU/dt(V/us)$: 100V/ μs	Cap.: $ \Delta C /C \leq 10\%$ Increase of $tg\delta$: $C_N \leq 1\mu F$: ≤ 0.008 (10kHz) $C_N > 1\mu F$: ≤ 0.005 (1kHz) I.R.: $\geq 50\%$ of the rated value
C6	4.17 Passive flammability	Needle flame test The category of flammability: B Expose time: 1 time Capacitor Volume Exposing time $250 < V(mm^3) \leq 500$ 20s $500 < V(mm^3) \leq 1750$ 30s $V(mm^3) > 1750$ 60s	The flaming time of each capacitor shall not go beyond 10s after it is taken apart from the flame. Drop of each capacitor caused by flame shall not fire the tissue below.
C7	4.18 Active flammability	The specimens shall be individually wrapped in at least 1, but not more than 2, complete layers of cheesecloth, the cheesecloth shall be untreated pure cotton cloth. Each sample shall be subjected to 20 discharges, the interval between successive discharges shall be 5s. $U_i = 2.5kV_0^{+7}\%$ U_R be applied and be maintained for 120_0^{+10} s after the last discharge.	The cheese cloth around the capacitor shall not burn with a flame.

■ Marking (For example)

	
<p>Fig.1 P ≤ 27.5mm</p>	<p>Fig.2 P > 27.5mm</p>

Marking Introduction

Sign	explain	Sign	explain
	Brand		ENEC-VDE Approval
MKP62	Type		CQC Approval
305~	Rated voltage		UL,CUL Approval
X2	Class	40/110/56/B	Climate category / Passive Flammability Class
474M 685M	Rated capacitance and tolerance	L50002	Lot No.

■ Taping specification for box-type capacitors

▲ Outline Drawing

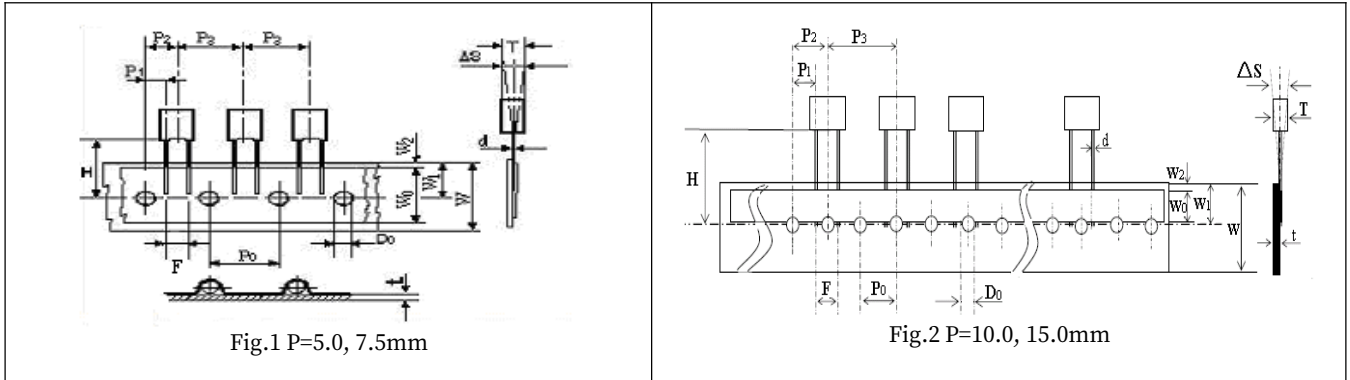

Fig.1 P=5.0, 7.5mm

Fig.2 P=10.0, 15.0mm

▲ Taping Dimensions(mm)

Technology index title	Code	Dimensions				
		P=5.0	P=7.5	P=10.0	P=15.0	Tolerance
Taping type	—	Fig 1	Fig 1	Fig2	Fig 2	—
Part number Digit12-15	Ammo- pack	A201	A301	A405	A605	
Taping pitch	P_3	12.7	12.7	25.4	25.4	± 1.0
Feed hole pitch	P_0	12.7	12.7	12.7	12.7	± 0.3
Center of wire	P_1	3.85	2.6	7.7	5.2	± 0.7
Center of body	P_2	6.35	6.35	12.7	12.7	± 1.3
Pitch of taping wire	F^{**}	5.0	7.5	10.0	15.0	+0.6 -0.1
Component alignment	ΔS	0	0	0	0	± 2.0
Height of component from tape center	H^{***}	18.5	18.5	18.5	18.5	± 0.5
Carrier tape width	W	18.0	18.0	18.0	18.0	+1.0 -0.5
Hold down tape width	W_0	6min	10min	10min	10min	—
Hole position	W_1	9.0	9.0	9.0	9.0	± 0.5
Hold down tape sition	W_2	3max	3max	3max	3max	—
Feed hole dia.	D_0	4.0	4.0	4.0	4.0	± 0.2
Tape thickness	t	0.7	0.7	0.7	0.7	± 0.2

Note: * $P_0=15mm$ is also available;

**F can be other lead spacing;

***H=16.5mm is available;

■ Soldering suggestions

- ▲ Manual soldering
Max. temperature: 350°C, time: 3s
- ▲ Wave soldering

There are many factors affecting the heating of film capacitor during the wave soldering process, such as: preheating temperature, preheating time, soldering temperature, soldering time, other heat sources influence and so on.

The typical soldering profile is as below:

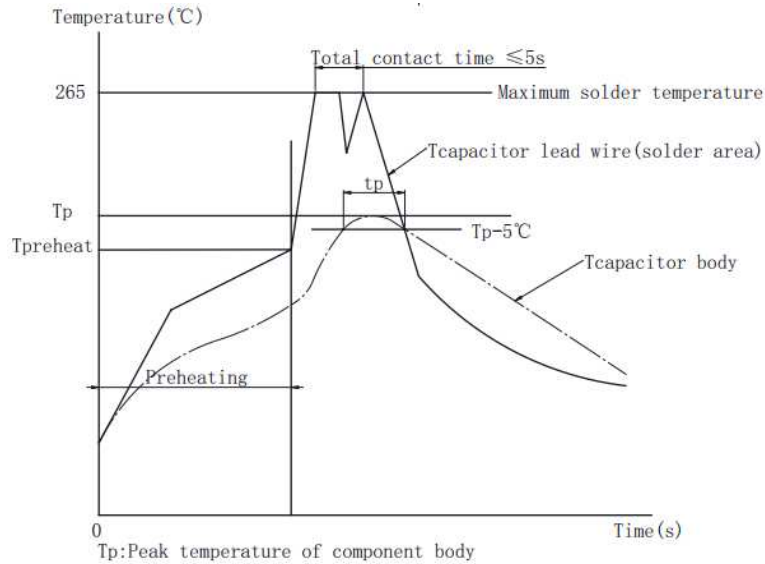

▲ Because overheating could damage the capacitor, we recommend paying attention to the maximum capacitor temperature and heating time, use temperature sensor to detect the maximum capacitor body temperature.

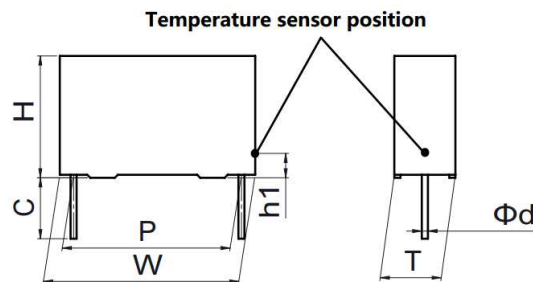

Note: If re-working or dipping twice is necessary, it should be done after the capacitor returns to the normal temperature.

Temperature sensor position ($T_{\text{capacitor body}}$)	The capacitor body surface of lead side, capacitor height position from PCB: $h_1=2\sim 3\text{mm}$		
Maximum capacitor body temperature $T_p(^{\circ}\text{C})$	OPP film $P \leq 15\text{mm}$	OPP film $P > 15\text{mm}$	PET film
Maximum capacitor lead wire temperature ($^{\circ}\text{C}$)	265	265	265
Maximum capacitor body heating time $t_p = T_p - 5^{\circ}\text{C}$	30s		

■ Packing box sizes(mm)(example)

1. Out packing box for bulk

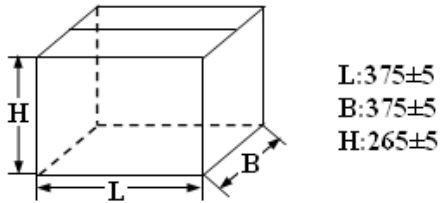

2. Inner packing box for bulk

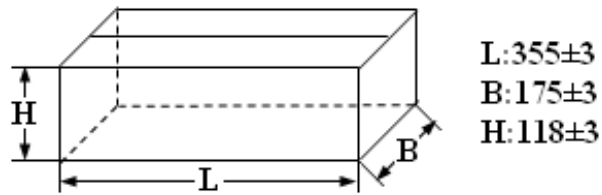

3. Box sizes for Ammo-pack

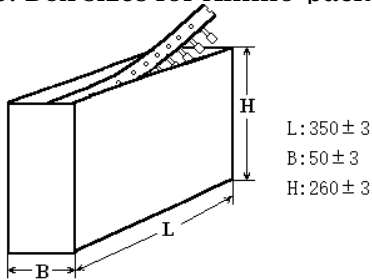

■ Storage conditions

▲ It must be noted that the solderability of the terminals may be deteriorated when stored in an atmosphere filled with moisture, dust, or a reactive oxidizing gas.(hydrogen chloride, hydrogen sulfide, sulfuric acid,etc.)

▲ It shouldn't be located in particularly high temperature and high humidity, it must submit to the following conditions(unchanging primal package):

Temperature: -40 °C to 35 °C

Humidity: Average per year ≤70%RH;

For 30 full days randomly distributed throughout the year ≤80%RH

Storage time for tinned lead wire: (from the date marked on the capacitor's body or the label glued to the package) :

Bulk(packed with plastic bag): ≤24 months ;

Taping and line up: ≤12 months