

(W/O COVER)

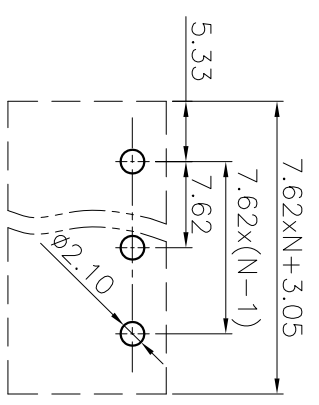

PCB LAYOUT

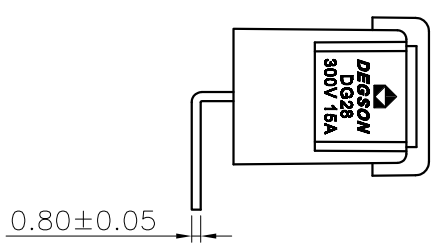
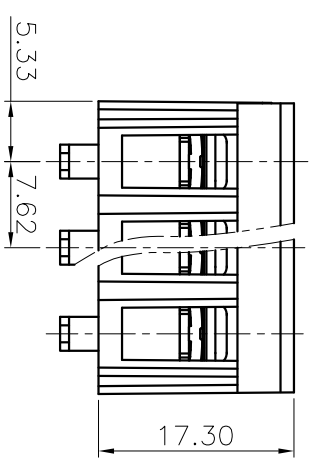
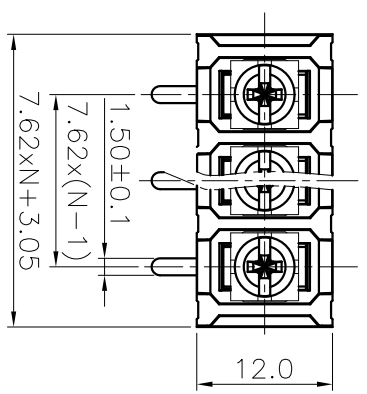
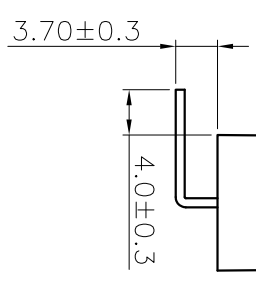
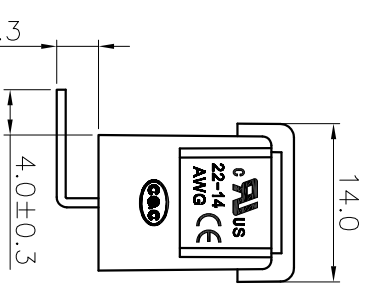

REVISION RECORD			
REV	ECN	DESCRIPTION	DRFT DATE

NOTES1:

- UL Standard
- Rated voltage/current : 300V / 15A
- Torque value : M3 , 4.43Lb.in
- Wire range : 22~14AWG

NOTES2:

- Dimension shall be interpreted per ASME Y14.5-2009
- Pitch : 7.62mm, Poles : N=02~26P
- Withstanding voltage : AC1600V/1Min
- Operating temperature: -40°C~+105°C
- Undimensioned tolerances:

Pitch range	in		mm		Over	Over	Over	Over	Over
	mm	in	mm	in					
6	0.236	0.236	1.5	0.059	0.1	0.1	0.1	0.1	0.1
10	0.394	0.394	2.5	0.098	0.1	0.1	0.1	0.1	0.1
15	0.591	0.591	3.8	0.150	0.1	0.1	0.1	0.1	0.1
24	0.945	0.945	6.0	0.236	0.1	0.1	0.1	0.1	0.1
30	1.181	1.181	7.6	0.299	0.1	0.1	0.1	0.1	0.1
60	2.362	2.362	15.2	0.598	0.1	0.1	0.1	0.1	0.1
100	3.937	3.937	25.4	1.000	0.1	0.1	0.1	0.1	0.1
150	5.906	5.906	38.1	1.500	0.1	0.1	0.1	0.1	0.1
±2'									

6. RoHS Compliance

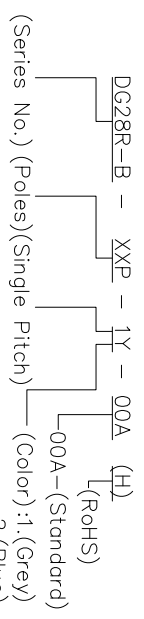

- (Series No.) (Poles) (Single Pitch)
- 00A - (Standard)
- 00A - (Color) : 1. (Grey)
- 2. (Blue)
- 3. (Black)
- 4. (Green)
- 5. (Orange)
- 6. (Red)
- 7. (Transparent)
- 8. (Yellow)
- 9. (White)

DETACHED LISTS			
PART NO.:	/	NAME:	DEGSON® NINGBO DEGSON ELECTRICAL CO., LTD 宁波高松电子有限公司
APPD:	/	TITLE:	CUSTOMER DRAWING
CHKD:	/	DRAWING NO.:	/
DRFT:	/	REV	DO
THIRD ANGLE PROJECTION		DO NOT SCALE DRAWING	SCALE
			1:1